



Homeefe

DOORS • WINDOWS • FLOORING

INTERNAL DOORS



CHANGE YOUR LIFE WITH OUR DOORS

CONTENTS

The right door for you	6
Colours	8
Glazing types	10
Door opening direction	11
Door leaf structure	13
Symbols	18
Internal doors	23
- BRILLIANT Collection	23
- PRESTIGE Collection	41
- BASIC Collection	81
Front internal doors	107
Tailor-made doors	119
Frames and accessories	143
Door handles	166
Accessories	174
Specifications	178

BRILLIANT COLLECTION



BA p. 24

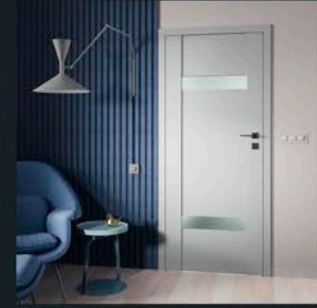

BB p. 26



BC p. 28

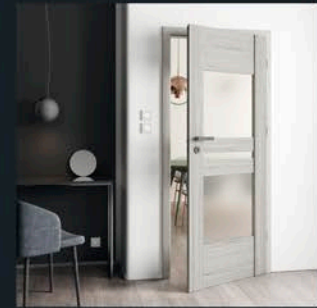

BD p. 30



BE p. 32

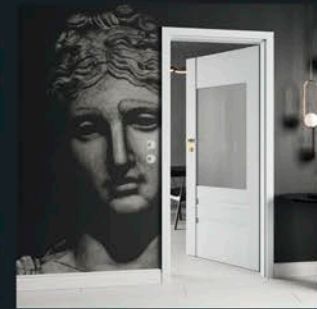

BF p. 34



BG p. 36

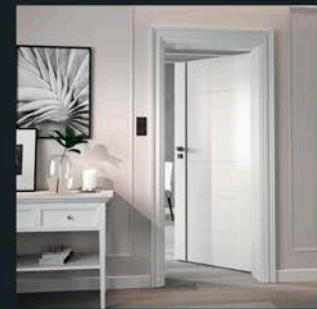

BO p. 38

PRESTIGE COLLECTION



PA p. 42



AN p. 44



PB p. 46

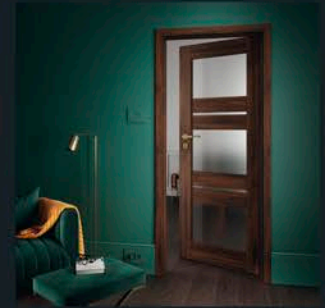

PC p. 48

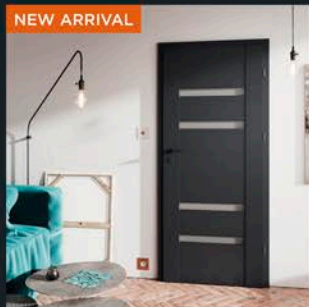

PE p. 50



PH p. 52



PI p. 54



PJ p. 56

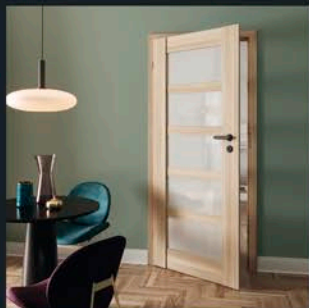

PK p. 58

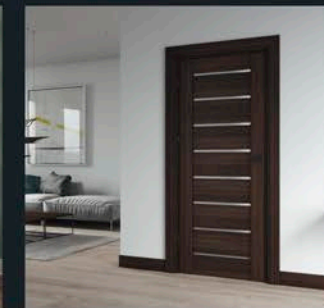

PL p. 60

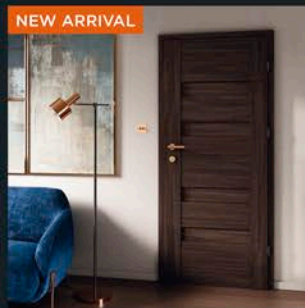

PN p. 62

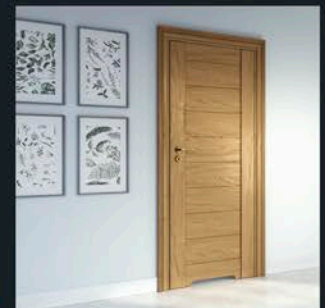

PO p. 64



PP p. 66

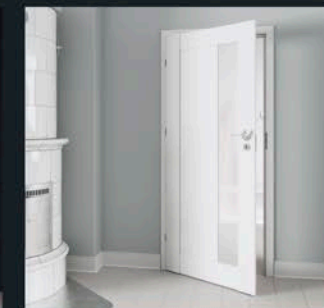

PR p. 68

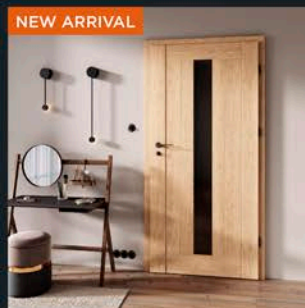

MI p. 70



PT p. 72



PU p. 74

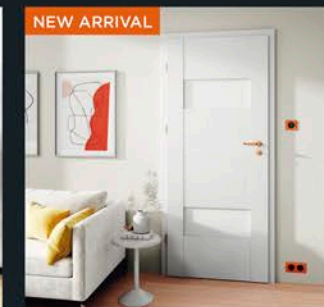

PW p. 76



PZ p. 78

BASIC COLLECTION



INTERNAL FRONT DOORS



TAILOR-MADE DOORS



SIMPLE non rebated door system p. 120

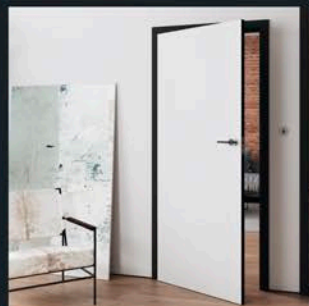

CONTRAST door system p. 122



Reversible doors p. 123

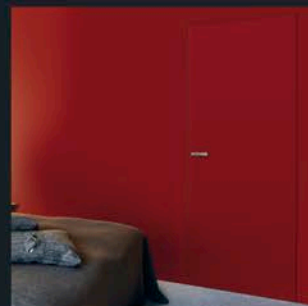

INVISIBLE wall-flush doors p. 124



Doors with slanted corners p. 126

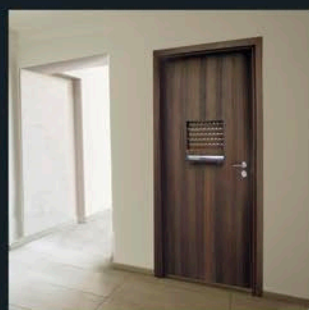

INSET doors with hatches p. 127



SWING doors p. 128



Double doors p. 130



Wall-mounted sliding doors p. 136

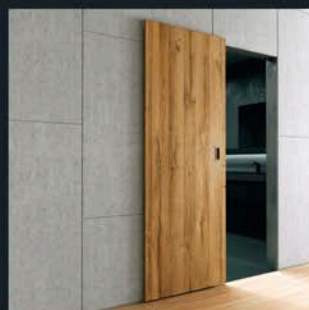

MAGIC wall mounted sliding doors p. 134

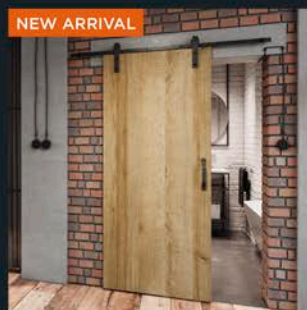

LOFT wall mounted sliding doors p. 136

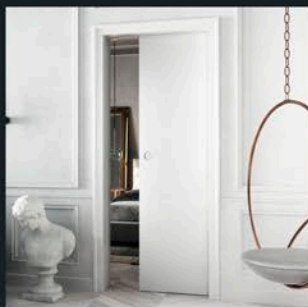

In-wall sliding doors p. 138

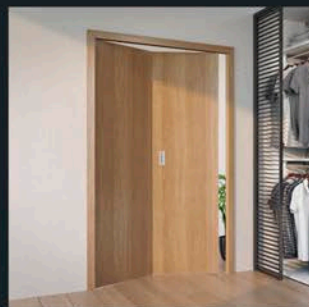

FOLD folding doors p. 140

THE PERFECT DOOR? CHOOSE ONE FROM HOMEEFE!

The right door for you

Refurbishing and furnishing your dream home is usually a costly experience. One which can be overwhelmingly emotional! Obviously, we seek “the perfect solution” when designing our home or office. We search for what we have pictured in our mind, so that it fits perfectly into place. Choosing that unique door seems as though it should be an easy process, especially with the extensive choice currently available on the market. But is it? There are still many choices to make: Traditional swinging door or sliding? Single or double leaf? Opening to the left or to the right?

Should they match the colour of the floor, the walls or the windows? Glazed or solid? The new edition of the Homeefe Product Catalogue is here to help you sort through these and many more dilemmas. It is easy to navigate and clear to read, with all the information you need about our wide selection of solutions, created to match the latest interior design trends. We hope that our 35 years of experience will inspire you whilst seeking that perfect door, featuring design and problem-free performance to satisfy you for decades to come.

A WIDE RANGE

We closely follow the trends in

construction and interior design to continuously develop new products and keep our range in touch with your needs. Our well-loved Prestige, Basic and Solid door collections now have some new arrivals.

MEETING THE HIGHEST EXPECTATIONS: THE NEW BRILLIANT COLLECTION

Modern lines, minimalist design, and a refined feel. Brilliant includes doors without compromise in design and performance. The best solutions combined with the most unique trends in modern utility design. Our new composite structure has improved mechanical strength and durability, and features VSG composite glass and

a new hinge design, with a selection of intriguing colours. The Brilliant Collection doors are bound to showcase any refined interior design.

COLOURS MATTER

Choosing the perfect colour for your doors usually means matching them to the predominant colours on the walls or floors, or attempting a contrast. It is less popular to match the door colour to that of the furniture or décor. Whatever your colour-matching philosophy, you are sure to enjoy the selection of unique colours in the latest Homeefe Product Catalogue. If you are looking to make the doors look almost invisible by blending them into the wall, look no further than

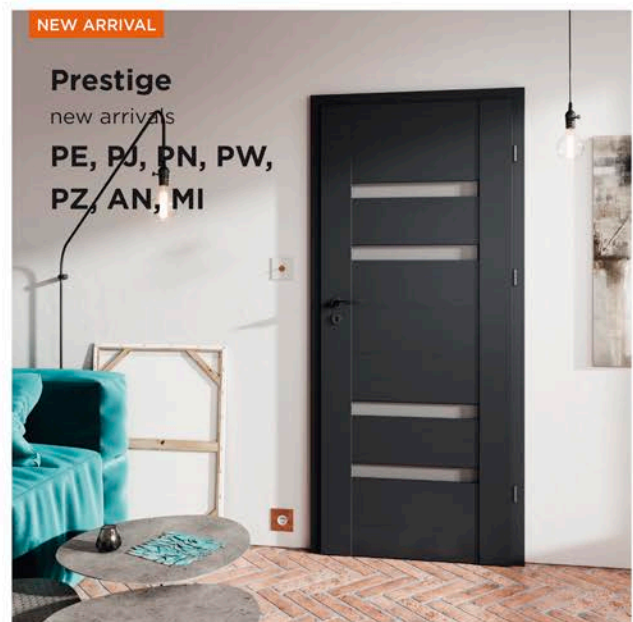



Contrast
system



Reversible
doors

the Invisible range: non-rebated doors finished with a veneer that can be painted or wallpapered over.

STEEL FRAMES

A frame fulfills the same role for a door as for a painting: it encloses it and provides a sense of completion. It highlights the style and the feel of the room. A steel frame is perfect for homes, office areas and public buildings which require extremely heavy-duty door systems that can withstand abuse and corrosion. Available in many colour options, the steel frames fit perfectly in any interior design.

DOOR HANDLE: THE DIFFERENCE IS IN THE DETAIL

The look and feel of a door is not

only defined by its thermoforming veneer, glazing or frame design, but also by the handle. A seemingly small yet eye-catching detail. It must be convenient, easy to use and well designed. Traditional, progressive, white, nickel-plated, satin-finished, or all-black? Explore the latest range of door handles, designed to add that final yet important touch to Homeefe doors.

“TAILOR-MADE DOORS”

When there is nothing on the market to match your vision of the perfect door. Non-standard clear heights or widths (or both), a slanted ceiling in the attic, a small room which demands a sliding or in-wall sliding door? We already

have you covered. If there is nothing suitable in the standard, off-the-shelf range of Homeefe products, consult with Homeefe for a tailor-made solution. Homeefe provides an extensive choice of customisation options: from the perfect size and type of door opening to the finish design features, including colours, hardware and glazing designs.

Here we highly recommend the latest CONTRAST door system, featuring edging which contrasts with the door leaf surface, reversible doors, and our minimalist, wall-mounted MAGIC sliding doors with their concealed running mechanism.



NEW ARRIVAL

BASIC
ASTORIA
GOLD

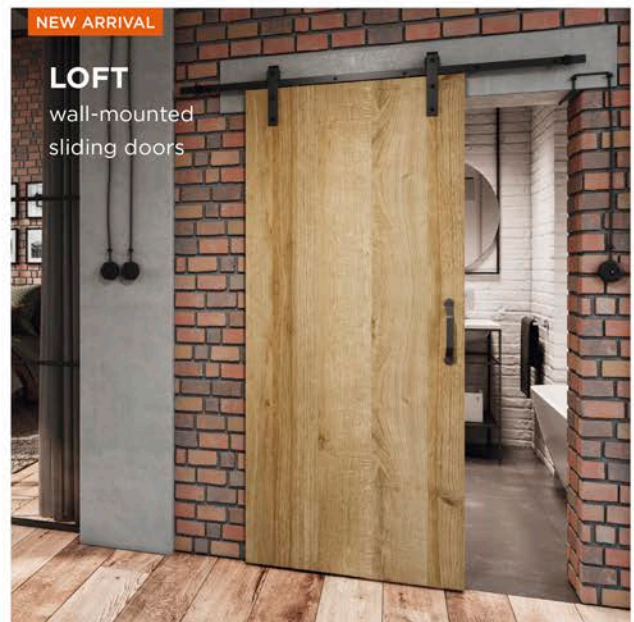

NEW ARRIVAL

LOFT
wall-mounted
sliding doors

COLOUR OPTIONS

PVC GROUP

Door leaves and frames are finished with a high-quality PVC veneer with a woodgrain pattern (not applicable to Super-flat Grey). This finish boasts a high resistance to damage, staining and UV light, making the doors a perfect choice for homes and buildings open to the public. Adjustable door frames are produced in the PP color group.



Textured White



Super-flat Grey



Natural Grandson Oak

PP GROUP

Doors are finished with polypropylene veneer with a heat-cured clear coat to improve scratch resistance. These are high-quality products which perform well in high-traffic areas and residential buildings.

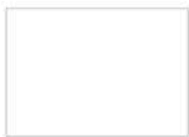

Super-flat White



Textured White



Super-flat Grey

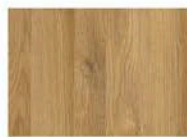

Natural Grandson Oak

CPL GROUP

Doors are finished with a high-quality two-ply laminate, which comprises of a heat-cured resin-sealed paper together with a base ply for improved flexibility. The laminate material features a high level of surface hardness with scratch and abrasion resistance. The textured finishes available in Radiant Grey and Italian Walnut provide the look and feel of real wood.

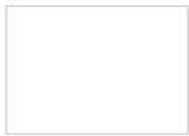

Uni White



Uni Grey



Radiant Grey



Uni Anthracite



Italian Walnut



Black Uni

CLPL GROUP

Doors are finished with a high-quality two-ply laminate, which comprises of a heat-cured resin-sealed paper together with a base ply for improved flexibility. The laminate material features a high level of surface hardness with scratch and abrasion resistance. The textured finishes available in Radiant Grey and Italian Walnut provide the look and feel of real wood.

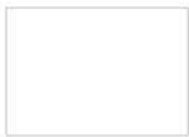

Flat White



Whitewash Larch



Honey Oak



Grey Larch

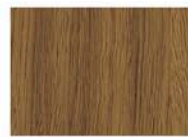

Spanish Oak



Vintage Oak

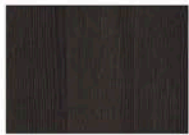

Black Larch

FF GROUP

Door leaves and frames are covered with a scratch-resistant veneer with a woodgrain pattern. They are built with care and designed to last, an ideal choice for anyone searching for the perfect solution.

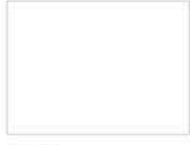

Bianco



Sibiu White



Silver Oak



Cornwall Oak



Halifax Oak



Colombian Walnut



Sonoma Oak



Riviera Oak

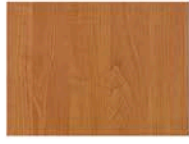

Bavarian Alder



California Oak

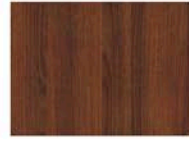

Sicilian Walnut

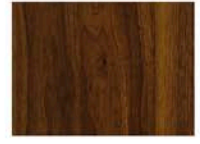

Nussbaum Walnut

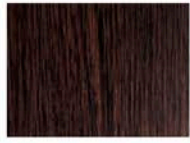

Mountain Wenge

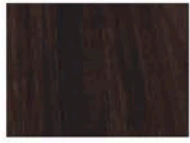

Bengali Mango

LAK GROUP

Door leaves are finished with a HDF veneer protected with a UV and scratch-resistant coat. They are easy to maintain and reliable for years to come. A unique feature of this colour group is the slight variation in colour between the door leaf, frame, finish trim and glazing beading.

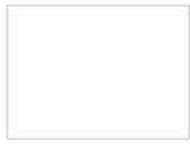

White



Whitewash Oak



Silver Oak



Nordic Elm



Oak

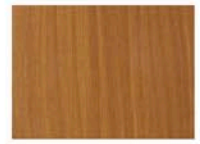

Alder



Walnut

All colours in this catalogue are reproduced with a special printing technology. Due to its limitations, the colours shown here might vary from the actual one. Your perception of colour can also be affected by illumination, surface type and texture, and ambient colour.

GLAZING TYPES



Satin tempered



Bevelled Satin tempered



Bevelled clear tempered



Satin VSG 2.2.1



Bevelled Satin VSG 2.2.1



Bevelled Clear VSG 2.2.1



Satin deco

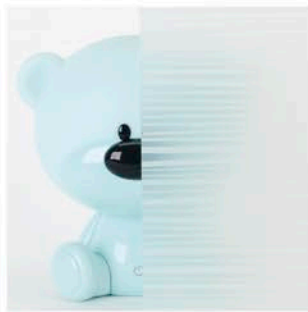

Satin lines

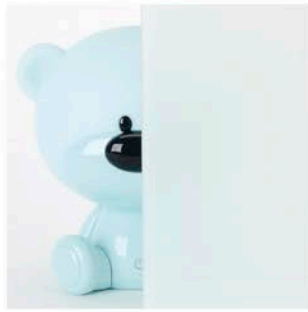

Lacomat*



Chinchila

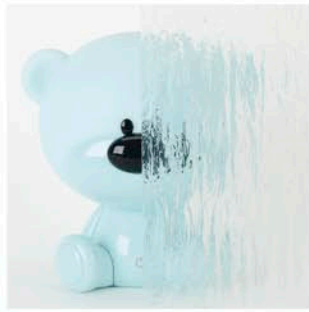

White coloured



Satin macadi temperedSatin



Satin sapporo tempered



Black VSG 2.2.1



Black Lacobel



Gold Lacobel

DOOR OPENING DIRECTION

SINGLE DOOR

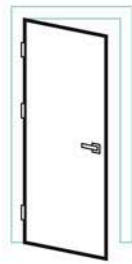

left hand



right hand

REVERSIBLE



left hand

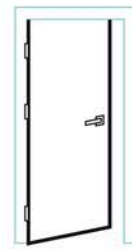

right hand

DOUBLE DOOR



left hand

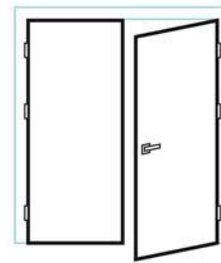

right hand

FOLD FOLDING DOOR



left hand



right

SLIDING

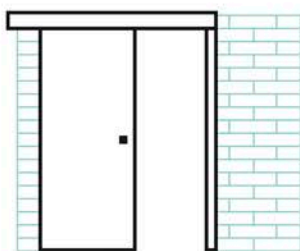

to the left

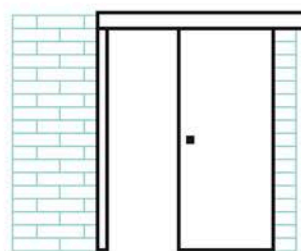

to the right

Why did we create the Brilliant Collection?

We wanted to redefine the Homeefe door. Starting with a clean slate, we created doors that we would enjoy using every day. Our goal was to design a whole new series of products, one that would be an uncompromising fusion of the best technological solutions together with the most exciting trends in contemporary utility design. This is the Brilliant Collection: modern, minimalist and refined.

We took great efforts to ensure all the components worked together in harmony.

The Brilliant door stile is an all-new composite structural design which combines the best of pine and MDF: low weight, high stress strength and uniform resistance to mechanical failure. To offset the forces applied to the door leaf, we completely overhauled the stile tie design. Each panel is secured with fixing plugs and the inner ties are now redesigned to be the full width of the head and bottom ties, which themselves are now bulkier for improved structural rigidity. The frame structure for Brilliant doors is Homeefe's most durable design.

Safety first! That's why Brilliant doors feature the industry's highest standard of glazing: laminated VSG glass. VSG glass combines all the features we were looking for: a safe and durable design with a smooth surface on both sides for a consistent user experience, irrespective of the opening direction.

The new design had to be compatible with the all new hinges, which are now much larger than their predecessors and can withstand loads of up to 60 kg. To harmoniously compliment with modern styles, in addition to their nickel-plated counterpart, we have included a special all-black hinge for the first time.

Our colour palette has also been revolutionised. The Brilliant Collection features tones that redefine the entire door and window industry. Two new colour groups were created. PP-group polypropylene film and high-quality CPL-group laminate materials.

The PP group comprises of four designs of thermoforming veneer, which provide the best minimalist and refined features. Super-flat White and Super-flat Grey are perfect for contemporary indoor designs, which suit Brilliant doors perfectly. To accentuate the indoor fitout style and set its interior design and atmosphere, woodgrain films are recommended in Textured White or the elegant and warmer Natural Grandson Oak.

The CPL group includes discernably wood-inspired laminates: the delicate, cool and bright Radiant Grey as well as the ever-trendy, vintage Italian Walnut. Out of appreciation for minimalism, we included solid colours too: the classic Uni White and Uni Black along with the more progressive Uni Grey and Uni Anthracite.

We are sure that natural wood finishes are here to stay. Timeless options include the Italian veneers in the

CLCP group, featuring the rich and perfect qualities of natural timber.

Discover the unique Brilliant Collection for minimalism without compromise.



- 1. vertical component made of wood - MDF composite**
- 2. transverse MDF panels - all of the same thickness**
- 3. ornament or glass infill**
- 4. wood dowels**
- 5. stabilising tongues**

DOOR LEAF STRUCTURE

BRILLIANT FRAME DOORS

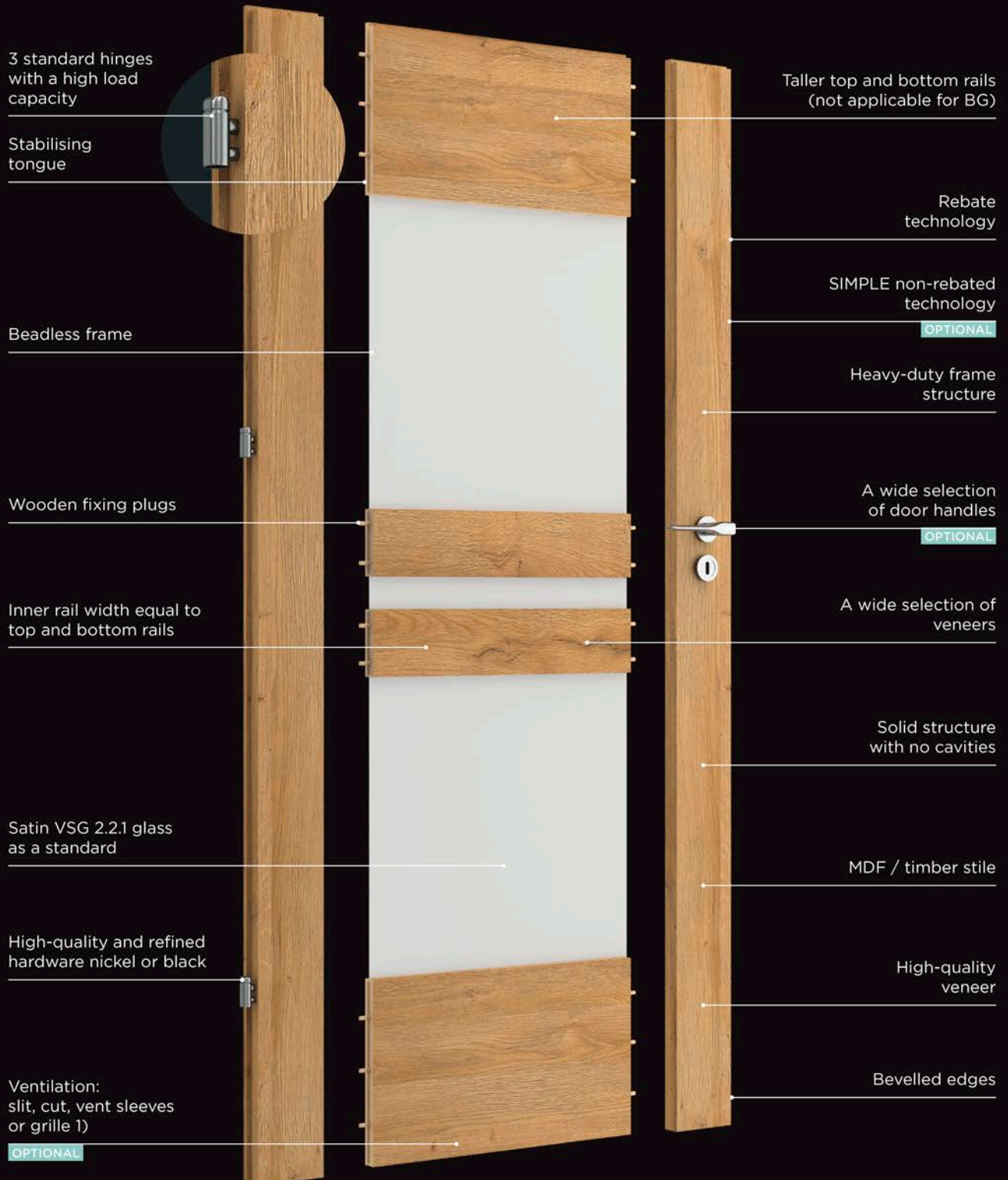

1) Ventilation grille available for doors of width 80 or wider

DOOR LEAF STRUCTURE

PRESTIGE FRAME DOORS

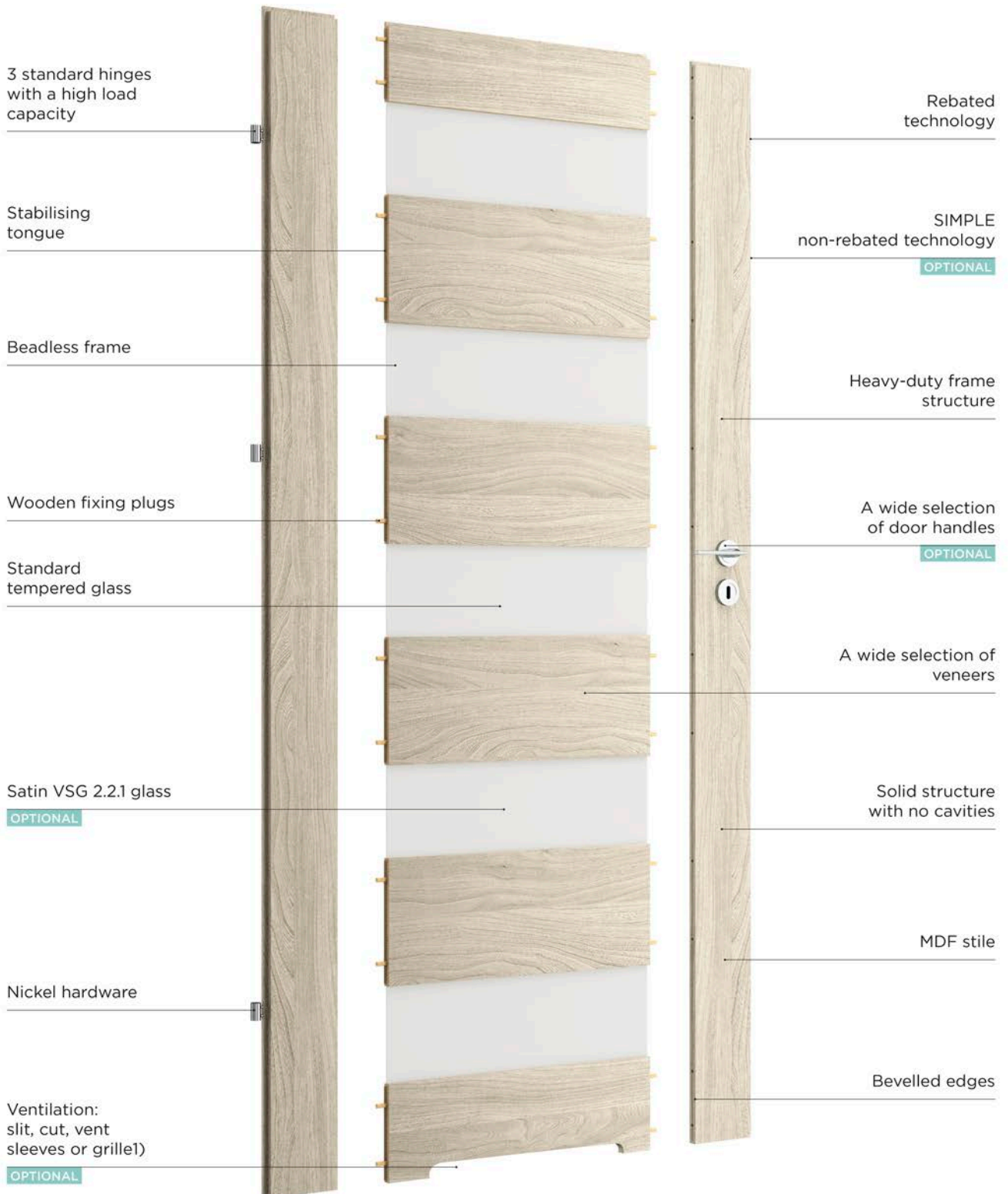

1) Door grilles available for doors of width 80 or wider

DOOR LEAF STRUCTURE

BASIC FLUSH DOORS

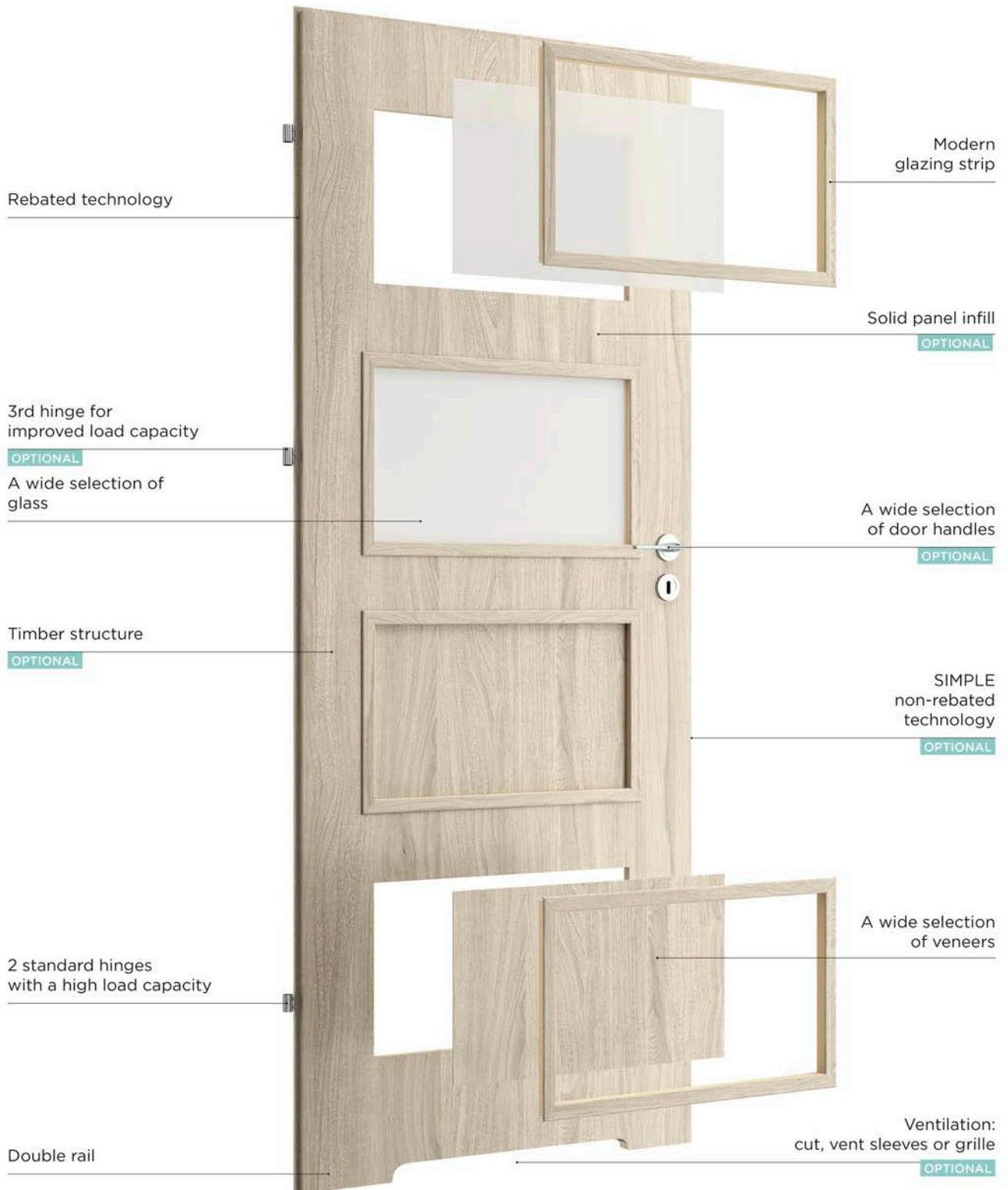

TYPES OF DOOR LEAF STRUCTURE

FRAME STRUCTURE

The BRILLIANT and PRESTIGE Collections are not just about unique style, but also heavy-duty and highly durable design, based on the frame structure used in all models. The structure is solid, stress-resistant and constructed using engineered wood panels, plus additional timber parts in some models. All parts are solid and the joints are made using plugs and stabilizer tongues which ensure heavy duty performance and high stability. The frame structure allows for the the door height to be trimmed by up to 30 mm.



Frame structure



1. film or glass infill
2. solid and heavy MDF structure or (in PRESTIGE models) or timber + MDF structure (in BRILLIANT models)
3. wooden fixing plugs
4. stabilizer tongues

MDF STRUCTURE

The structure is based on robust MDF stiles and rails with bracing and reinforcing infill made from a honeycomb panel. The outer lining is made from 3 mm HDF panel finished with the chosen veneer. The double rail at the bottom of the door allows for its height to be trimmed by up to up to 30 mm.



MDF structure

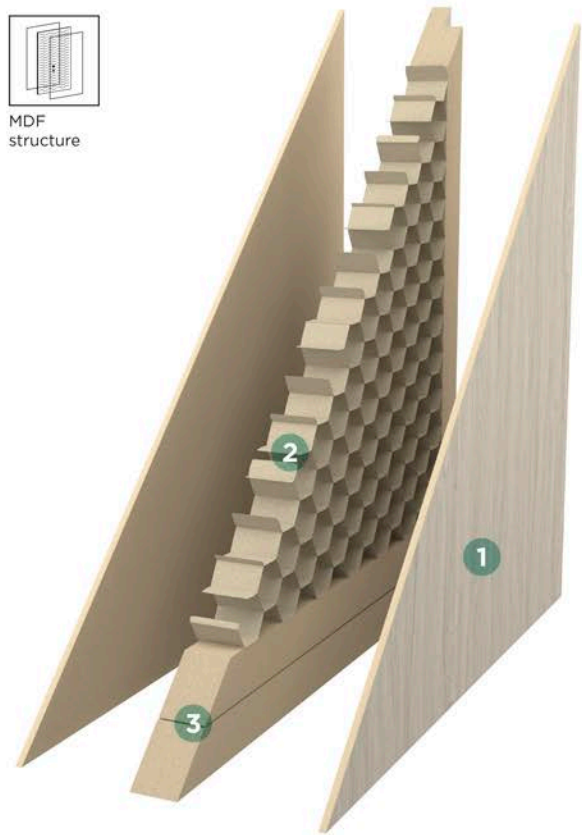

1. outer HDF lining
2. bracing and reinforcing honeycomb infill panel
3. double MDF rail

TIMBER STRUCTURE

The BASIC door design is a robust and ever-popular solution. The structure is constructed using soft wood stiles. The bracing and reinforcing infill is a honeycomb panel. The outer lining is made from 3 mm HDF panel finished with the chosen veneer. The double rail design allows for the door height to be trimmed by up to 60 mm.

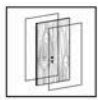

Timber structure

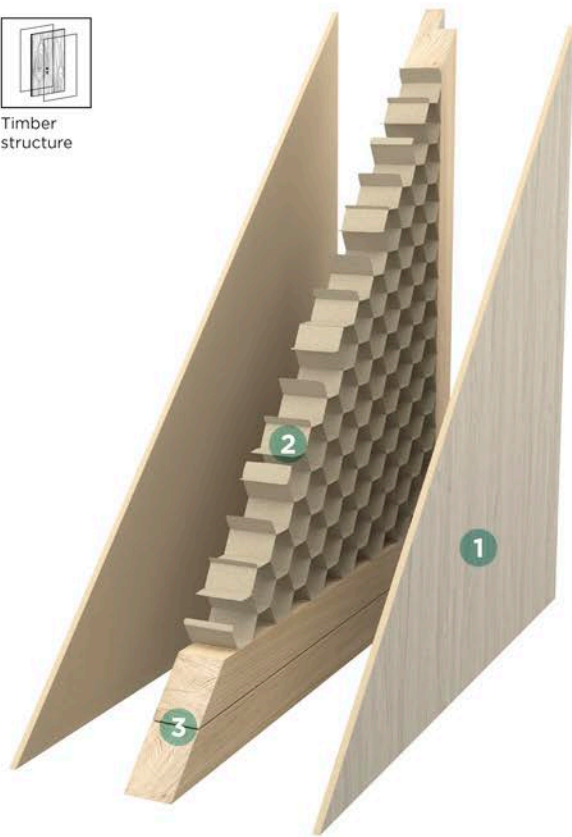

1. outer HDF lining
2. bracing and reinforcing honeycomb infill panel
3. double rail of soft wood

SOLID PANEL INFILL DESIGN

A solid panel infill provides a very durable and strong door leaf. The structure is based on timber stiles and rails with a solid panel in between. The outer cladding is made from 3 mm HDF panel, finished with a thermo-forming film from the selected colour group. With the double rail at the door bottom, the door leaf can be trimmed in height by up to 60 mm.

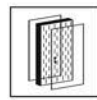

Heavy-duty infill

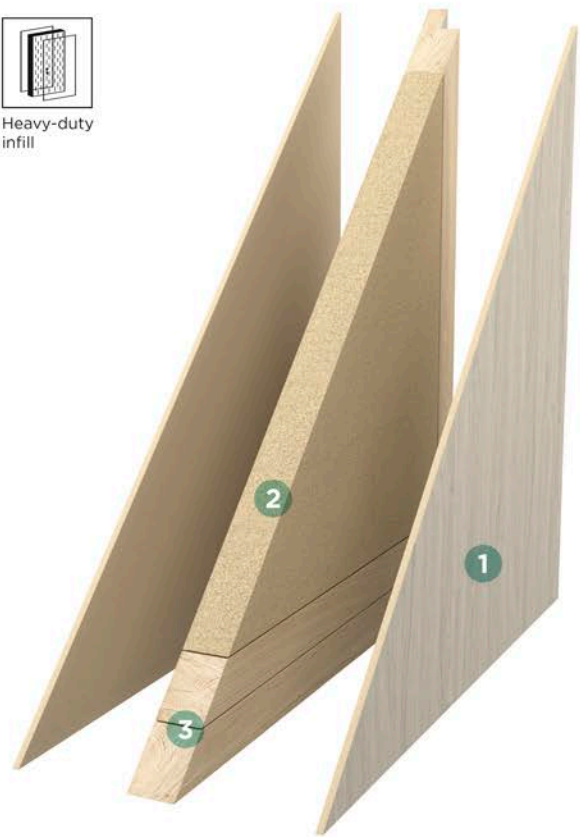

1. outer HDF lining
2. solid panel infill
3. double rail of soft wood

SYMBOLS



Tailor-made

TAILOR-MADE DOORS

Doors can be ordered in non-standard widths and heights to match your requirements. Taller door leaves can also be ordered with extra hinges and a repositioned door lock.



Frame structure

FRAME STRUCTURE

Solid structure made from engineered wood panels or timber and MDF to withstand long-term use. All parts are solid and the joints made with plugs and stabilizer tongues to provide a heavy-duty and stable construction.



MDF structure

MDF STRUCTURE

Standard stiles and rails are made from MDF. Optionally rails can be made from timber for an additional charge. This option applies to BASIC doors.



Timber structure

TIMBER STRUCTURE

A robust option available for BASIC doors. Soft wood rails and stiles enclosing a bracing infill panel with a honeycomb core. Complete with a 3 mm HDF lining.

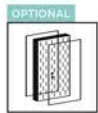

Heavy-duty infill

SOLID PANEL INFILL

A standard feature of SOLID PLUS doors. Option available for BASIC door leaves. An extra hinge is available for an additional charge for door widths of 60, 70 and 80.



Frame structure

GLAZING FRAME SYSTEM

BASIC doors feature modern glazing beading.



VSG 2.2.1 glass

VSG 2.2.1 GLASS

Smooth on both sides and with improved strength and impact resistance. Optionally available for PRESTIGE doors and a standard feature of BRILLIANT doors.



Tempered glass

TEMPERED GLASS

4 mm thick satin tempered glass, a standard feature of the PRESTIGE collection.



2 standard hinges



Modern Nickel hardware



3 standard hinges



3D hinges



3 HD hinges



Black hinges

HARDWARE

BRILLIANT and PRESTIGE standard doors feature 3 screw pivot hinges for superior stability in motion and a high load capacity. BASIC standard doors are hung on 2 hinges (90 mm door leaf width features 3 hinges). A third hinge is required for these door leaves: 110 mm wide, 60-80 mm wide with a solid panel infill, and 110-300 mm tall. The PRESTIGE Collection features nickel-plated hinges for a smart and shiny finish. The superior quality of the BRILLIANT door hinges complete the state-of-the-art design to satisfy even the highest of expectations. Heavy-duty SOLID PLUS doors feature three 3D HD hinges (which can be adjusted in three different directions).



Nickel-plated hinges available for standard BRILLIANT doors



Optional All-black hinges available for BRILLIANT doors



Optional gold hinges available for BRILLIANT doors



Nickel-plated hinges available for standard PRESTIGE doors



Zinc-coated hinges available for standard BASIC doors



3D hinges available for standard SOLID PLUS doors



60-90



100



100-200

DOOR WIDTH

Standard door widths include 60, 70, 80 and 90 mm options. Other sizes (100 and 110) are available for an additional charge, depending on the model of door. Double doors are available between 100 and 200 mm in width, with availability of the width option dependent on the door collection and model.



Rebated

REBATED DOORS

A standard feature of the BASIC, PRESTIGE and BRILLIANT Collections. The door leaf features a rebate lip which overlaps the frame upon closing. The door is covered by the rebate lip. The exposed hinges and decorative details of the doors striker a good tone in traditionally designed rooms.



Non-rebated SIMPLE

SIMPLE NON-REBATED DOORS

Available as an option with the BASIC, PRESTIGE and BRILLIANT Collections. The straight edge of the door leaf closes flush with the frame. Visually, this forms a more contemporary look, without unnecessary details, perfect for minimalist decoration.



Non-rebated sliding

SLIDING NON-REBATED DOORS

A non-rebated door leaf with plain edges and a recessed pull instead of a typical door handle. A modern and minimalist solution for a wide variety of uses.

SYMBOLS

VENTILATION

Doors fitted on rooms that require efficient air ventilation (e.g. bathrooms) should - as required by building regulations - feature suitable vents (0,022 m²). Ventilation grilles provide the required ventilation levels. There are also other solutions available allowing clearance between the door and the floor, depending on the door width, so as to provide the total required ventilation level of 0,022 m².

So as to adapt them to requirements, Vivento doors are available with a ventilation cut or vent sleeves (plastic or metal), or a door grille (stainless steel). Grilles are only available for doors at least 80cm wide in the Brilliant and Prestige Collections.

Soundproof doors feature fire rated grilles (not applicable for smoke-tight doors). See details in door model specifications. Doors fitted with grilles can be shortened up to a maximum of 30 mm.

For shorter doors built to size, the chosen type of ventilation should be checked for suitability.



Ventilation sleeves



Ventilation sleeves

VENT SLEEVES



NO. OF VENT SLEEVES PER DOOR LEAF SIZE

Door leaf width	Vent sleeves
60	4
70	4
80	4
90	5
100	5
110	5

METAL, NICKEL OR BRONZE VENT SLEEVES

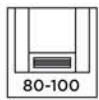

80-100
Door grille

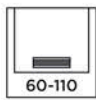

60-110
Door grille

PLASTIC DOOR GRILLE



STAINLESS STEEL DOOR GRILLE



Doors fitted with grilles can be shortened up to a maximum of 30 mm.



Ventilation cut



Ventilation cut

VENTILATION CUT

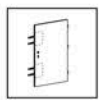

2 bolt locks

2 BOLT LOCKS

A standard feature of the SOLID PLUS heavy-duty doors. Two mortice bolts with Euro profile cylinders provide solid closure and a reassuring sense of security.

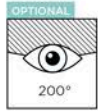

Spyhole

200° FOV SPYHOLE

An optional feature of the SOLID PLUS doors. A high-quality spyhole by Cyklop, available in a selection of colours.



Chrome



Ground stainless steel



Satin chrome



Satin nickel



Brass



Vintage brass



White



Black

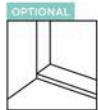

Door sills

DOOR SILLS

Doors can be ordered with a raw timber sill and a weatherstrip or a stainless steel sheet sill and a rubber weatherstrip. A door sill improves the air seal on a closed door as well as the thermal insulation and aesthetics.



Drop-down seal

DROP-DOWN SEAL

A standard feature of the Soundproof doors. Available optionally for the SOLID PLUS doors. A drop-down seal is a barrier which prevents the transfer of air, sound, dust, insects, flame or smoke. Drop-down seals improve thermal and sound insulation performance.



Soundproofing

SOUNDPROOFING

The dedicated structural design of Vivento Soundproof doors includes a carefully engineered weatherstrip system to provide excellent noise insulation of 32 dB in single doors and 27 dB in double doors.



EI30/EI60
Fire rated doors

EI30/EI60 FIRE RATED DOORS

The all-round performers: EI30 and EI60 fire rated Soundproof doors provide the required fire protection for each rating.



Door closer

DOOR CLOSER

Fire-rated doors are critical components of building safety. They must conform to certain specifications related to fire integrity and access control. A door closer is obligatory and must be compatible with the door size and weight. Homefee fire rated soundproof doors can feature surface-mounted or concealed door closers, compliant with all required certification. A door closer is a mandatory feature of every fire rated door.



BRILLIANT BC-01, CPL Uni Anthracite

INTERNAL DOORS

/ **BRILLIANT**

Contemporary design lines, superior quality of materials, extreme durability. The BRILLIANT Collection offers the ideal doors for even the most demanding users.

BRILLIANT BA-01, CPL Uni White

BRILLIANT BA /

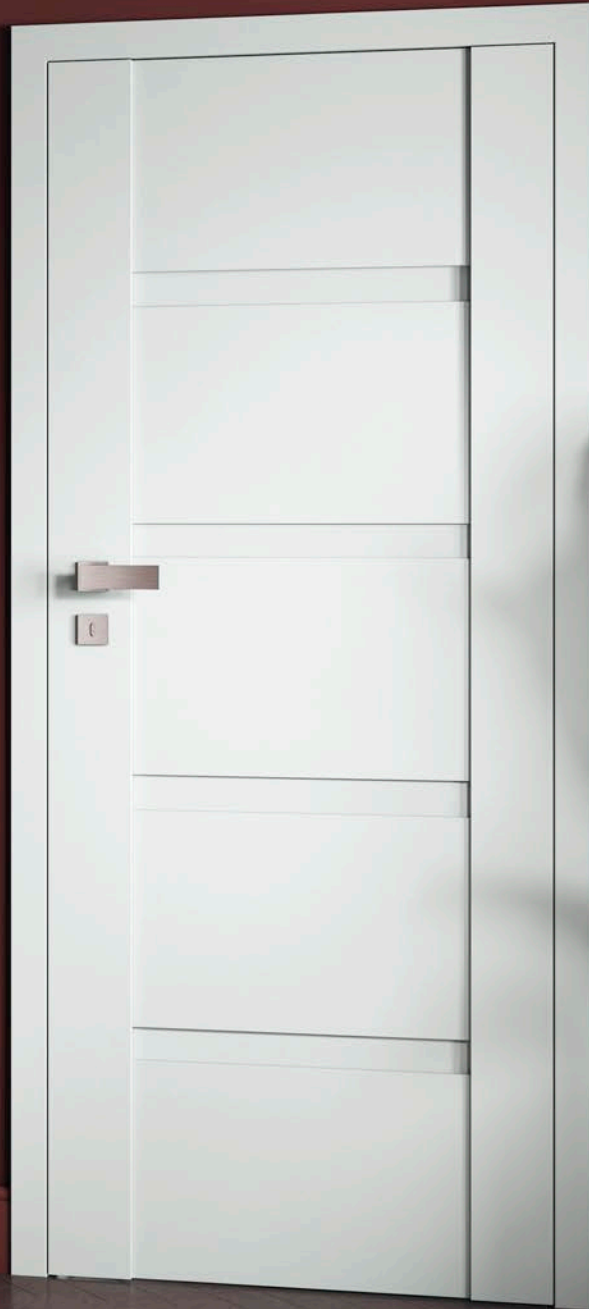

COLOUR: CPL Uni White



BA-01



BA-02



BA-03



BA-04



BA-05

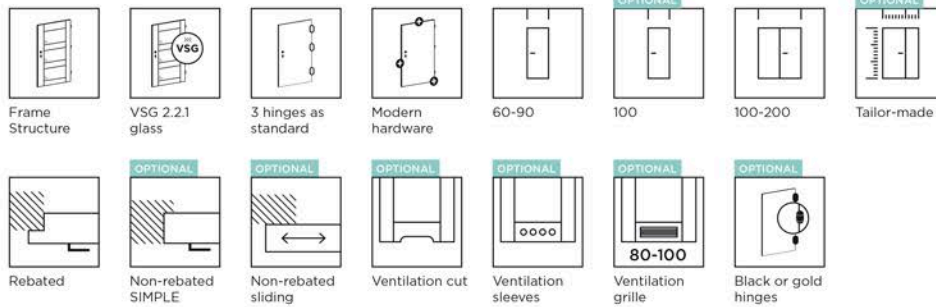

AVAILABLE WIDTH OPTIONS

- 60, 70, 80, 90, other sizes available for an additional charge

STRUCTURE

- Stable frame structure of timber and MDF

FRAME OPTIONS

- Fixed: MDF
- Adjustable: DIN (available for wall thickness min. 80 mm)

FIXTURES

- 4 mm Satin VSG 2.2.1 glass, both sides smooth
- Mortice lock, key operated (can be replaced with a lock with blocking option, a Euro profile cylinder lock, or without a keyhole)
- Nickel screw-fixing pivot hinges (colour can be changed to black or gold), 3pcs.

BRILLIANT BA PRICING

Colour group	Price
	Glass: Satin VSG 2.2.1
PP	£ 426,00
CPL	£ 406,00
CLPL	£ 399,50

Satin VSG 2.2.1 glass can be changed to black VSG 2.2.1 glass for an additional cost, priced individually.

OPTIONS FOR AN ADDITIONAL COST

NON-STANDARD WIDTH	ADDITIONAL COST
Width 100	£ 30,50
Width less than 60	£ 188,00
Non-standard width	£92,00
NON-STANDARD HEIGHT	ADDITIONAL COST
Shorter, up to 60 mm	£26,00
Shorter, more than 60 mm (requires evaluation of manufacturability)	£96,50
Taller, up to 240 mm (requires evaluation of manufacturability)	£96,50
Extra hinge (required for all door leaves 110 mm to 240 mm taller)	£10,50
Extra hinge for the SIMPLE non-rebated system (required for all door leaves 110 mm to 240 mm taller)	£ 39,50
Repositioned lock (recommended for non-standard door height)	£ 30,50
Modification of model due to non-standard door height	£ 43,50
VENTILATION	ADDITIONAL COST
Ventilation cut	£ 13,50
Metal ventilation sleeves in nickel or bronze colour (piece)	£ 13,50
Plastic door grille, matt silver, fits door leaf sizes 80, 90 and 100	£ 26,00
OTHER	ADDITIONAL COST
SIMPLE non-rebated door leaf	£ 87,00
Sliding non-rebated door leaf (not applicable for PP colour group)	£ 21,50
Double door inactive leaf, width S2 420-609 mm	£ 188,00
Double door inactive leaf, width S2 610 mm, 710 mm, 810 mm, 910 mm	£ 39,50
Double door inactive leaf, width: S2 1010 mm	£ 70,00
Drop-down seal	£ 43,00

AVAILABLE COLOURS

PP GROUP

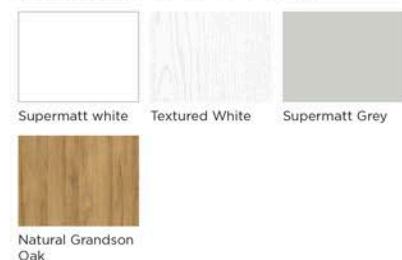

CPL GROUP

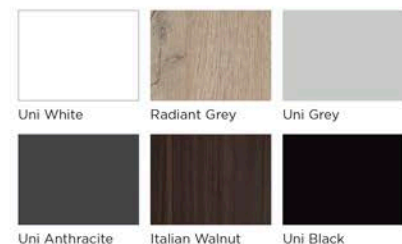

CLPL GROUP



BRILLIANT BB-02, CPL Uni Grey

BRILLIANT BB



COLOUR: CPL Uni Grey

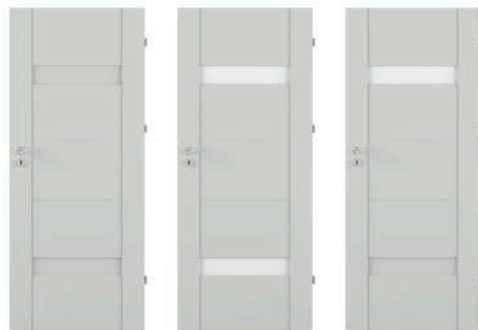

BB-01

BB-02

BB-03

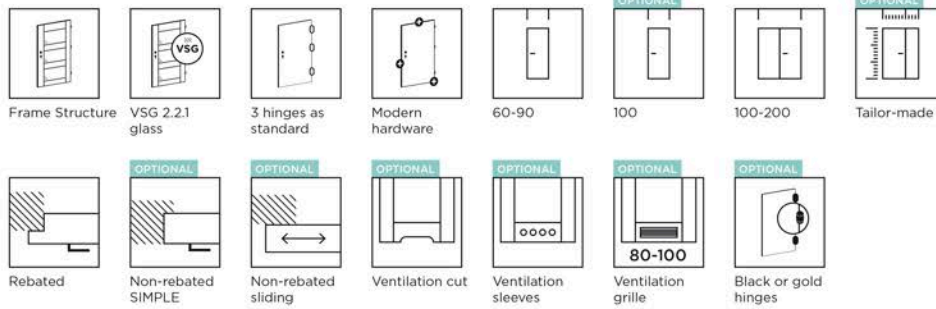

AVAILABLE WIDTH OPTIONS

- 60, 70, 80, 90, other sizes available for an additional charge

STRUCTURE

- Stable frame structure of timber and MDF

FRAME OPTIONS

- Fixed: MDF
- Adjustable: DIN (available for wall thickness min. 80 mm)

FIXTURES

- 4 mm Satin VSG 2.2.1 glass, both sides smooth
- Mortice lock, key operated (can be replaced with a lock with blocking option, a Euro profile cylinder lock, or without a keyhole)
- Nickel screw-fixing pivot hinges (colour can be changed to black or gold), 3pcs.

BRILLIANT BB PRICING

Colour group	Price
	Glass: Satin VSG 2.2.1
PP	£ 421,50
CPL	£ 406,50
CLPL	£ 399,50

OPTIONS FOR AN ADDITIONAL COST

NON-STANDARD WIDTH	ADDITIONAL COST
Width 100	£ 30,50
Width less than 60	£ 188,00
Non-standard width	£ 92,00
NON-STANDARD HEIGHT	ADDITIONAL COST
Shorter, up to 60 mm	£ 26,00
Shorter, more than 60 mm (requires evaluation of manufacturability)	£ 96,50
Taller, up to 240 mm (requires evaluation of manufacturability)	£ 96,50
Extra hinge (required for all door leaves 110 mm to 240 mm taller)	£ 10,50
Extra hinge for the SIMPLE non-rebated system (required for all door leaves 110 mm to 240 mm taller)	£ 39,50
Repositioned lock (recommended for non-standard door height)	£ 30,50
Modification of model due to non-standard door height	£ 43,50
VENTILATION	ADDITIONAL COST
Ventilation cut	£ 13,50
Metal ventilation sleeves in nickel or bronze colour (piece)	£ 13,50
Plastic door grille, matt silver, fits door leaf sizes 80, 90 and 100	£ 26,00
OTHER	ADDITIONAL COST
SIMPLE non-rebated door leaf	£ 87,00
Sliding non-rebated door leaf (not applicable for PP colour group)	£ 21,50
Double door inactive leaf, width S2 420-609 mm	£ 188,00
Double door inactive leaf, width S2 610 mm, 710 mm, 810 mm, 910 mm	£ 39,50
Double door inactive leaf, width: S2 1010 mm	£ 70,00
Drop-down seal	£ 43,00

AVAILABLE COLOURS

PP GROUP

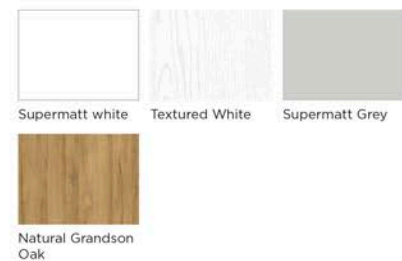

CPL GROUP

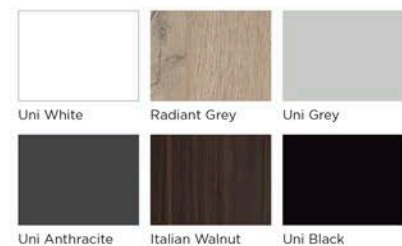

CLPL GROUP



BRILLIANT BC-01, CPL Uni Anthracite

BRILLIANT BC /

COLOUR: CPL Uni Anthracite



BC-01



BC-02



BC-03

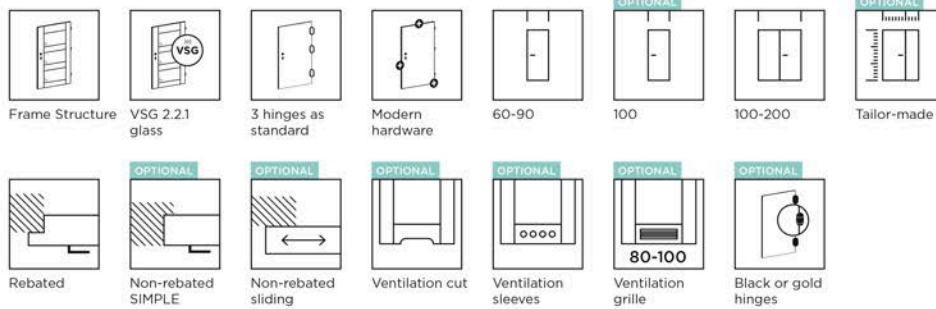

AVAILABLE WIDTH OPTIONS

- 60, 70, 80, 90, other sizes available for an additional charge

STRUCTURE

- Stable frame structure of timber and MDF

FRAME OPTIONS

- Fixed: MDF
- Adjustable: DIN (available for wall thickness min. 80 mm)

FIXTURES

- 4 mm Satin VSG 2.2.1 glass, both sides smooth
- Mortice lock, key operated (can be replaced with a lock with blocking option, a Euro profile cylinder lock, or without a keyhole)
- Nickel screw-fixing pivot hinges (colour can be changed to black or gold), 3pcs.

BRILLIANT BC PRICING

Colour group	Price
	Glass: Satin VSG 2.2.1
PP	£ 417,00
CPL	£ 404,00
CLPL	£ 399,50

OPTIONS FOR AN ADDITIONAL COST

NON-STANDARD WIDTH	ADDITIONAL COST
Width 100	£ 30,50
Width less than 60	£ 188,00
Non-standard width	£ 92,00
NON-STANDARD HEIGHT	ADDITIONAL COST
Shorter, up to 60 mm	£ 26,00
Shorter, more than 60 mm (requires evaluation of manufacturability)	£ 96,50
Taller, up to 240 mm (requires evaluation of manufacturability)	£ 96,50
Extra hinge (required for all door leaves 110 mm to 240 mm taller)	£ 10,50
Extra hinge for the SIMPLE non-rebated system (required for all door leaves 110 mm to 240 mm taller)	£ 39,50
Repositioned lock (recommended for non-standard door height)	£ 30,50
Modification of model due to non-standard door height	£ 43,50
VENTILATION	ADDITIONAL COST
Ventilation cut	£ 13,50
Metal ventilation sleeves in nickel or bronze colour (piece)	£ 13,50
Plastic door grille, matt silver, fits door leaf sizes 80, 90 and 100	£ 26,00
OTHER	ADDITIONAL COST
SIMPLE non-rebated door leaf	£ 87,00
Sliding non-rebated door leaf (not applicable for PP colour group)	£ 21,50
Double door inactive leaf, width S2 420-609 mm	£ 188,00
Double door inactive leaf, width S2 610 mm, 710 mm, 810 mm, 910 mm	£ 39,50
Double door inactive leaf, width: S2 1010 mm	£ 70,00
Drop-down seal	£ 43,00

AVAILABLE COLOURS

PP GROUP

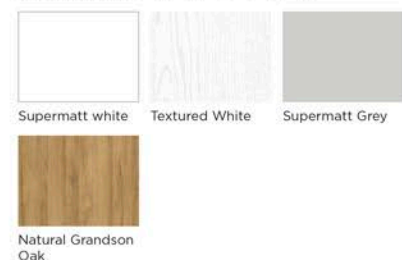

CPL GROUP

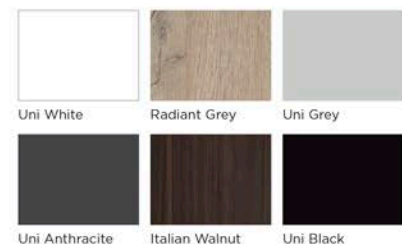

CLPL GROUP





BRILLIANT
BD /

COLOUR: CPL Radiant Grey



BD-01

BD-02

BD-03

BD-04

BD-05

BD-06

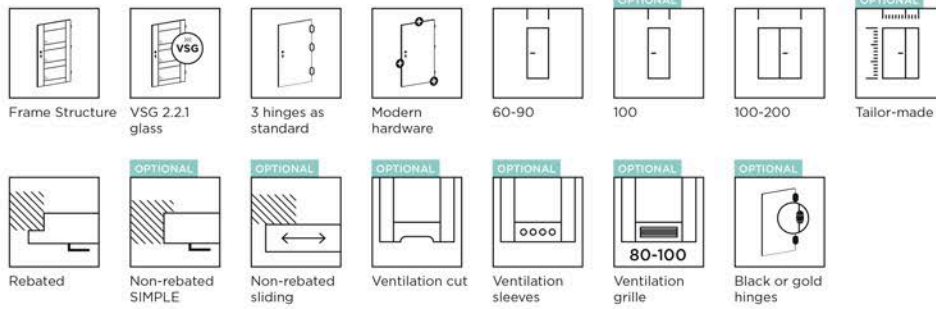

AVAILABLE WIDTH OPTIONS

- 60, 70, 80, 90, other sizes available for an additional charge

STRUCTURE

- Stable frame structure of timber and MDF

FRAME OPTIONS

- Fixed: MDF
- Adjustable: DIN (available for wall thickness min. 80 mm)

FIXTURES

- 4 mm Satin VSG 2.2.1 glass, both sides smooth
- Mortice lock, key operated (can be replaced with a lock with blocking option, a Euro profile cylinder lock, or without a keyhole)
- Nickel screw-fixing pivot hinges (colour can be changed to black or gold), 3pcs.

BRILLIANT BD PRICING

Colour group	Price
	Glass: Satin VSG 2.2.1
PP	£ 430,50
CPL	£ 417,00
CLPL	£ 412,50

OPTIONS FOR AN ADDITIONAL COST

NON-STANDARD WIDTH

	ADDITIONAL COST
Width 100	£ 30,50
Width less than 60	£ 188,00
Non-standard width	£ 92,00

NON-STANDARD HEIGHT

	ADDITIONAL COST
Shorter, up to 60 mm	£ 26,00
Shorter, more than 60 mm (requires evaluation of manufacturability)	£ 96,50
Taller, up to 240 mm (requires evaluation of manufacturability)	£ 96,50
Extra hinge (required for all door leaves 110 mm to 240 mm taller)	£ 10,50
Extra hinge for the SIMPLE non-rebated system (required for all door leaves 110 mm to 240 mm taller)	£ 39,50
Repositioned lock (recommended for non-standard door height)	£ 30,50
Modification of model due to non-standard door height	£ 43,50

VENTILATION

	ADDITIONAL COST
Ventilation cut	£ 13,50
Metal ventilation sleeves in nickel or bronze colour (piece)	£ 13,50
Plastic door grille, matt silver, fits door leaf sizes 80, 90 and 100	£ 36,00

OTHER

	ADDITIONAL COST
SIMPLE non-rebated door leaf	£ 87,00
Sliding non-rebated door leaf (not applicable for PP colour group)	£ 21,50
Double door inactive leaf, width S2 420-609 mm	£ 188,00
Double door inactive leaf, width S2 610 mm, 710 mm, 810 mm, 910 mm	£ 39,50
Double door inactive leaf, width: S2 1010 mm	£ 70,00
Drop-down seal	£ 43,00

AVAILABLE COLOURS

PP GROUP

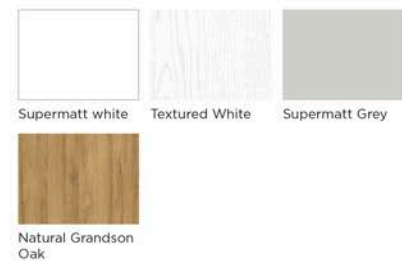

CPL GROUP

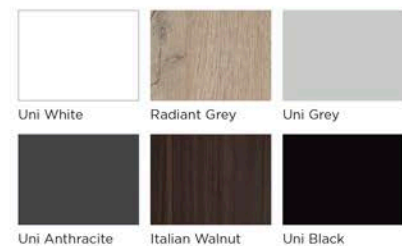

CLPL GROUP





BRILLIANT
BE /

COLOUR: PP Supermatt Grey



BE-01

BE-02

BE-03

BE-04

BE-05

BE-06

BE-07

BE-08

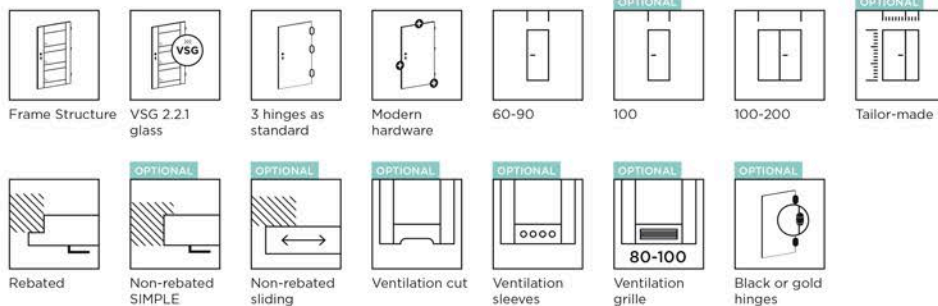

AVAILABLE WIDTH OPTIONS

- 60, 70, 80, 90, other sizes available for an additional charge

STRUCTURE

- Stable frame structure of timber and MDF

FRAME OPTIONS

- Fixed: MDF
- Adjustable: DIN (available for wall thickness min. 80 mm)

FIXTURES

- 4 mm Satin VSG 2.2.1 glass, both sides smooth
- Mortice lock, key operated (can be replaced with a lock with blocking option, a Euro profile cylinder lock, or without a keyhole)
- Nickel screw-fixing pivot hinges (colour can be changed to black or gold), 3pcs.

BRILLIANT BE PRICING

Colour group	Price
	Glass: Satin VSG 2.2.1
PP	£ 417,50
CPL	£ 404,00
CLPL	£ 395,00

OPTIONS FOR AN ADDITIONAL COST

NON-STANDARD WIDTH	ADDITIONAL COST
Width 100	£ 30,50
Width less than 60	£ 188,00
Non-standard width	£ 92,00
NON-STANDARD HEIGHT	ADDITIONAL COST
Shorter, up to 60 mm	£ 26,00
Shorter, more than 60 mm (requires evaluation of manufacturability)	£ 96,50
Taller, up to 240 mm (requires evaluation of manufacturability)	£ 96,50
Extra hinge (required for all door leaves 110 mm to 240 mm taller)	£ 10,50
Extra hinge for the SIMPLE non-rebated system (required for all door leaves 110 mm to 240 mm taller)	£ 39,50
Repositioned lock (recommended for non-standard door height)	£ 30,50
Modification of model due to non-standard door height	£ 43,50
VENTILATION	ADDITIONAL COST
Ventilation cut	£ 13,50
Metal ventilation sleeves in nickel or bronze colour (piece)	£ 13,50
Plastic door grille, matt silver, fits door leaf sizes 80, 90 and 100	£ 26,00
OTHER	ADDITIONAL COST
SIMPLE non-rebated door leaf	£ 87,00
Sliding non-rebated door leaf (not applicable for PP colour group)	£ 21,50
Double door inactive leaf, width S2 420-609 mm	£ 188,00
Double door inactive leaf, width S2 610 mm, 710 mm, 810 mm, 910 mm	£ 39,50
Double door inactive leaf, width: S2 1010 mm	£ 70,00
Drop-down seal	£ 43,00

AVAILABLE COLOURS

PP GROUP

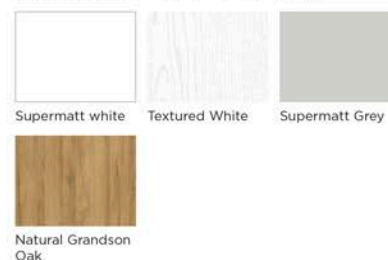

CPL GROUP

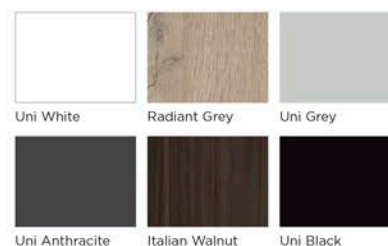

CLPL GROUP



BRILLIANT BF-04, PP Textured White

BRILLIANT BF /



COLOUR: PP Textured White



BF-01

BF-02

BF-03

BF-04

BF-05

BF-06

BF-07

BF-08

BF-09

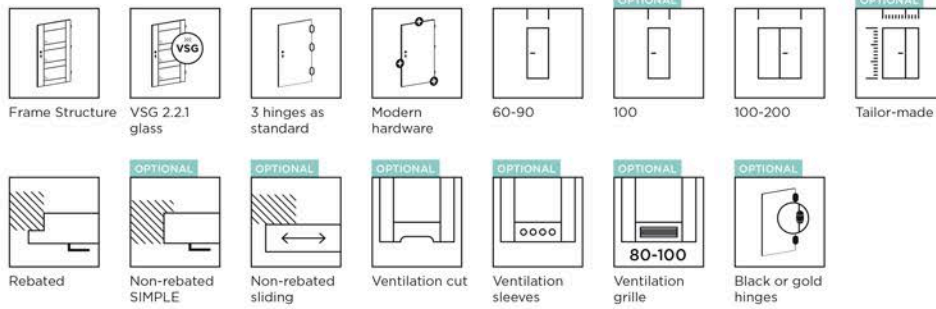

AVAILABLE WIDTH OPTIONS

- 60, 70, 80, 90, other sizes available for an additional charge

STRUCTURE

- Stable frame structure of timber and MDF

FRAME OPTIONS

- Fixed: MDF
- Adjustable: DIN (available for wall thickness min. 80 mm)

FIXTURES

- 4 mm Satin VSG 2.2.1 glass, both sides smooth
- Mortice lock, key operated (can be replaced with a lock with blocking option, a Euro profile cylinder lock, or without a keyhole)
- Nickel screw-fixing pivot hinges (colour can be changed to black or gold), 3pcs.

BRILLIANT BF PRICING

Colour group	Price
	Glass: Satin VSG 2.2.1
PP	£ 417,50
CPL	£ 404,00
CLPL	£ 395,00

Satin VSG 2.2.1 glass can be changed to black VSG 2.2.1 glass for an additional cost, priced individually.

OPTIONS FOR AN ADDITIONAL COST

NON-STANDARD WIDTH	ADDITIONAL COST
Width 100	£ 30,50
Width less than 60	£ 188,00
Non-standard width	£ 92,00
NON-STANDARD HEIGHT	ADDITIONAL COST
Shorter, up to 60 mm	£ 26,00
Shorter, more than 60 mm (requires evaluation of manufacturability)	£ 96,50
Taller, up to 240 mm (requires evaluation of manufacturability)	£ 96,50
Extra hinge (required for all door leaves 110 mm to 240 mm taller)	£ 10,50
Extra hinge for the SIMPLE non-rebated system (required for all door leaves 110 mm to 240 mm taller)	£ 39,50
Repositioned lock (recommended for non-standard door height)	£ 30,50
Modification of model due to non-standard door height	£ 43,50
VENTILATION	ADDITIONAL COST
Ventilation cut	£ 13,50
Metal ventilation sleeves in nickel or bronze colour (piece)	£ 13,50
Plastic door grille, matt silver, fits door leaf sizes 80, 90 and 100	£ 26,00
OTHER	ADDITIONAL COST
SIMPLE non-rebated door leaf	£ 87,00
Sliding non-rebated door leaf (not applicable for PP colour group)	£ 21,50
Double door inactive leaf, width S2 420-609 mm	£ 188,00
Double door inactive leaf, width S2 610 mm, 710 mm, 810 mm, 910 mm	£ 39,50
Double door inactive leaf, width: S2 1010 mm	£ 70,00
Drop-down seal	£ 43,00

AVAILABLE COLOURS

PP GROUP

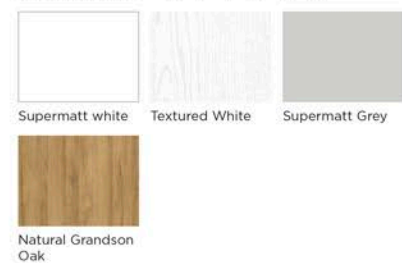

CPL GROUP

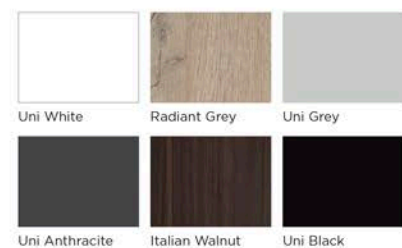

CLPL GROUP



BRILLIANT BG-01, PP Natural Grandson Oak

BRILLIANT BG /



COLOUR: PP Natural Grandson Oak



BG-01



BG-02



BG-03



BG-04



BG-05



BG-06

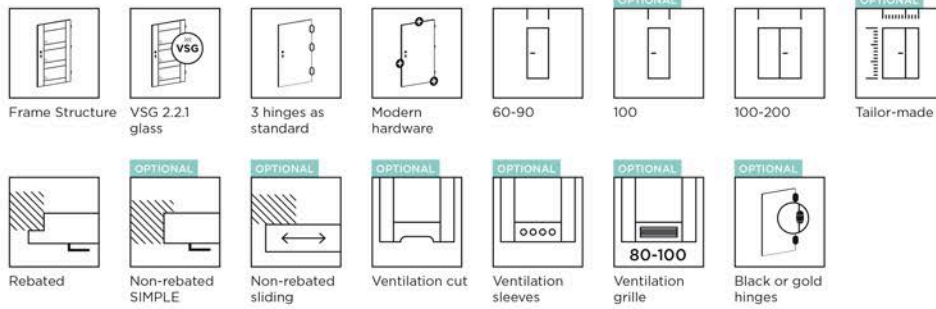

AVAILABLE WIDTH OPTIONS

- 60, 70, 80, 90, other sizes available for an additional charge

STRUCTURE

- Stable frame structure of timber and MDF

FRAME OPTIONS

- Fixed: MDF
- Adjustable: DIN (available for wall thickness min. 80 mm)

FIXTURES

- 4 mm Satin VSG 2.2.1 glass, both sides smooth
- Mortice lock, key operated (can be replaced with a lock with blocking option, a Euro profile cylinder lock, or without a keyhole)
- Nickel screw-fixing pivot hinges (colour can be changed to black or gold), 3pcs.

BRILLIANT BG PRICING

Colour group	Price
	Glass: Satin VSG 2.2.1
PP	£ 426,00
CPL	£ 408,50
CLPL	£ 399,50

Satin VSG 2.2.1 glass can be changed to black VSG 2.2.1 glass for an additional cost, priced individually.

OPTIONS FOR AN ADDITIONAL COST

NON-STANDARD WIDTH	ADDITIONAL COST
Width 100	£ 30,50
Width less than 60	£ 188,00
Non-standard width	£ 92,00

NON-STANDARD HEIGHT	ADDITIONAL COST
Shorter, up to 60 mm	£ 26,00
Shorter, more than 60 mm (requires evaluation of manufacturability)	£ 96,50
Taller, up to 240 mm (requires evaluation of manufacturability)	£ 96,50
Extra hinge (required for all door leaves 110 mm to 240 mm taller)	£ 10,50
Extra hinge for the SIMPLE non-rebated system (required for all door leaves 110 mm to 240 mm taller)	£ 39,50
Repositioned lock (recommended for non-standard door height)	£ 30,50
Modification of model due to non-standard door height	£ 43,50

VENTILATION	ADDITIONAL COST
Ventilation cut	£ 13,50
Metal ventilation sleeves in nickel or bronze colour (piece)	£ 13,50
Plastic door grille, matt silver, fits door leaf sizes 80, 90 and 100	£ 26,00

OTHER	ADDITIONAL COST
SIMPLE non-rebated door leaf	£ 87,00
Sliding non-rebated door leaf (not applicable for PP colour group)	£ 21,50
Double door inactive leaf, width S2 420-609 mm	£ 188,00
Double door inactive leaf, width S2 610 mm, 710 mm, 810 mm, 910 mm	£ 39,50
Double door inactive leaf, width: S2 1010 mm	£ 70,00
Drop-down seal	£ 43,00

AVAILABLE COLOURS

PP GROUP

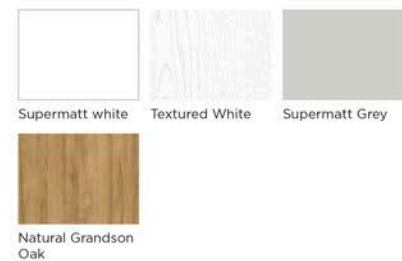

CPL GROUP

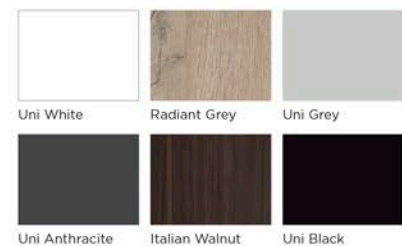

CLPL GROUP





BRILLIANT BO-01, CPL Uni White

BRILLIANT
BO

COLOUR: CPL Uni White



BO-01



BO-02

Bevelled Satin VSG 2.2.1 glass
(bevelled satin, opaque)



BO-03

opaque VSG 2.2.1 bevelled glass



BO-02 model bevel and satin opaque glass



BO-03 model bevel and opaque glass

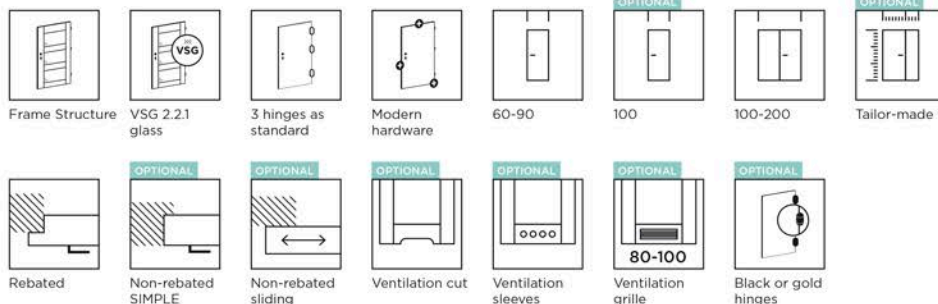

AVAILABLE WIDTH OPTIONS

- 60, 70, 80, 90, other sizes available for an additional charge

STRUCTURE

- Stable frame structure of timber and MDF

FRAME OPTIONS

- Fixed: MDF
- Adjustable: DIN (available for wall thickness min. 80 mm)

FIXTURES

- 4 mm Satin VSG 2.2.1 glass, both sides smooth
- Optional: 4mm Satin VSG 2.2.1 glass, both sides smooth (non bevelled)
- Mortice lock, key operated (can be replaced with a lock with blocking option, a Euro profile cylinder lock, or without a keyhole)
- Nickel screw-fixing pivot hinges (colour can be changed to black), 3pcs

BRILLIANT BO PRICING

Colour group	Price	
	Type BO-01	Type BO-02 & BO-03 Glass: Satin or clear VSG 2.2.1 glass
PP	£ 417,50	£ 527,00
CPL	£ 404,00	£ 522,50
CLPL	£ 395,50	£ 513,50

OPTIONS FOR AN ADDITIONAL COST

NON-STANDARD WIDTH	ADDITIONAL COST
Width 100	£ 30,50
Width less than 60	£ 188,00
Non-standard width	£ 92,00
NON-STANDARD HEIGHT	ADDITIONAL COST
Shorter, up to 60 mm	£ 26,00
Shorter, more than 60 mm (requires evaluation of manufacturability)	£ 96,50
Taller, up to 240 mm (requires evaluation of manufacturability)	£ 96,50
Extra hinge (required for all door leaves 110 mm to 240 mm taller)	£ 10,50
Extra hinge for the SIMPLE non-rebated system (required for all door leaves 110 mm to 240 mm taller)	£ 39,50
Repositioned lock (recommended for non-standard door height)	£ 30,50
Modification of model due to non-standard door height	£ 43,50
VENTILATION	ADDITIONAL COST
Ventilation cut	£ 13,50
Metal ventilation sleeves in nickel or bronze colour (piece)	£ 13,50
Plastic door grille, matt silver, fits door leaf sizes 80, 90 and 100	£ 26,00
OTHER	ADDITIONAL COST
SIMPLE non-rebated door leaf	£ 87,00
Sliding non-rebated door leaf (not applicable for PP colour group)	£ 21,50
Double door inactive leaf, width S2 420-609 mm	£ 188,00
Double door inactive leaf, width S2 610 mm, 710 mm, 810 mm, 910 mm	£ 39,50
Double door inactive leaf, width: S2 1010 mm	£ 70,00
Drop-down seal	£ 43,00

AVAILABLE COLOURS

PP GROUP

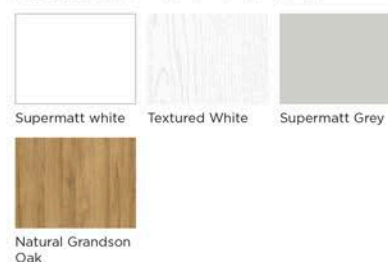

CPL GROUP

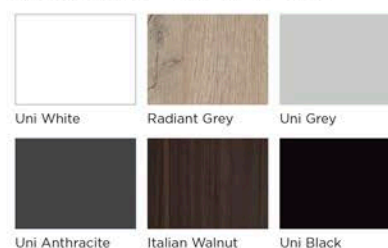

CLPL GROUP

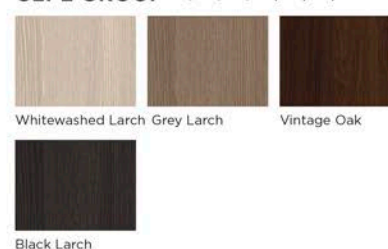



PRESTIGE PB-02, CPL Uni White

INTERNAL DOORS

／ **PRESTIGE**

An subtle addition to an interior, or a bold statement? PRESTIGE doors merge refinement and attractive design. These doors ensure privacy, whilst adding unique character to the interior your home.



COLOUR: CLPL Acacia



PA-01

PA-02

PA-03

PA-04

PA-05

PA-06

PA-07

PA-08

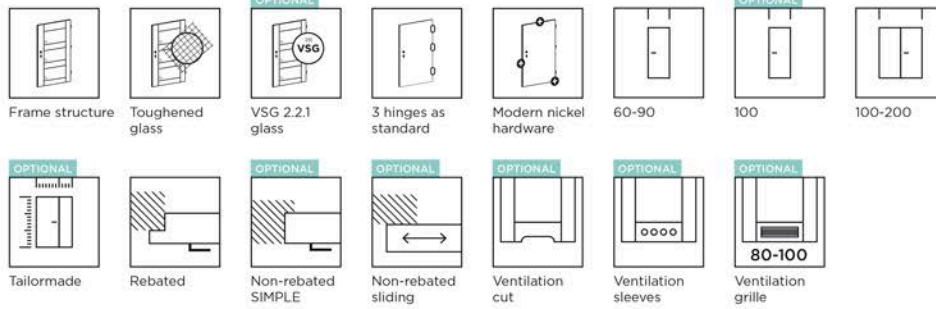

AVAILABLE WIDTH OPTIONS

- 60, 70, 80, 90, other sizes available for an additional charge

STRUCTURE

- Stable frame structure of MDF

FRAME VERSIONS

- Fixed: timber & MDF
- Adjustable: DIN, DUALE, ZOS, timber, exclusive

FITTINGS

- Satin tempered glass, thickness: 4 mm
- Optional: Satin VSG 2.2.1 glass, both sides smooth
- Mortice lock, key operated (can be replaced with a lock with blocking option, a Euro profile cylinder lock, or without a keyhole)
- Screw-fixing pivot hinges, 3pcs

PRESTIGE PA PRICING

Colour group	Price	
	Glass: Tempered satin	Glass: Satin VSG 2.2.1
CPL	£ 289,50	Ref. pricing to the left + additional cost in the table below
CLPL	£ 276,50	
FF	£ 235,00	

ALTERNATIVE GLAZING PRICES - SATIN VSG 2.2.1 GLASS

PA-01	PA-02	PA-03	PA-04	PA-05	PA-06	PA-07	PA-08
-	£ 98,50	£ 42,00	£ 56,00	£ 70,00	£ 42,00	£ 28,00	£ 56,00

OPTIONS FOR AN ADDITIONAL CHARGE

NON-STANDARD WIDTH	ADDITIONAL COST
Width 100	£ 30,50
Width less than 60	£ 188,00
Non-standard width, door leaf with Satin deco, Lacomat or Satin VSG 2.2.1 glass	£ 92,00
NON-STANDARD HEIGHT	ADDITIONAL COST
Shorter, up to 60 mm	£ 26,00
Shorter, more than 60 mm (requires evaluation of manufacturability) door leaf with Satin deco, Lacomat or Satin VSG 2.2.1 glass	£ 96,50
Taller, up to 470 mm (requires evaluation of manufacturability) door leaf with Satin deco, Lacomat or Satin VSG 2.2.1 glass	£ 96,50
Extra hinge (required for all door leaves 110 mm to 470 mm taller)	£ 10,50
Extra hinge for the SIMPLE non-rebated system (required for all door leaves 110 mm to 470 mm taller)	£ 39,50
Repositioned lock (recommended for non-standard door height)	£ 30,50
Modification of model due to non-standard door height	£ 43,50
VENTILATION	ADDITIONAL COST
Ventilation cut	£ 13,50
Metal ventilation sleeves in nickel or bronze colour (piece)	£ 13,50
Plastic door grille, matt silver, fits door leaf sizes 80, 90 and 100	£ 26,00
OTHER	ADDITIONAL COST
SIMPLE non-rebated door leaf	£ 87,00
Sliding non-rebated door leaf (not applicable for PP colour group)	£ 21,50
Double door inactive leaf, width S2 420-609 mm	£ 188,00
Double door inactive leaf, width S2 610 mm, 710 mm, 810 mm, 910 mm	£ 39,50
Double door inactive leaf, width: S2 1010 mm	£ 70,00
Drop-down seal	£ 43,00

AVAILABLE COLOURS:

CPL GROUP      

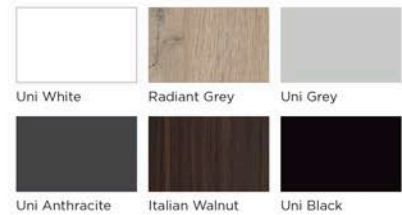

CLPL GROUP      

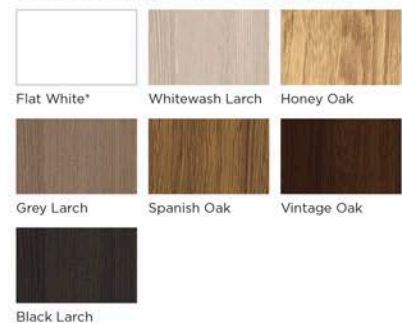

FF GROUP      

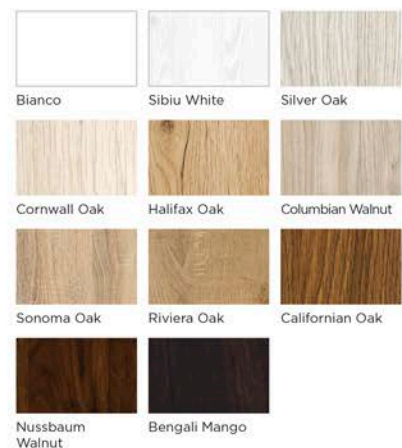

* While stocks last

NEW ARRIVAL

PRESTIGE AN-02, FF Bianco

PRESTIGE AN /

COLOUR: FF Columbian Oak

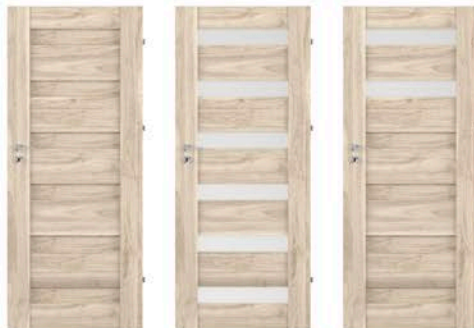

AN-01

AN-02

AN-03

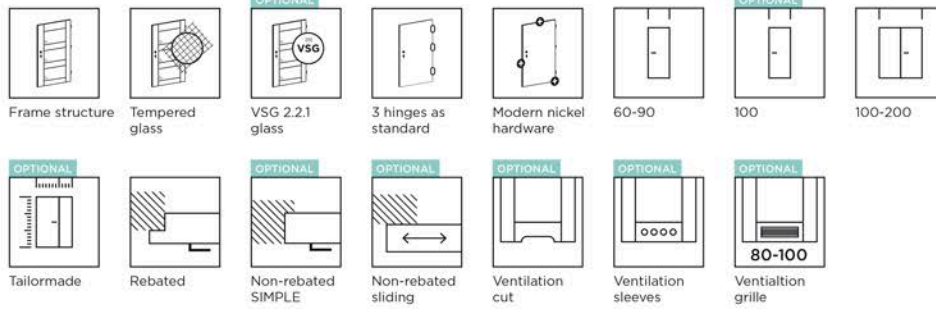

AVAILABLE WIDTH OPTIONS

- 60, 70, 80, 90, other sizes available for an additional charge

STRUCTURE

- Stable frame structure of MDF

FRAME VERSIONS

- Fixed: timber & MDF
- Adjustable: DIN, DUALE, ZOS

FITTINGS

- Satin tempered glass, thickness: 4 mm
- Optional: Satin VSG 2.2.1 glass, both sides smooth
- Mortice lock, key operated (can be replaced with a lock with blocking option, a Euro profile cylinder lock, or without a keyhole)
- Screw-fixing pivot hinges, 3pcs

PRESTIGE AN PRICING

Colour group	Price	
	Glass: Tempered satin	Glass: Satin VSG 2.2.1
CPL	£ 298,50	Ref. pricing to the left + additional cost in the table below
CLPL	£ 289,50	
FF	£ 241,50	

ALTERNATIVE GLAZING PRICES - SATIN VSG 2.2.1 GLASS

AN-01	AN-02	AN-03
-	£ 63,00	£ 21,00

OPTIONS FOR AN ADDITIONAL CHARGE

NON-STANDARD WIDTH	ADDITIONAL COST
Width 100	£ 30,50
Width less than 60	£ 188,00
Non-standard width, door leaf with Satin deco, Lacomat or Satin VSG 2.2.1 glass	£ 92,00
NON-STANDARD HEIGHT	ADDITIONAL COST
Shorter, up to 60 mm	£ 26,00
Shorter, more than 60 mm (requires evaluation of manufacturability) door leaf with Satin deco, Lacomat or Satin VSG 2.2.1 glass	£ 96,50
Taller, up to 470 mm (requires evaluation of manufacturability) door leaf with Satin deco, Lacomat or Satin VSG 2.2.1 glass	£ 96,50
Extra hinge (required for all door leaves 110 mm to 470 mm taller)	£ 10,50
Extra hinge for the SIMPLE non-rebated system (required for all door leaves 110 mm to 470 mm taller)	£ 39,50
Repositioned lock (recommended for non-standard door height)	£ 30,50
Modification of model due to non-standard door height	£ 43,50
VENTILATION	ADDITIONAL COST
ventilation cut	£ 13,50
Metal ventilation sleeves in nickel or bronze colour (piece)	£ 13,50
Plastic door grille, matt silver, fits door leaf sizes 80, 90 and 100	£ 26,00
OTHER	ADDITIONAL COST
SIMPLE non-rebated door leaf	£ 87,00
Sliding non-rebated door leaf (not applicable for PP colour group)	£ 21,50
Double door inactive leaf, width S2 420-609 mm	£ 188,00
Double door inactive leaf, width S2 610 mm, 710 mm, 810 mm, 910 mm	£ 39,50
Double door inactive leaf, width: S2 1010 mm	£ 70,00
Drop-down seal	£ 43,00

AVAILABLE COLOURS:

CPL GROUP

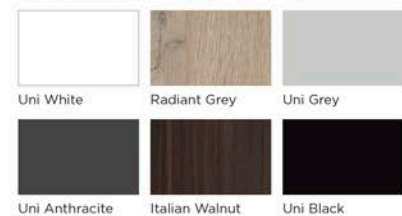

CLPL GROUP

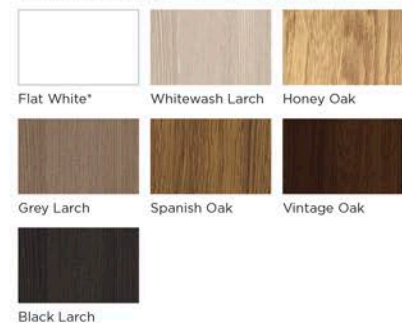

FF GROUP

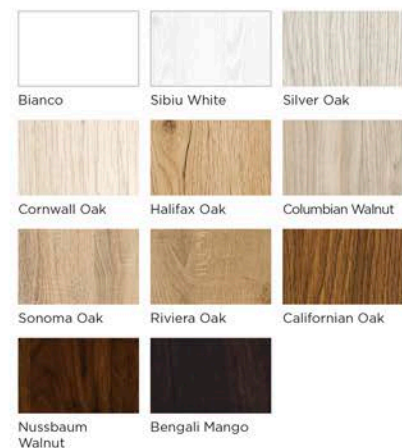

* While stocks last

PRESTIGE PB-02, CPL Uni White

PRESTIGE PB /

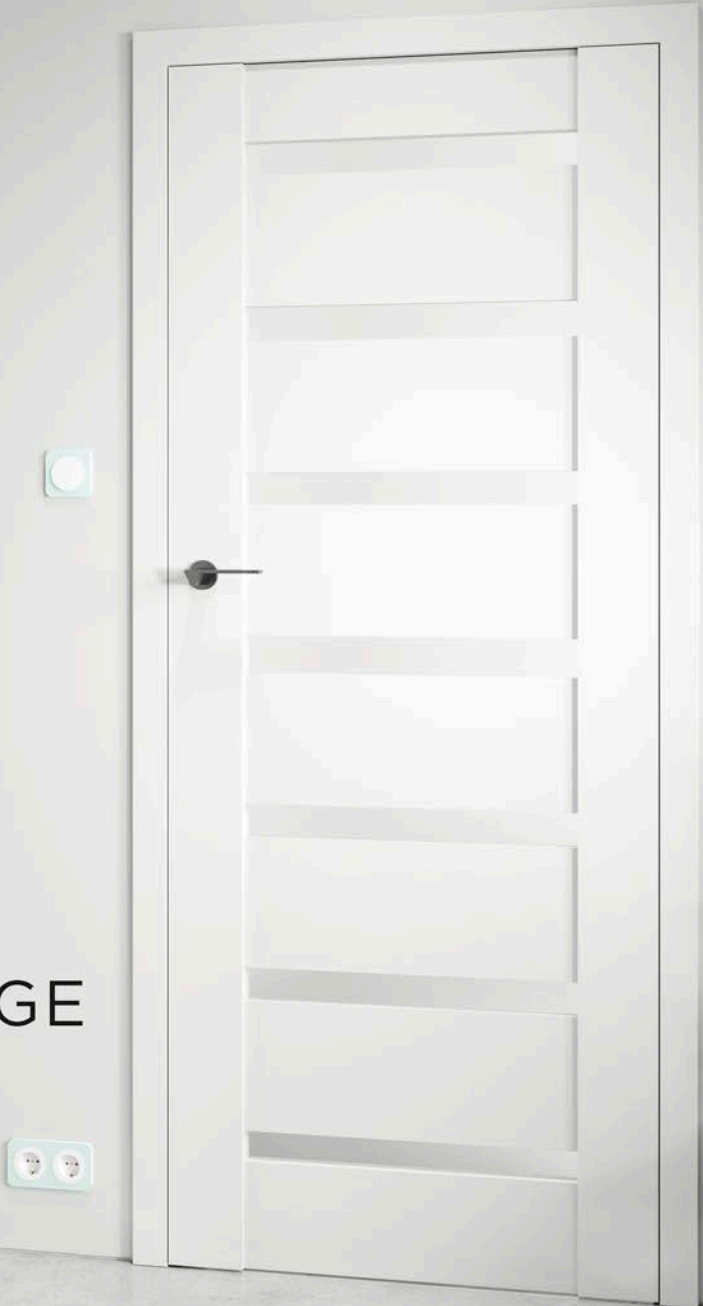

COLOUR: FF Nussbaum Oak



PB-01



PB-02



PB-03



PB-04



PB-05



PB-06

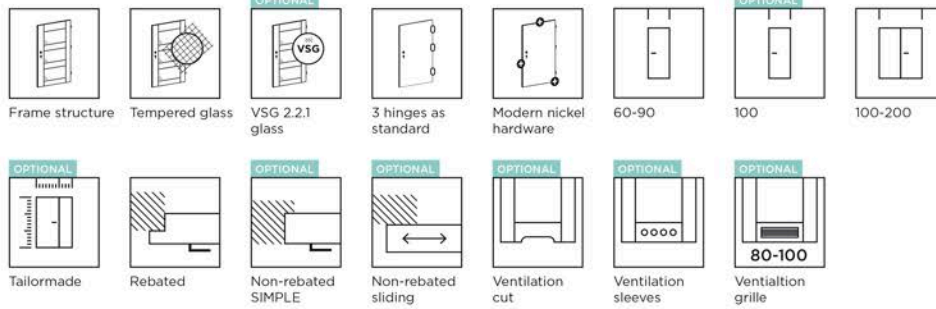

AVAILABLE WIDTH OPTIONS

- 60, 70, 80, 90, other sizes available for an additional charge

STRUCTURE

- Stable frame structure of MDF

FRAME VERSIONS

- Fixed: timber & MDF
- Adjustable: DIN, DUALE, ZOS

FITTINGS

- Satin tempered glass, thickness: 4 mm
- Optional: Satin VSG 2.2.1 glass, both sides smooth
- Mortice lock, key operated (can be replaced with a lock with blocking option, a Euro profile cylinder lock, or without a keyhole)
- Screw-fixing pivot hinges, 3pcs

PRESTIGE PB PRICING

Colour group	Price	
	Glass: Tempered satin	Glass: Satin VSG 2.2.1
CPL	£ 316,00	Ref. pricing to the left + additional cost in the table below
CLPL	£ 303,00	
FF	£ 246,00	

ALTERNATIVE GLAZING PRICES - SATIN VSG 2.2.1 GLASS

PB-01	PB-02	PB-03	PB-04	PB-05	PB-06
-	£ 55,00	£ 23,50	£ 31,50	£ 39,50	£ 23,50

OPTIONS FOR AN ADDITIONAL CHARGE

NON-STANDARD WIDTH	ADDITIONAL COST
Width 100	£ 30,50
Width less than 60	£ 188,00
Non-standard width, door leaf with Satin deco, Lacomat or Satin VSG 2.2.1 glass	£ 92,00
NON-STANDARD HEIGHT	ADDITIONAL COST
Shorter, up to 60 mm	£ 26,00
Shorter, more than 60 mm (requires evaluation of manufacturability) door leaf with Satin deco, Lacomat or Satin VSG 2.2.1 glass	£ 96,50
Taller, up to 470 mm (requires evaluation of manufacturability) door leaf with Satin deco, Lacomat or Satin VSG 2.2.1 glass	£ 96,50
Extra hinge (required for all door leaves 110 mm to 470 mm taller)	£ 10,50
Extra hinge for the SIMPLE non-rebated system (required for all door leaves 110 mm to 470 mm taller)	£ 39,50
Repositioned lock (recommended for non-standard door height)	£ 30,50
Modification of model due to non-standard door height	£ 43,50
VENTILATION	ADDITIONAL COST
Ventilation cut	£ 13,50
Metal ventilation sleeves in nickel or bronze colour (piece)	£ 13,50
Plastic door grille, matt silver, fits door leaf sizes 80, 90 and 100	£ 26,00
OTHER	ADDITIONAL COST
SIMPLE non-rebated door leaf	£ 87,00
Sliding non-rebated door leaf (not applicable for PP colour group)	£ 21,50
Double door inactive leaf, width S2 420-609 mm	£ 188,00
Double door inactive leaf, width S2 610 mm, 710 mm, 810 mm, 910 mm	£ 39,50
Double door inactive leaf, width: S2 1010 mm	£ 70,00
Drop-down seal	£ 43,00

AVAILABLE COLOURS:

CPL GROUP

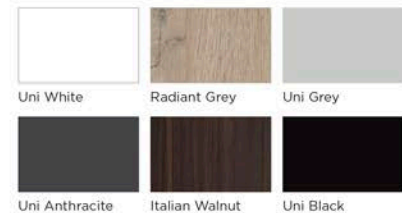

CLPL GROUP

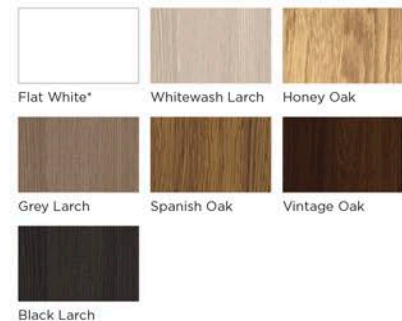

FF GROUP

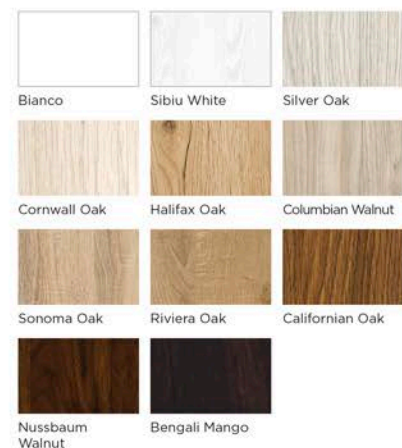

* While stocks last

PRESTIGE PC-02, FF Nussbaum Walnut

PRESTIGE PC



COLOUR: FF Sonoma Oak



PC-01



PC-02



PC-03



PC-04



PC-05



PC-06

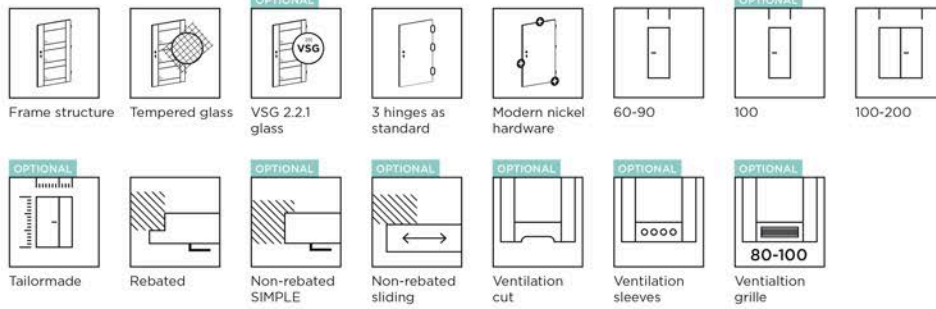

AVAILABLE WIDTH OPTIONS

- 60, 70, 80, 90, other sizes available for an additional charge

STRUCTURE

- Stable frame structure of MDF

FRAME VERSIONS

- fixed: timber & MDF
- adjustable: DIN, DUALE, ZOS

FITTINGS

- Satin tempered glass, thickness: 4 mm
- Optional: Satin VSG 2.2.1 glass, both sides smooth
- Mortice lock, key operated (can be replaced with a lock with blocking option, a Euro profile cylinder lock, or without a keyhole)
- Screw-fixing pivot hinges, 3pcs

PRESTIGE PC PRICING

Colour group	Price	
	Glass: Tempered satin	Glass: Satin VSG 2.2.1
CPL	£ 285,50	Ref. pricing to the left + additional cost in the table below
CLPL	£ 272,00	
FF	£ 237,00	

ALTERNATIVE GLAZING PRICES - SATIN VSG 2.2.1 GLASS

PC-01	PC-02	PC-03	PC-04	PC-05	PC-06
-	£ 125,00	£ 52,50	£ 52,00	£ 88,50	£ 16,50

OPTIONS FOR AN ADDITIONAL CHARGE

NON-STANDARD WIDTH	ADDITIONAL COST
Width 100	£ 30,50
Width less than 60	£ 188,00
Non-standard width, door leaf with Satin deco, Lacomat or Satin VSG 2.2.1 glass	£ 92,00
NON-STANDARD HEIGHT	ADDITIONAL COST
Shorter, up to 60 mm	£ 26,00
Shorter, more than 60 mm (requires evaluation of manufacturability) door leaf with Satin deco, Lacomat or Satin VSG 2.2.1 glass	£ 96,50
Taller, up to 470 mm (requires evaluation of manufacturability) door leaf with Satin deco, Lacomat or Satin VSG 2.2.1 glass	£ 96,50
Extra hinge (required for all door leaves 110 mm to 470 mm taller)	£ 10,50
Extra hinge for the SIMPLE non-rebated system (required for all door leaves 110 mm to 470 mm taller)	£ 39,50
Repositioned lock (recommended for non-standard door height)	£ 30,50
Modification of model due to non-standard door height	£ 43,50
VENTILATION	ADDITIONAL COST
Ventilation cut	£ 13,50
Metal ventilation sleeves in nickel or bronze colour (piece)	£ 13,50
Plastic door grille, matt silver, fits door leaf sizes 80, 90 and 100	£ 26,00
OTHER	ADDITIONAL COST
SIMPLE non-rebated door leaf	£ 87,00
Sliding non-rebated door leaf (not applicable for PP colour group)	£ 21,50
Double door inactive leaf, width S2 420-609 mm	£ 188,00
Double door inactive leaf, width S2 610 mm, 710 mm, 810 mm, 910 mm	£ 39,50
Double door inactive leaf, width: S2 1010 mm	£ 70,00
Drop-down seal	£ 43,00

AVAILABLE COLOURS:

CPL GROUP

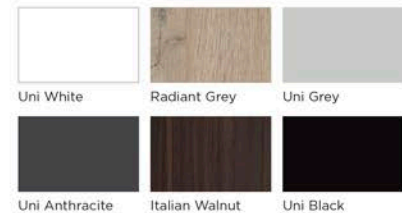

CLPL GROUP

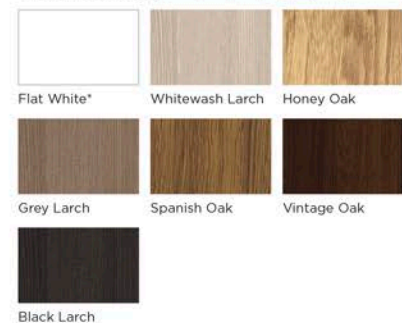

FF GROUP

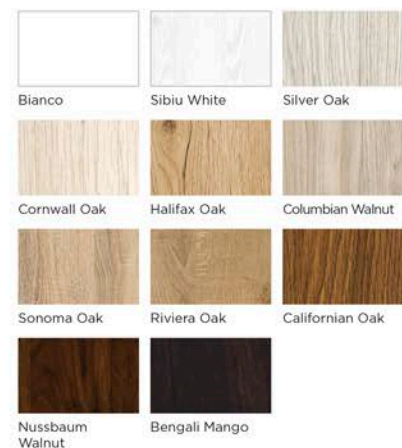

* While stocks last

NEW ARRIVAL

PRESTIGE PE-02, CPL Uni Anthracite

PRESTIGE
PE /



COLOUR: FF White Sibiu



PE-01



PE-02



PE-03



PE-04



PE-05

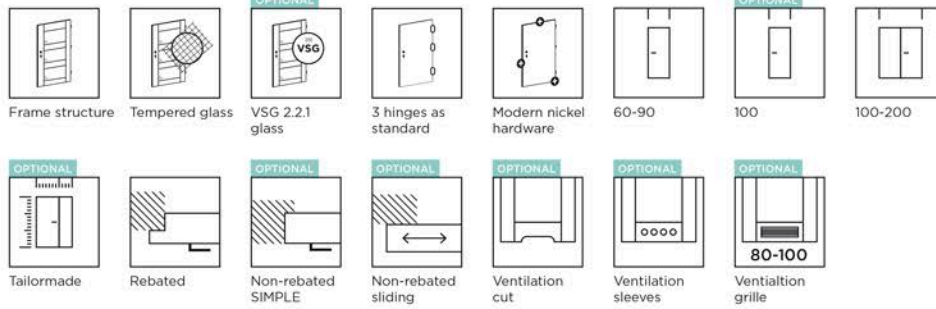

AVAILABLE WIDTH OPTIONS

- 60, 70, 80, 90, other sizes available for an additional charge

STRUCTURE

- Stable frame structure of MDF

FRAME VERSIONS

- fixed: timber & MDF
- adjustable: DIN, DUALE, ZOS

FITTINGS

- Satin tempered glass, thickness: 4 mm
- Optional: Satin VSG 2.2.1 glass, both sides smooth
- Mortice lock, key operated (can be replaced with a lock with blocking option, a Euro profile cylinder lock, or without a keyhole)
- Screw-fixing pivot hinges, 3pcs

PRESTIGE PE PRICING

Colour group	Price	
	Glass: Tempered satin	Glass: Satin VSG 2.2.1
CPL	£ 316,50	Ref. pricing to the left + additional cost in the table below
CLPL	£ 303,00	
FF	£ 241,50	

ALTERNATIVE GLAZING PRICES - SATIN VSG 2.2.1 GLASS

PE-01	PE-02	PE-03	PE-04	PE-05
-	£ 21,00	£ 10,50	£ 10,50	£ 10,50

OPTIONS FOR AN ADDITIONAL CHARGE

NON-STANDARD WIDTH	ADDITIONAL COST
Width 100	£ 30,50
Width less than 60	£ 188,00
Non-standard width, door leaf with Satin deco, Lacomat or Satin VSG 2.2.1 glass	£ 92,00
NON-STANDARD HEIGHT	ADDITIONAL COST
Shorter, up to 60 mm	£ 26,00
Shorter, more than 60 mm (requires evaluation of manufacturability) door leaf with Satin deco, Lacomat or Satin VSG 2.2.1 glass	£ 96,50
Taller, up to 470 mm (requires evaluation of manufacturability) door leaf with Satin deco, Lacomat or Satin VSG 2.2.1 glass	£ 96,50
Extra hinge (required for all door leaves 110 mm to 470 mm taller)	£ 10,50
Extra hinge for the SIMPLE non-rebated system (required for all door leaves 110 mm to 470 mm taller)	£ 39,50
Repositioned lock (recommended for non-standard door height)	£ 30,50
Modification of model due to non-standard door height	£ 43,50
VENTILATION	ADDITIONAL COST
Ventilation cut	£ 13,50
Metal ventilation sleeves in nickel or bronze colour (piece)	£ 13,50
Plastic door grille, matt silver, fits door leaf sizes 80, 90 and 100	£ 26,00
OTHER	ADDITIONAL COST
SIMPLE non-rebated door leaf	£ 87,00
Sliding non-rebated door leaf (not applicable for PP colour group)	£ 21,50
Double door inactive leaf, width S2 420-609 mm	£ 188,00
Double door inactive leaf, width S2 610 mm, 710 mm, 810 mm, 910 mm	£ 39,50
Double door inactive leaf, width: S2 1010 mm	£ 70,00
Drop-down seal	£ 43,00

AVAILABLE COLOURS:

CPL GROUP

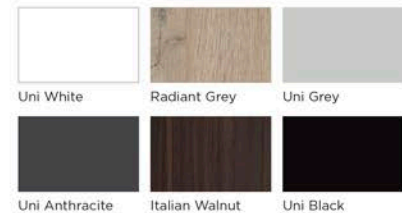

CLPL GROUP

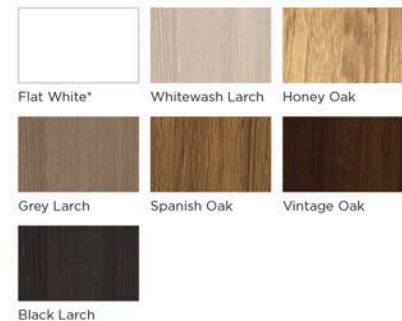

FF GROUP

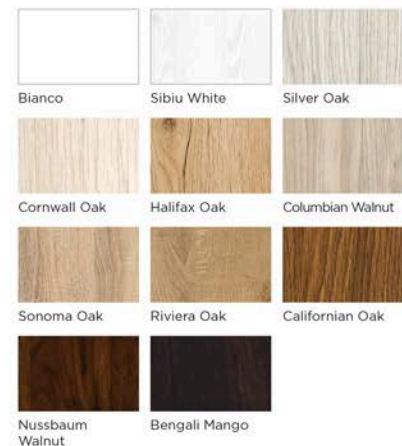

* While stocks last

PRESTIGE PH-02, FF Cornwall Oak

PRESTIGE PH /



COLOUR: CLPL Vintage Oak



PH-01



PH-02



PH-03



PH-04



PH-05



PH-06

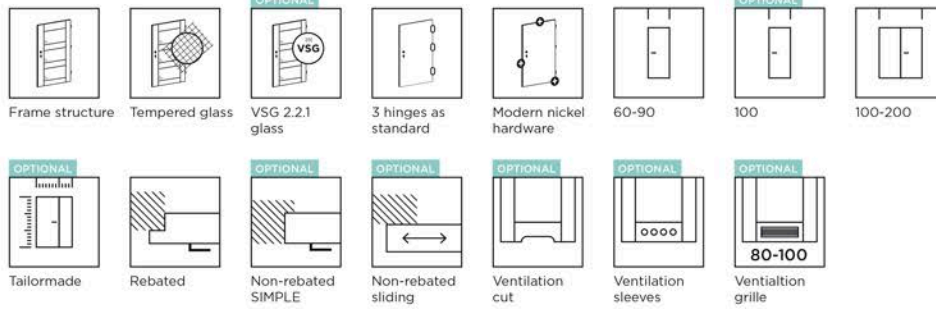

AVAILABLE WIDTH OPTIONS

- 60, 70, 80, 90, other sizes available for an additional charge

STRUCTURE

- Stable frame structure of MDF

FRAME VERSIONS

- fixed: timber & MDF
- adjustable: DIN, DUALE, ZOS

FITTINGS

- Satin tempered glass, thickness: 4 mm
- Optional: Satin VSG 2.2.1 glass, both sides smooth
- Mortice lock, key operated (can be replaced with a lock with blocking option, a Euro profile cylinder lock, or without a keyhole)
- Screw-fixing pivot hinges, 3pcs

PRESTIGE PH PRICING

Colour group	Price	
	Glass: Tempered satin	Glass: Satin VSG 2.2.1
CPL	£ 303,00	Ref. pricing to the left + additional cost in the table below
CLPL	£ 289,50	
FF	£ 241,50	

ALTERNATIVE GLAZING PRICES - SATIN VSG 2.2.1 GLASS

PH-01	PH-02	PH-03	PH-04	PH-05	PH-06
-	£ 70,00	£ 17,50	£ 35,00	£ 35,00	£ 52,50

OPTIONS FOR AN ADDITIONAL CHARGE

NON-STANDARD WIDTH	ADDITIONAL COST
Width 100	£ 30,50
Width less than 60	£ 188,00
Non-standard width, door leaf with Satin deco, Lacomat or Satin VSG 2.2.1 glass	£ 92,00
NON-STANDARD HEIGHT	ADDITIONAL COST
Shorter, up to 60 mm	£ 26,00
Shorter, more than 60 mm (requires evaluation of manufacturability) door leaf with Satin deco, Lacomat or Satin VSG 2.2.1 glass	£ 96,50
Taller, up to 470 mm (requires evaluation of manufacturability) door leaf with Satin deco, Lacomat or Satin VSG 2.2.1 glass	£ 96,50
Extra hinge (required for all door leaves 110 mm to 470 mm taller)	£ 10,50
Extra hinge for the SIMPLE non-rebated system (required for all door leaves 110 mm to 470 mm taller)	£ 39,50
Repositioned lock (recommended for non-standard door height)	£ 39,50
Modification of model due to non-standard door height	£ 43,50
VENTILATION	ADDITIONAL COST
Ventilation cut	£ 13,50
Metal ventilation sleeves in nickel or bronze colour (piece)	£ 13,50
Plastic door grille, matt silver, fits door leaf sizes 80, 90 and 100	£ 26,00
OTHER	ADDITIONAL COST
SIMPLE non-rebated door leaf	£ 87,00
Sliding non-rebated door leaf (not applicable for PP colour group)	£ 21,50
Double door inactive leaf, width S2 420-609 mm	£ 188,00
Double door inactive leaf, width S2 610 mm, 710 mm, 810 mm, 910 mm	£ 39,50
Double door inactive leaf, width: S2 1010 mm	£ 70,00
Drop-down seal	£ 43,00

AVAILABLE COLOURS:

CPL GROUP

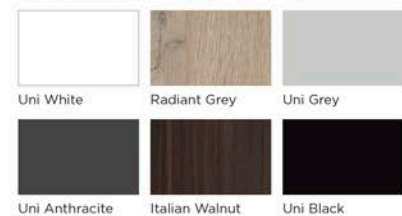

CLPL GROUP

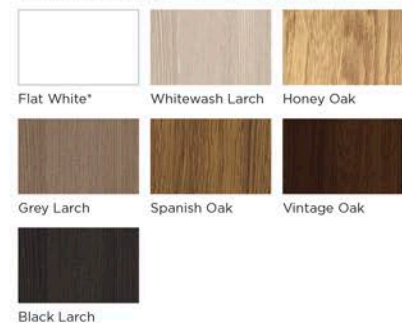

FF GROUP

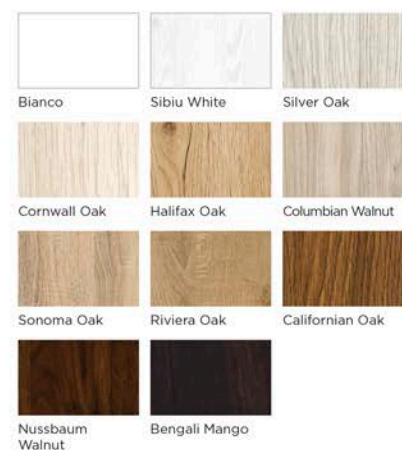

* While stocks last



PRESTIGE PI-02, FF Californian Oak

PRESTIGE
PI /

COLOUR: FF Mango Bengali



PI-01



PI-02



PI-03



PI-04



PI-05



PI-06

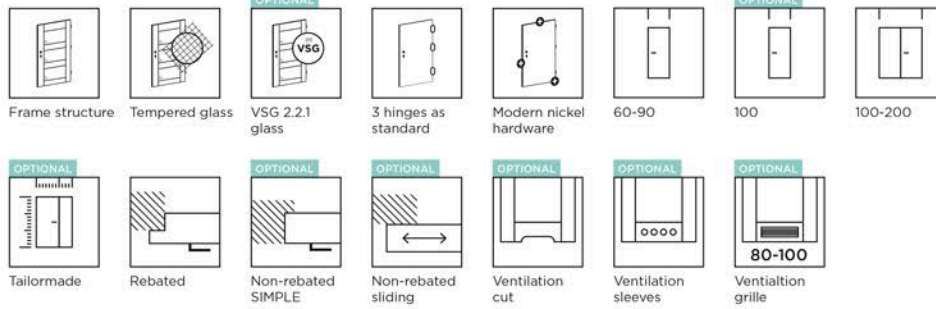

AVAILABLE WIDTH OPTIONS

- 60, 70, 80, 90, other sizes available for an additional charge

STRUCTURE

- Stable frame structure of MDF

FRAME VERSIONS

- fixed: timber & MDF
- adjustable: DIN, DUALE, ZOS

FITTINGS

- Satin tempered glass, thickness: 4 mm
- Optional: Satin VSG 2.2.1 glass, both sides smooth
- Mortice lock, key operated (can be replaced with a lock with blocking option, a Euro profile cylinder lock, or without a keyhole)
- Screw-fixing pivot hinges, 3pcs

PRESTIGE PI PRICING

Colour group	Price	
	Glass: Tempered satin	Glass: Satin VSG 2.2.1
CPL	£ 276,50	Ref. pricing to the left + additional cost in the table below
CLPL	£ 263,00	
FF	£ 232,50	

ALTERNATIVE GLAZING PRICES - SATIN VSG 2.2.1 GLASS

PI-01	PI-02	PI-03	PI-04	PI-05	PI-06
-	£ 125,50	£ 93,50	£ 31,00	£ 62,50	£ 62,50

OPTIONS FOR AN ADDITIONAL CHARGE

NON-STANDARD WIDTH	ADDITIONAL COST
Width 100	£ 30,50
Width less than 60	£ 188,00
Non-standard width, door leaf with Satin deco, Lacomat or Satin VSG 2.2.1 glass	£ 92,00
NON-STANDARD HEIGHT	ADDITIONAL COST
Shorter, up to 60 mm	£ 26,00
Shorter, more than 60 mm (requires evaluation of manufacturability) door leaf with Satin deco, Lacomat or Satin VSG 2.2.1 glass	£ 96,50
Taller, up to 470 mm (requires evaluation of manufacturability) door leaf with Satin deco, Lacomat or Satin VSG 2.2.1 glass	£ 96,50
Extra hinge (required for all door leaves 110 mm to 470 mm taller)	£ 10,50
Extra hinge for the SIMPLE non-rebated system (required for all door leaves 110 mm to 470 mm taller)	£ 39,50
Repositioned lock (recommended for non-standard door height)	£ 30,50
Modification of model due to non-standard door height	£ 43,50
VENTILATION	ADDITIONAL COST
Ventilation cut	£ 13,50
Metal ventilation sleeves in nickel or bronze colour (piece)	£ 13,50
Plastic door grille, matt silver, fits door leaf sizes 80, 90 and 100	£ 26,00
OTHER	ADDITIONAL COST
SIMPLE non-rebated door leaf	£ 87,00
Sliding non-rebated door leaf (not applicable for PP colour group)	£ 21,50
Double door inactive leaf, width S2 420-609 mm	£ 188,00
Double door inactive leaf, width S2 610 mm, 710 mm, 810 mm, 910 mm	£ 39,50
Double door inactive leaf, width: S2 1010 mm	£ 70,00
Drop-down seal	£ 43,00

AVAILABLE COLOURS:

CPL GROUP      

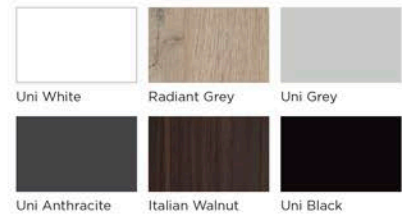

CLPL GROUP      

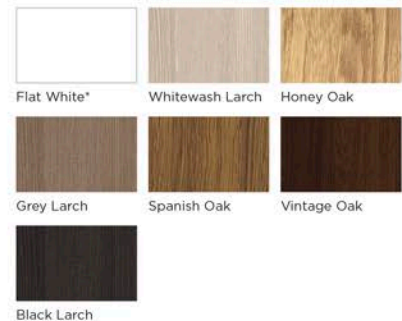

FF GROUP     

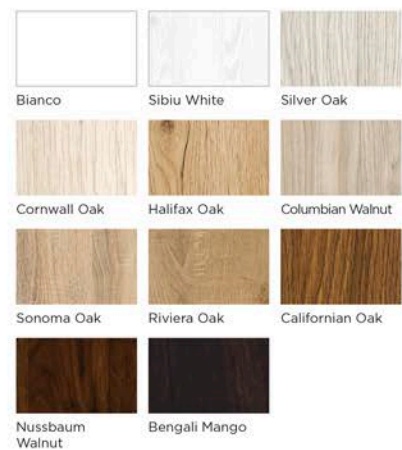

* While stocks last

NEW ARRIVAL

PRESTIGE PJ-01, FF Riviera Oak

PRESTIGE
PJ



COLOUR: FF Nussbaum Walnut



PJ-01

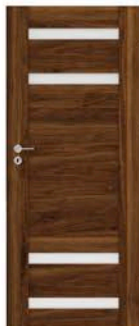

PJ-02



PJ-03

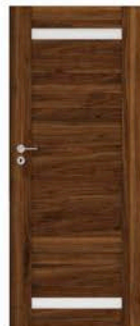

PJ-04



PJ-05

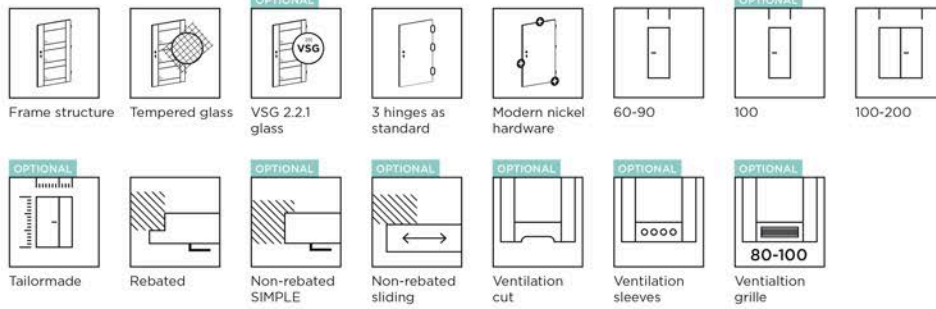

AVAILABLE WIDTH OPTIONS

- 60, 70, 80, 90, other sizes available for an additional charge

STRUCTURE

- Stable frame structure of MDF

FRAME VERSIONS

- fixed: timber & MDF
- adjustable: DIN, DUALE, ZOS

FITTINGS

- Satin tempered glass, thickness: 4 mm
- Optional: Satin VSG 2.2.1 glass, both sides smooth
- Mortice lock, key operated (can be replaced with a lock with blocking option, a Euro profile cylinder lock, or without a keyhole)
- Screw-fixing pivot hinges, 3pcs

PRESTIGE PJ PRICING

Colour group	Price	
	Glass: Tempered satin	Glass: Satin VSG 2.2.1
CPL	£ 316,00	Ref. pricing to the left + additional cost in the table below
CLPL	£ 303,00	
FF	£ 241,50	

ALTERNATIVE GLAZING PRICES - SATIN VSG 2.2.1 GLASS

PJ-01	PJ-02	PJ-03	PJ-04	PJ-05
-	£ 21,00	£ 10,50	£ 10,50	£ 10,50

OPTIONS FOR AN ADDITIONAL CHARGE

NON-STANDARD WIDTH	ADDITIONAL COST
Width 100	£ 30,50
Width less than 60	£ 188,00
Non-standard width, door leaf with Satin deco, Lacomat or Satin VSG 2.2.1 glass	£ 92,00
NON-STANDARD HEIGHT	ADDITIONAL COST
Shorter, up to 60 mm	£ 26,00
Shorter, more than 60 mm (requires evaluation of manufacturability) door leaf with Satin deco, Lacomat or Satin VSG 2.2.1 glass	£ 96,50
Taller, up to 470 mm (requires evaluation of manufacturability) door leaf with Satin deco, Lacomat or Satin VSG 2.2.1 glass	£ 96,50
Extra hinge (required for all door leaves 110 mm to 470 mm taller)	£ 10,50
Extra hinge for the SIMPLE non-rebated system (required for all door leaves 110 mm to 470 mm taller)	£ 39,50
Repositioned lock (recommended for non-standard door height)	£ 30,50
Modification of model due to non-standard door height	£ 43,50
VENTILATION	ADDITIONAL COST
Ventilation cut	£ 13,50
Metal ventilation sleeves in nickel or bronze colour (piece)	£ 13,50
Plastic door grille, matt silver, fits door leaf sizes 80, 90 and 100	£ 26,00
OTHER	ADDITIONAL COST
SIMPLE non-rebated door leaf	£ 87,00
Sliding non-rebated door leaf (not applicable for PP colour group)	£ 21,50
Double door inactive leaf, width S2 420-609 mm	£ 188,00
Double door inactive leaf, width S2 610 mm, 710 mm, 810 mm, 910 mm	£ 39,50
Double door inactive leaf, width: S2 1010 mm	£ 70,00
Drop-down seal	£ 43,00

AVAILABLE COLOURS:

CPL GROUP

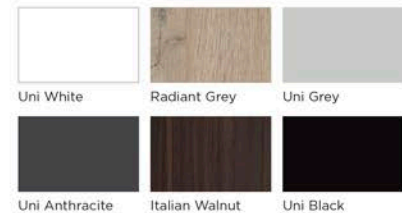

CLPL GROUP

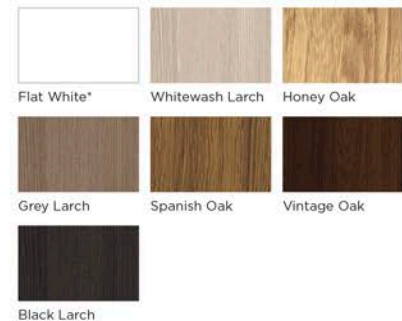

FF GROUP

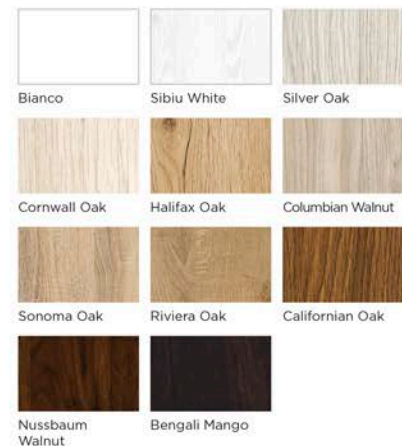

* While stocks last



PRESTIGE PK-02, CLPL Honey Oak

PRESTIGE PK

COLOUR: CLPL Honey Oak



PK-01

PK-02

PK-03

PK-04

PK-05

PK-06

PK-07

PK-08

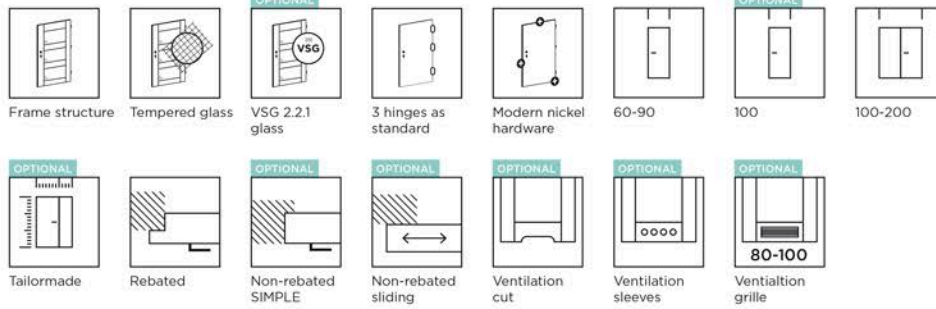

AVAILABLE WIDTH OPTIONS

- 60, 70, 80, 90, other sizes available for an additional charge

STRUCTURE

- Stable frame structure of MDF

FRAME VERSIONS

- fixed: timber & MDF
- adjustable: DIN, DUALE, ZOS

FITTINGS

- Satin tempered glass, thickness: 4 mm
- Optional: Satin VSG 2.2.1 glass, both sides smooth
- Mortice lock, key operated (can be replaced with a lock with blocking option, a Euro profile cylinder lock, or without a keyhole)
- Screw-fixing pivot hinges, 3pcs

PRESTIGE PK PRICING

Colour group	Price	
	Glass: Tempered satin	Glass: Satin VSG 2.2.1
CPL	£ 254,00	Ref. pricing to the left + additional cost in the table below
CLPL	£ 241,50	
FF	£ 210,50	

ALTERNATIVE GLAZING PRICES - SATIN VSG 2.2.1 GLASS

PK-01	PK-02	PK-03	PK-04	PK-05	PK-06	PK-07	PK-08
-	£ 131,50	£ 26,50	£ 52,50	£ 79,00	£ 79,00	£ 79,00	£ 105,50

OPTIONS FOR AN ADDITIONAL CHARGE

NON-STANDARD WIDTH	ADDITIONAL COST
Width 100	£ 30,50
Width less than 60	£ 188,00
Non-standard width, door leaf with Satin deco, Lacomat or Satin VSG 2.2.1 glass	£ 92,00
NON-STANDARD HEIGHT	ADDITIONAL COST
Shorter, up to 60 mm	£ 26,00
Shorter, more than 60 mm (requires evaluation of manufacturability) door leaf with Satin deco, Lacomat or Satin VSG 2.2.1 glass	£ 96,50
Taller, up to 470 mm (requires evaluation of manufacturability) door leaf with Satin deco, Lacomat or Satin VSG 2.2.1 glass	£ 96,50
Extra hinge (required for all door leaves 110 mm to 470 mm taller)	£ 10,50
Extra hinge for the SIMPLE non-rebated system (required for all door leaves 110 mm to 470 mm taller)	£ 39,50
Repositioned lock (recommended for non-standard door height)	£ 30,50
Modification of model due to non-standard door height	£ 43,50
VENTILATION	ADDITIONAL COST
Ventilation cut	£ 13,50
Metal ventilation sleeves in nickel or bronze colour (piece)	£ 13,50
Plastic door grille, matt silver, fits door leaf sizes 80, 90 and 100	£ 26,00
OTHER	ADDITIONAL COST
SIMPLE non-rebated door leaf	£ 87,00
Sliding non-rebated door leaf (not applicable for PP colour group)	£ 21,50
Double door inactive leaf, width S2 420-609 mm	£ 188,00
Double door inactive leaf, width S2 610 mm, 710 mm, 810 mm, 910 mm	£ 39,50
Double door inactive leaf, width: S2 1010 mm	£ 70,00
Drop-down seal	£ 43,00

AVAILABLE COLOURS:

CPL GROUP

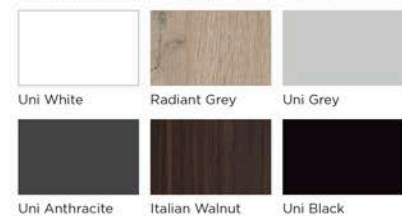

CLPL GROUP

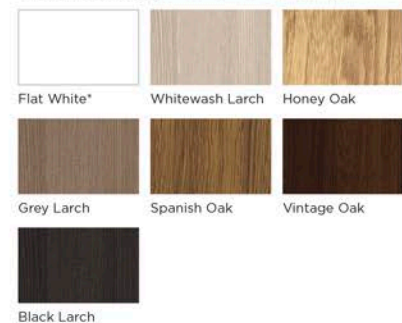

FF GROUP

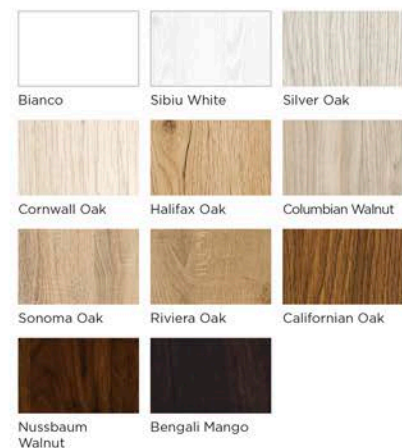

* While stocks last



PRESTIGE PL-02, CLPL Vintage Oak

PRESTIGE PL /

COLOUR: CLPL Honey Oak



PL-01



PL-02



PL-03



PL-04



PL-05

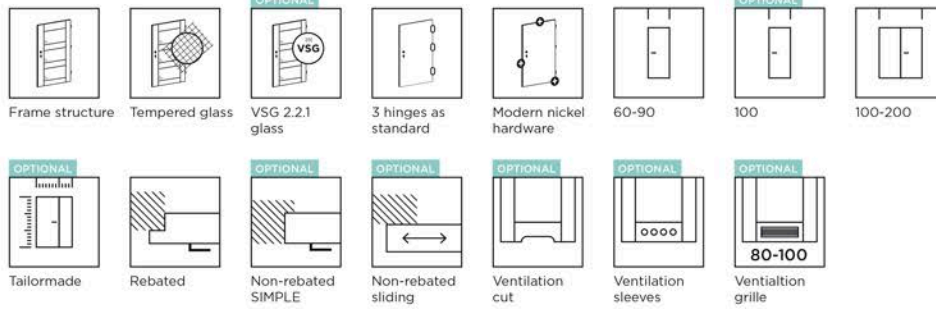

AVAILABLE WIDTH OPTIONS

- 60, 70, 80, 90, other sizes available for an additional charge

STRUCTURE

- Stable frame structure of MDF

FRAME VERSIONS

- fixed: timber & MDF
- adjustable: DIN, DUALE, ZOS

FITTINGS

- Satin tempered glass, thickness: 4 mm
- Optional: Satin VSG 2.2.1 glass, both sides smooth
- Mortice lock, key operated (can be replaced with a lock with blocking option, a Euro profile cylinder lock, or without a keyhole)
- Screw-fixing pivot hinges, 3pcs

PRESTIGE PI PRICING

Colour group	Price	
	Glass: Tempered satin	Glass: Satin VSG 2.2.1
CPL	£ 333,50	Ref. pricing to the left + additional cost in the table below
CLPL	£ 316,00	
FF	£ 259,00	

ALTERNATIVE GLAZING PRICES - SATIN VSG 2.2.1 GLASS

PL-01	PL-02	PL-03	PL-04	PL-05
-	£ 63,00	£ 23,50	£ 31,50	£ 39,50

OPTIONS FOR AN ADDITIONAL CHARGE

NON-STANDARD WIDTH	ADDITIONAL COST
Width 100	£ 30,50
Width less than 60	£ 188,00
Non-standard width, door leaf with Satin deco, Lacomat or Satin VSG 2.2.1 glass	£ 92,00
NON-STANDARD HEIGHT	ADDITIONAL COST
Shorter, up to 60 mm	£ 26,00
Shorter, more than 60 mm (requires evaluation of manufacturability) door leaf with Satin deco, Lacomat or Satin VSG 2.2.1 glass	£ 96,50
Taller, up to 470 mm (requires evaluation of manufacturability) door leaf with Satin deco, Lacomat or Satin VSG 2.2.1 glass	£ 96,50
Extra hinge (required for all door leaves 110 mm to 470 mm taller)	£ 10,50
Extra hinge for the SIMPLE non-rebated system (required for all door leaves 110 mm to 470 mm taller)	£ 39,50
Repositioned lock (recommended for non-standard door height)	£ 30,50
Modification of model due to non-standard door height	£ 43,50
VENTILATION	ADDITIONAL COST
Ventilation cut	£ 13,50
Metal ventilation sleeves in nickel or bronze colour (piece)	£ 13,50
Plastic door grille, matt silver, fits door leaf sizes 80, 90 and 100	£ 26,00
OTHER	ADDITIONAL COST
SIMPLE non-rebated door leaf	£ 87,00
Sliding non-rebated door leaf (not applicable for PP colour group)	£ 21,50
Double door inactive leaf, width S2 420-609 mm	£ 188,00
Double door inactive leaf, width S2 610 mm, 710 mm, 810 mm, 910 mm	£ 39,50
Double door inactive leaf, width: S2 1010 mm	£ 70,00
Drop-down seal	£ 43,00

AVAILABLE COLOURS:

CPL GROUP      

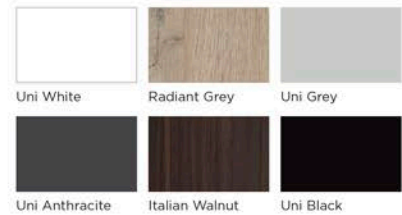

CLPL GROUP      

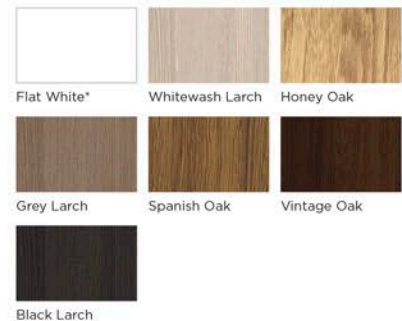

FF GROUP      

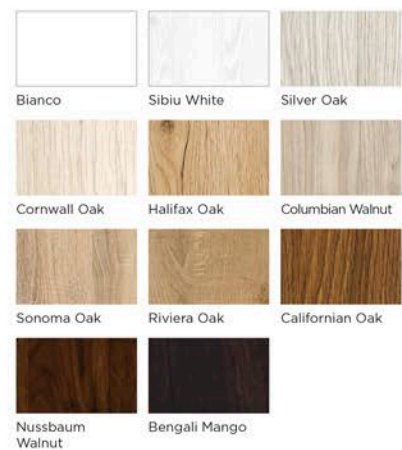

* While stocks last

NEW ARRIVAL

PRESTIGE PN-01, CPL Italian Walnut

PRESTIGE PN /

COLOUR: FF Cornwall Oak



PN-01



PN-02



PN-03



PN-04



PN-05

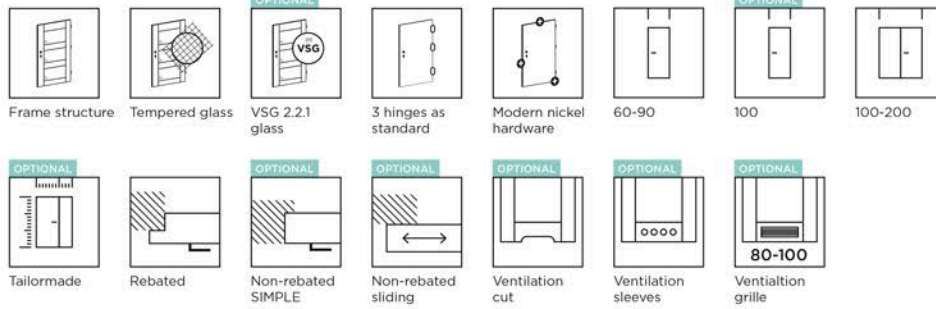

AVAILABLE WIDTH OPTIONS

- 60, 70, 80, 90, other sizes available for an additional charge

STRUCTURE

- Stable frame structure of MDF

FRAME VERSIONS

- fixed: timber & MDF
- adjustable: DIN, DUALE, ZOS

FITTINGS

- Satin tempered glass, thickness: 4 mm
- Optional: Satin VSG 2.2.1 glass, both sides smooth
- Mortice lock, key operated (can be replaced with a lock with blocking option, a Euro profile cylinder lock, or without a keyhole)
- Screw-fixing pivot hinges, 3pcs

PRESTIGE PN PRICING

Colour group	Price	
	Glass: Tempered satin	Glass: Satin VSG 2.2.1
CPL	£ 311,50	Ref. pricing to the left + additional cost in the table below
CLPL	£ 294,00	
FF	£ 241,50	

ALTERNATIVE GLAZING PRICES - SATIN VSG 2.2.1 GLASS

PN-01	PN-02	PN-03	PN-04	PN-05
-	£ 40,00	£ 20,00	£ 20,00	£ 20,00

OPTIONS FOR AN ADDITIONAL CHARGE

NON-STANDARD WIDTH	ADDITIONAL COST
Width 100	£ 30,50
Width less than 60	£ 188,00
Non-standard width, door leaf with Satin deco, Lacomat or Satin VSG 2.2.1 glass	£ 92,00
NON-STANDARD HEIGHT	ADDITIONAL COST
Shorter, up to 60 mm	£ 26,00
Shorter, more than 60 mm (requires evaluation of manufacturability) door leaf with Satin deco, Lacomat or Satin VSG 2.2.1 glass	£ 96,50
Taller, up to 470 mm (requires evaluation of manufacturability) door leaf with Satin deco, Lacomat or Satin VSG 2.2.1 glass	£ 96,50
Extra hinge (required for all door leaves 110 mm to 470 mm taller)	£ 10,50
Extra hinge for the SIMPLE non-rebated system (required for all door leaves 110 mm to 470 mm taller)	£ 39,50
Repositioned lock (recommended for non-standard door height)	£ 30,50
Modification of model due to non-standard door height	£ 43,50
VENTILATION	ADDITIONAL COST
Ventilation cut	£ 13,50
Metal ventilation sleeves in nickel or bronze colour (piece)	£ 13,50
Plastic door grille, matt silver, fits door leaf sizes 80, 90 and 100	£ 26,00
OTHER	ADDITIONAL COST
SIMPLE non-rebated door leaf	£ 87,00
Sliding non-rebated door leaf (not applicable for PP colour group)	£ 21,50
Double door inactive leaf, width S2 420-609 mm	£ 188,00
Double door inactive leaf, width S2 610 mm, 710 mm, 810 mm, 910 mm	£ 39,50
Double door inactive leaf, width: S2 1010 mm	£ 70,00
Drop-down seal	£ 43,00

AVAILABLE COLOURS:

CPL GROUP

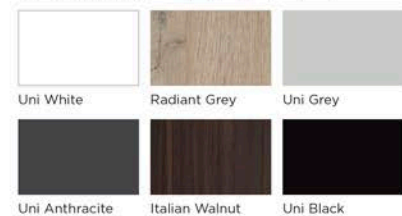

CLPL GROUP

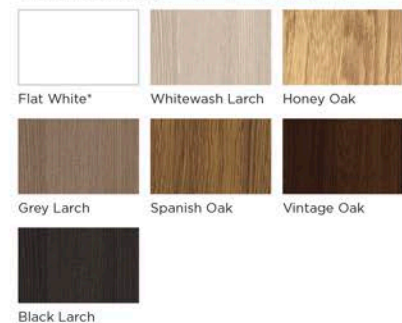

FF GROUP

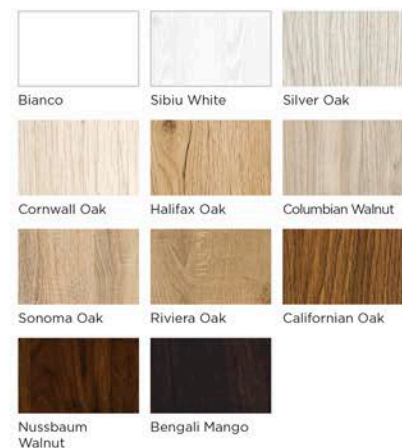

* While stocks last



PRESTIGE PO-01, CLIPPOINT Oak



PRESTIGE PO /

COLOUR: FF Colombian Walnut



PO-01



PO-02
Satin bevelled
tempered
glass



PO-03
Clear bevelled
tempered
glass



PO-04



PO-05
Satin bevelled
tempered
glass



PO-06
Clear bevelled
tempered
glass



Available with PO-02 & PO-05
Clear bevel



Available with PO-03 & PO-06
Clear bevel and pane

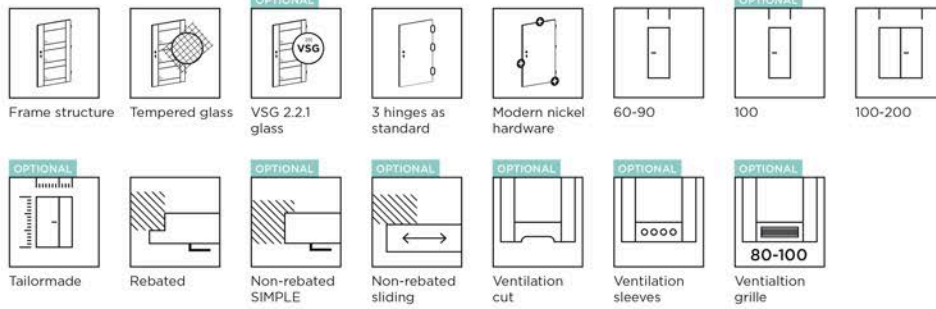

AVAILABLE WIDTH OPTIONS

- 60, 70, 80, 90, other sizes available for an additional charge

STRUCTURE

- Stable frame structure of MDF

FRAME VERSIONS

- fixed: timber & MDF
- adjustable: DIN, DUALE, ZOS

FITTINGS

- 4 mm thick Satin glass or bevelled clear tempered glass
- optional for PO-02 & PO-05 models: bevelled satin VSG 2.2.1 glass, both sides smooth (bevelled satin, opaque)
- optional for PO-03 & PO-06 models
- Mortice lock, key operated (can be replaced with a lock with blocking option or a Euro profile cylinder lock)
- Screw-fixing pivot hinges, 3pcs

PRESTIGE PO PRICING

Colour group	Price		
	Glass: Tempered satin		Glass: Satin VSG 2.2.1
	PO-01, PO-04	PO-02, PO-03, PO-05, PO-06	PO-02, PO-03, PO-05, PO-06
CPL	£ 325,00	£ 465,50	Ref. pricing to the left + additional cost in the table below
CLPL	£ 307,50	£ 448,00	
FF	£ 246,00	£ 421,00	

ALTERNATIVE GLAZING PRICES - SATIN VSG 2.2.1 GLASS

PO-01	PO-02	PO-03	PO-04	PO-05	PO-06
-	£ 219,00	£ 219,00	-	£ 241,50	£ 241,50

AVAILABLE COLOURS:

CPL GROUP

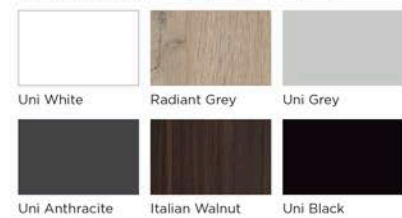

CLPL GROUP

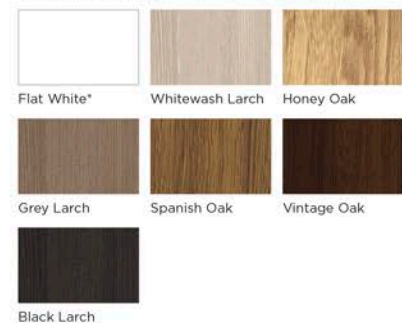

FF GROUP

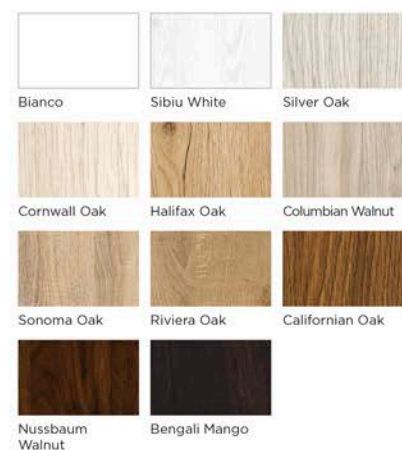

OPTIONAL

NON-STANDARD WIDTH	ADDITIONAL COST
Width: 100	£ 30,50
Width less than 60	£ 188,50
Non-standard width	£ 92,50
NON-STANDARD HEIGHT	ADDITIONAL COST
Shorter, up to 60 mm	£ 26,50
Shorter, more than 60 mm (requires evaluation of manufacturability)	£ 96,50
Door leaf glazed with Satin Deco, Lacomat or Satin VSG 2.2.1	£ 96,50
Taller, up to 470 mm (requires evaluation of manufacturability)	£ 96,50
Door leaf glazed with Satin Deco, Lacomat or Satin VSG 2.2.1	£ 10,50
Extra hinge (required for all door leaves 110 mm to 470 mm taller)	£ 39,50
Extra hinge for the SIMPLE non-rebated system (required for all door leaves 110 mm to 470 mm taller)	£ 30,50
Repositioned lock (recommended for non-standard door height)	£ 44,00
Modification of the model due to non-standard door height	
VENTILATION	ADDITIONAL COST
Ventilation cut	£ 13,50
Ventilation sleeves with nickel or bronze covers (piece)	£ 13,50
Plastic door grille, matt silver, fits door leaf sizes 80, 90 and 100	£ 26,50
OTHER	ADDITIONAL COST
SIMPLE non-rebated door leaf	£ 88,00
Sliding non-rebated door leaf	£ 21,50
Double door inactive leaf, width S2 420-609 mm	£ 188,50
Double door inactive leaf, width S2 61 mm, 71 mm, 81 mm, 91 mm	£ 39,50
Double door inactive leaf (width S2 101 cm)	£ 70,00
Drop-down seal	£ 43,00

* While stocks last



PRESTIGE PP-02, FF Colombian Walnut

PRESTIGE
PP

COLOUR: FF Colombian Walnut



PP-01



PP-02



PP-03



PP-04



PP-05



PP-06

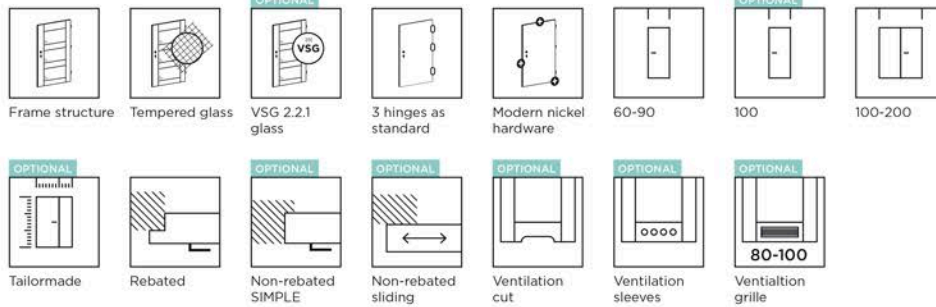

AVAILABLE WIDTH OPTIONS

- 60, 70, 80, 90, other sizes available for an additional charge

STRUCTURE

- Stable frame structure of MDF

FRAME VERSIONS

- fixed: timber & MDF
- adjustable: DIN, DUALE, ZOS

FITTINGS

- Satin tempered glass, thickness: 4 mm
- Optional: Satin VSG 2.2.1 glass, both sides smooth
- Mortice lock, key operated (can be replaced with a lock with blocking option, a Euro profile cylinder lock, or without a keyhole)
- Screw-fixing pivot hinges, 3pcs

PRESTIGE PP PRICING

Colour group	Price	
	Glass: Tempered satin	Glass: Satin VSG 2.2.1
CPL	£ 276,50	Ref. pricing to the left + additional cost in the table below
CLPL	£ 267,50	
FF	£ 224,00	

ALTERNATIVE GLAZING PRICES - SATIN VSG 2.2.1 GLASS

PP-01	PP-02	PP-03	PP-04	PP-05
-	£ 81,50	£ 32,50	£ 48,50	£ 65,00

OPTIONS FOR AN ADDITIONAL CHARGE

NON-STANDARD WIDTH	ADDITIONAL COST
Width: 100	£ 30,50
Width less than 60	£ 188,00
Non-standard width, door leaf with Satin deco, Lacomat or Satin VSG 2.2.1 glass	£ 92,00
NON-STANDARD HEIGHT	ADDITIONAL COST
Shorter, up to 60 mm	£ 26,00
Shorter, more than 60 mm (requires evaluation of manufacturability) door leaf with Satin deco, Lacomat or Satin VSG 2.2.1 glass	£ 96,50
Taller, up to 470 mm (requires evaluation of manufacturability) door leaf with Satin deco, Lacomat or Satin VSG 2.2.1 glass	£ 96,50
Extra hinge (required for all door leaves 110 mm to 470 mm taller)	£ 10,50
Extra hinge for the SIMPLE non-rebated system (required for all door leaves 110 mm to 470 mm taller)	£ 39,50
Repositioned lock (recommended for non-standard door height)	£ 30,50
Modification of model due to non-standard door height	£ 43,50
VENTILATION	ADDITIONAL COST
Ventilation cut	£ 13,50
Metal ventilation sleeves in nickel or bronze colour (piece)	£ 13,50
Plastic door grille, matt silver, fits door leaf sizes 80, 90 and 100	£ 26,00
OTHER	ADDITIONAL COST
SIMPLE non-rebated door leaf	£ 87,00
Sliding non-rebated door leaf (not applicable for PP colour group)	£ 21,50
Double door inactive leaf, width S2 420-609 mm	£ 188,00
Double door inactive leaf, width S2 610 mm, 710 mm, 810 mm, 910 mm	£ 39,50
Double door inactive leaf, width: S2 1010 mm	£ 70,00
Drop-down seal	£ 43,00

AVAILABLE COLOURS:

CPL GROUP

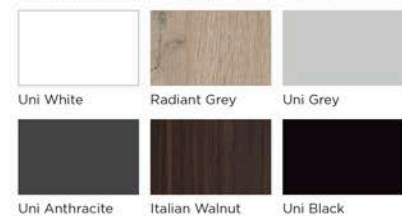

CLPL GROUP

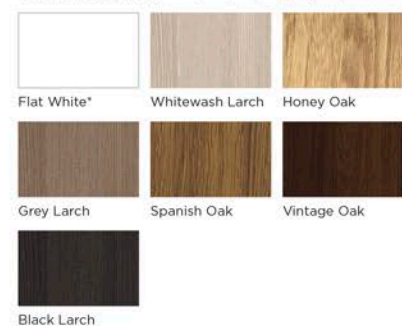

FF GROUP

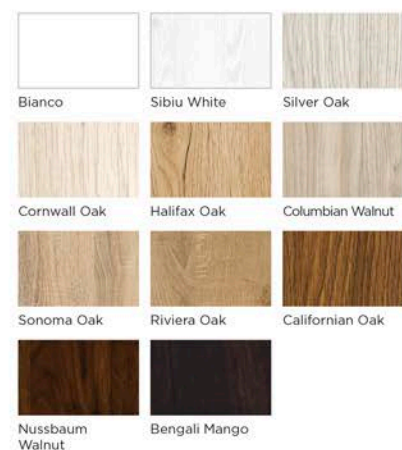

* While stocks last

PRESTIGE PR-02, CLPL Matt White*

PRESTIGE PR



COLOUR: FF Sibiu White



PR-01



PR-02



PR-03



PR-04

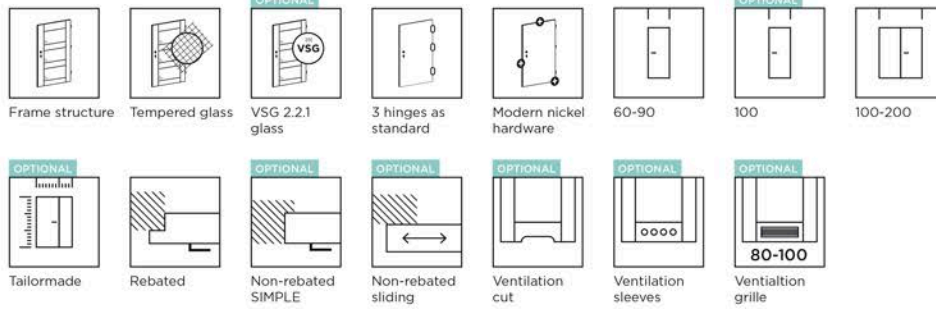

AVAILABLE WIDTH OPTIONS

- 60, 70, 80, 90, other sizes available for an additional charge

STRUCTURE

- Stable frame structure of MDF

FRAME VERSIONS

- fixed: timber & MDF
- adjustable: DIN, DUALE, ZOS

FITTINGS

- Satin tempered glass, thickness: 4 mm
- Optional: Satin VSG 2.2.1 glass, both sides smooth
- Mortice lock, key operated (can be replaced with a lock with blocking option, a Euro profile cylinder lock, or without a keyhole)
- Screw-fixing pivot hinges, 3pcs

PRESTIGE PR PRICING

Colour group	Price	
	Glass: Tempered satin	Glass: Satin VSG 2.2.1
CPL	£ 289,50	Ref. pricing to the left + additional cost in the table below
CLPL	£ 276,50	
FF	£ 232,50	

ALTERNATIVE GLAZING PRICES - SATIN VSG 2.2.1 GLASS

PR-01	PR-02	PR-03	PR-04
-	£ 21,00	-	£ 21,00

OPTIONAL

WIDTH	ADDITIONAL COST
Width: 100	£ 30,50

NON-STANDARD WIDTH

Width less than 60 mm	£ 26,50
Extra hinge	£ 10,50
Extra hinge as part of the non-rebated SIMPLE system	£ 39,50

VENTILATION	ADDITIONAL COST
Ventilation cut	£ 13,50
Ventilation sleeves with nickel or bronze covers (piece)	£ 13,50
Plastic door grille, matt silver, fits door leaf sizes 80, 90 and 100	£ 26,50

OTHER	ADDITIONAL COST
SIMPLE non-rebated door leaf	£ 88,00
Sliding non-rebated door leaf	£ 21,50
Double door inactive leaf, width: S2 w mm: 644 mm, 744 mm, 844 mm, 944 mm (also requires an additional cost for non-standard frame width adjustment)	£ 39,50
Double door inactive leaf, width: S2 1044 mm	£ 70,00
Drop-down seal	£ 43,00

AVAILABLE COLOURS:

CPL GROUP

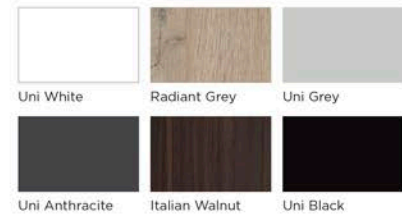

CLPL GROUP

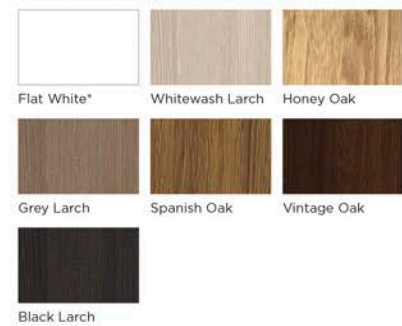

FF GROUP

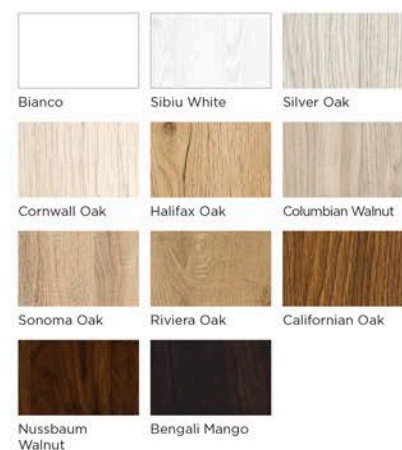

* While stocks last

NEW ARRIVAL

PRESTIGE MI-02, CLPL Honey Oak

PRESTIGE MI /



COLOUR: CLPL Honey Oak



MI-01



MI-02
szer. 60



MI-02
szer. 70



MI-02
szer. 80



MI-02
szer. 90

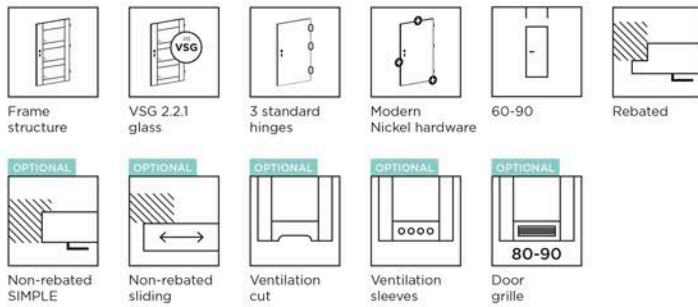

AVAILABLE WIDTH OPTIONS

- 60, 70, 80, 90

STRUCTURE

- Stable frame structure of MDF

FRAME VERSIONS

- Fixed: timber & MDF
- Adjustable: DIN, DUALE, ZOS

FIXTURES

- Black VSG 2.2.1 glass, both sides smooth
- Mortice lock, key operated (can be replaced with a lock with blocking option, a Euro profile cylinder lock, or without a keyhole)
- Screw-fixing pivot hinges, 3pcs

PRESTIGE MI PRICING

Colour group	Price
CLPL	£ 351,50

AVAILABLE COLOURS:

CLPL GROUP



Honey Oak

OPTIONS FOR AN ADDITIONAL COST

NON-STANDARD HEIGHT	ADDITIONAL COST
Shorter, up to 60 mm	£ 26,50
Extra hinge	£ 10,50
Extra hinge as part of the non-rebated SIMPLE system	£ 39,50
VENTILATION	ADDITIONAL COST
Ventilation cut	£ 13,50
Metal ventilation sleeves in nickel or bronze colour (piece)	£ 13,50
Plastic door grille, matt silver, fits door leaf sizes 80 and 90	£ 26,50
OTHER	ADDITIONAL COST
SIMPLE non-rebated door leaf	£ 87,50
Sliding non-rebated door leaf	£ 21,50
Double door inactive leaf, width: S2 w mm: 644 mm, 744 mm, 844 mm, 944 mm (also requires an additional cost for non-standard frame width adjustment)	£ 39,50
Drop-down seal	£ 43,00

* While stocks last

PRESTIGE PT-02, CLPL Spanish Oak

PRESTIGE PT



COLOUR: CPL Uni Anthracite



PT-01



PT-02



PT-03



PT-04



PT-05



PT-06

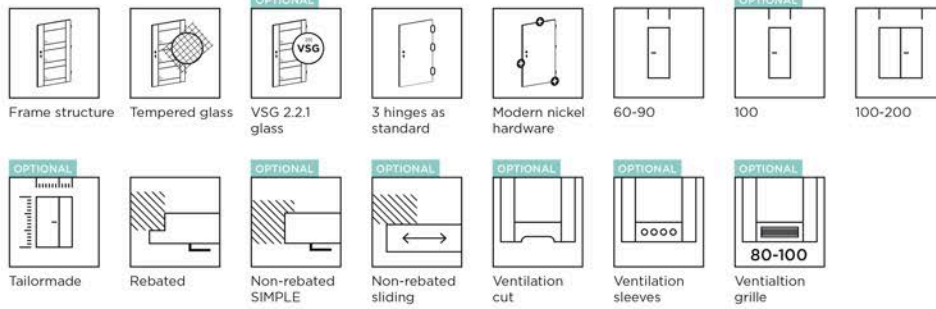

AVAILABLE WIDTH OPTIONS

- 60, 70, 80, 90, other sizes available for an additional charge

STRUCTURE

- Stable frame structure of MDF

FRAME VERSIONS

- fixed: timber & MDF
- adjustable: DIN, DUALE, ZOS

FITTINGS

- Satin tempered glass, thickness: 4 mm
- Optional: Satin VSG 2.2.1 glass, both sides smooth
- Mortice lock, key operated (can be replaced with a lock with blocking option, a Euro profile cylinder lock, or without a keyhole)
- Screw-fixing pivot hinges, 3pcs

PRESTIGE PT PRICING

Colour group	Price	
	Glass: Tempered satin	Glass: Satin VSG 2.2.1
CPL	£ 285,50	Ref. pricing to the left + additional cost in the table below
CLPL	£ 272,00	
FF	£ 232,50	

DALTERNATIVE GLAZING PRICES - SATIN VSG 2.2.1 GLASS

PT-01	PT-02	PT-03	PT-04	PT-05	PT-06
-	£ 105,50	£ 79,00	£ 26,50	£ 52,50	£ 52,50

OPTIONS FOR AN ADDITIONAL CHARGE

NON-STANDARD WIDTH	ADDITIONAL COST
Width 100	£ 30,50
Width less than 60	£ 188,00
Non-standard width, door leaf with Satin deco, Lacomat or Satin VSG 2.2.1 glass	£ 92,00
NON-STANDARD HEIGHT	ADDITIONAL COST
Shorter, up to 60 mm	£ 26,00
Shorter, more than 60 mm (requires evaluation of manufacturability) door leaf with Satin deco, Lacomat or Satin VSG 2.2.1 glass	£ 96,50
Taller, up to 470 mm (requires evaluation of manufacturability) door leaf with Satin deco, Lacomat or Satin VSG 2.2.1 glass	£ 96,50
Extra hinge (required for all door leaves 110 mm to 470 mm taller)	£ 10,50
Extra hinge for the SIMPLE non-rebated system (required for all door leaves 110 mm to 470 mm taller)	£ 39,50
Repositioned lock (recommended for non-standard door height)	£ 30,50
Modification of model due to non-standard door height	£ 43,50
VENTILATION	ADDITIONAL COST
Ventilation cut	£ 13,50
Metal ventilation sleeves in nickel or bronze colour (piece)	£ 13,50
Plastic door grille, matt silver, fits door leaf sizes 80, 90 and 100	£ 26,00
OTHER	ADDITIONAL COST
SIMPLE non-rebated door leaf	£ 87,00
Sliding non-rebated door leaf (not applicable for PP colour group)	£ 21,50
Double door inactive leaf, width S2 420-609 mm	£ 188,00
Double door inactive leaf, width S2 610 mm, 710 mm, 810 mm, 910 mm	£ 39,50
Double door inactive leaf, width: S2 1010 mm	£ 70,00
Drop-down seal	£ 43,00

AVAILABLE COLOURS:

CPL GROUP

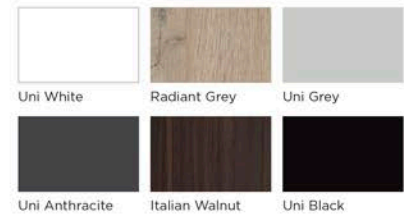

CLPL GROUP

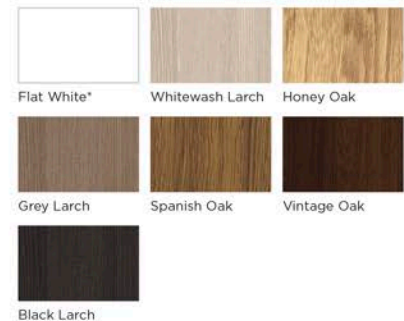

FF GROUP

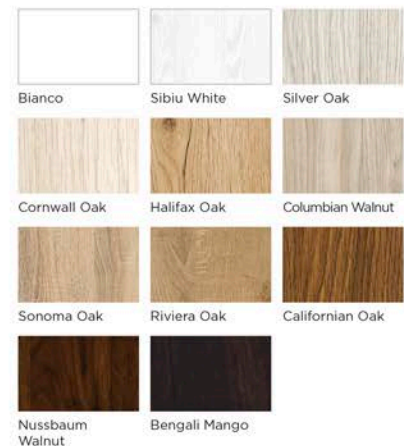

* While stocks last



PRESTIGE-PU-02, CH

PRESTIGE PU /

COLOUR: FF Cornwall Oak



PU-01

PU-02

PU-03

PU-04

PU-05

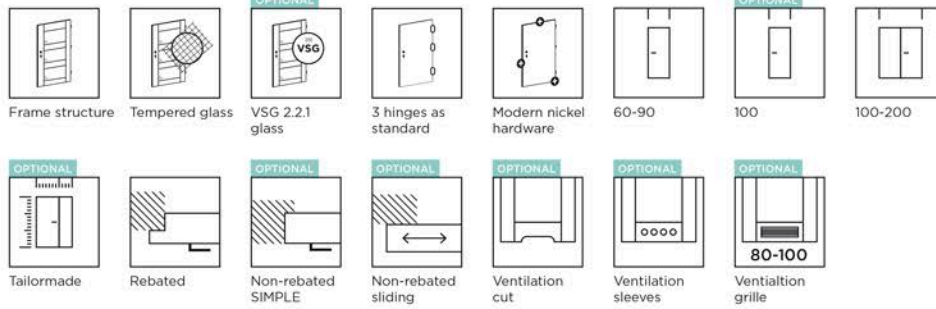

AVAILABLE WIDTH OPTIONS

- 60, 70, 80, 90, other sizes available for an additional charge

STRUCTURE

- Stable frame structure of MDF

FRAME VERSIONS

- fixed: timber & MDF
- adjustable: DIN, DUALE, ZOS

FITTINGS

- Satin tempered glass, thickness: 4 mm
- Optional: Satin VSG 2.2.1 glass, both sides smooth
- Mortice lock, key operated (can be replaced with a lock with blocking option, a Euro profile cylinder lock, or without a keyhole)
- Screw-fixing pivot hinges, 3pcs

PRESTIGE PU PRICING

Colour group	Price	
	Glass: Tempered satin	Glass: Satin VSG 2.2.1
CPL	£ 329,00	Ref. pricing to the left + additional cost in the table below
CLPL	£ 316,00	
FF	£ 254,50	

ALTERNATIVE GLAZING PRICES - SATIN VSG 2.2.1 GLASS

PU-01	PU-02	PU-03	PU-04	PU-05
-	£ 50,00	£ 16,50	£ 25,00	£ 25,00

Option to replace Satin VSG 2.2.1 glass with black VSG 2.2.1 glass for an additional cost, individually priced.

OPTIONS FOR AN ADDITIONAL CHARGE

NON-STANDARD WIDTH	ADDITIONAL COST
Width 100	£ 30,50
Width less than 60	£ 188,00
Non-standard width, door leaf with Satin deco, Lacomat or Satin VSG 2.2.1 glass	£ 92,00
NON-STANDARD HEIGHT	ADDITIONAL COST
Shorter, up to 60 mm	£ 26,00
Shorter, more than 60 mm (requires evaluation of manufacturability) door leaf with Satin deco, Lacomat or Satin VSG 2.2.1 glass	£ 96,50
Taller, up to 470 mm (requires evaluation of manufacturability) door leaf with Satin deco, Lacomat or Satin VSG 2.2.1 glass	£ 96,50
Extra hinge (required for all door leaves 110 mm to 470 mm taller)	£ 10,50
Extra hinge for the SIMPLE non-rebated system (required for all door leaves 110 mm to 470 mm taller)	£ 39,50
Repositioned lock (recommended for non-standard door height)	£ 30,50
Modification of model due to non-standard door height	£ 43,50
VENTILATION	ADDITIONAL COST
Ventilation cut	£ 13,50
Metal ventilation sleeves in nickel or bronze colour (piece)	£ 13,50
Plastic door grille, matt silver, fits door leaf sizes 80, 90 and 100	£ 26,00
OTHER	ADDITIONAL COST
SIMPLE non-rebated door leaf	£ 87,00
Sliding non-rebated door leaf (not applicable for PP colour group)	£ 21,50
Double door inactive leaf, width S2 420-609 mm	£ 188,00
Double door inactive leaf, width S2 610 mm, 710 mm, 810 mm, 910 mm	£ 39,50
Double door inactive leaf, width: S2 1010 mm	£ 70,00
Drop-down seal	£ 43,00

AVAILABLE COLOURS:

CPL GROUP

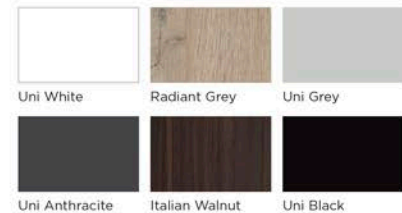

CLPL GROUP

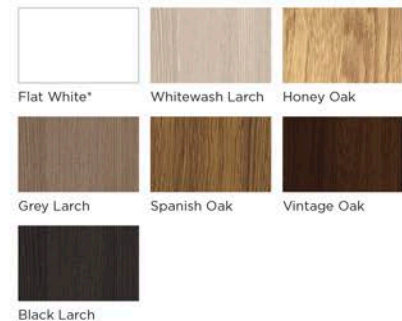

FF GROUP

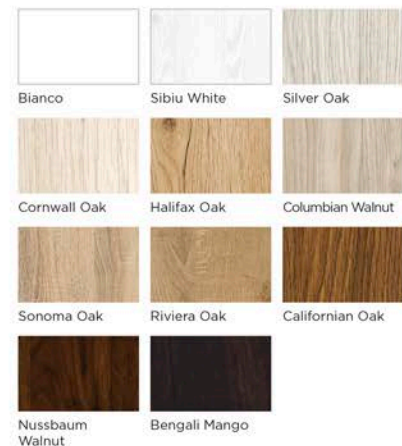

* While stocks last

NEW ARRIVAL

PRESTIGE PW-01, FF Bianco

PRESTIGE
PW

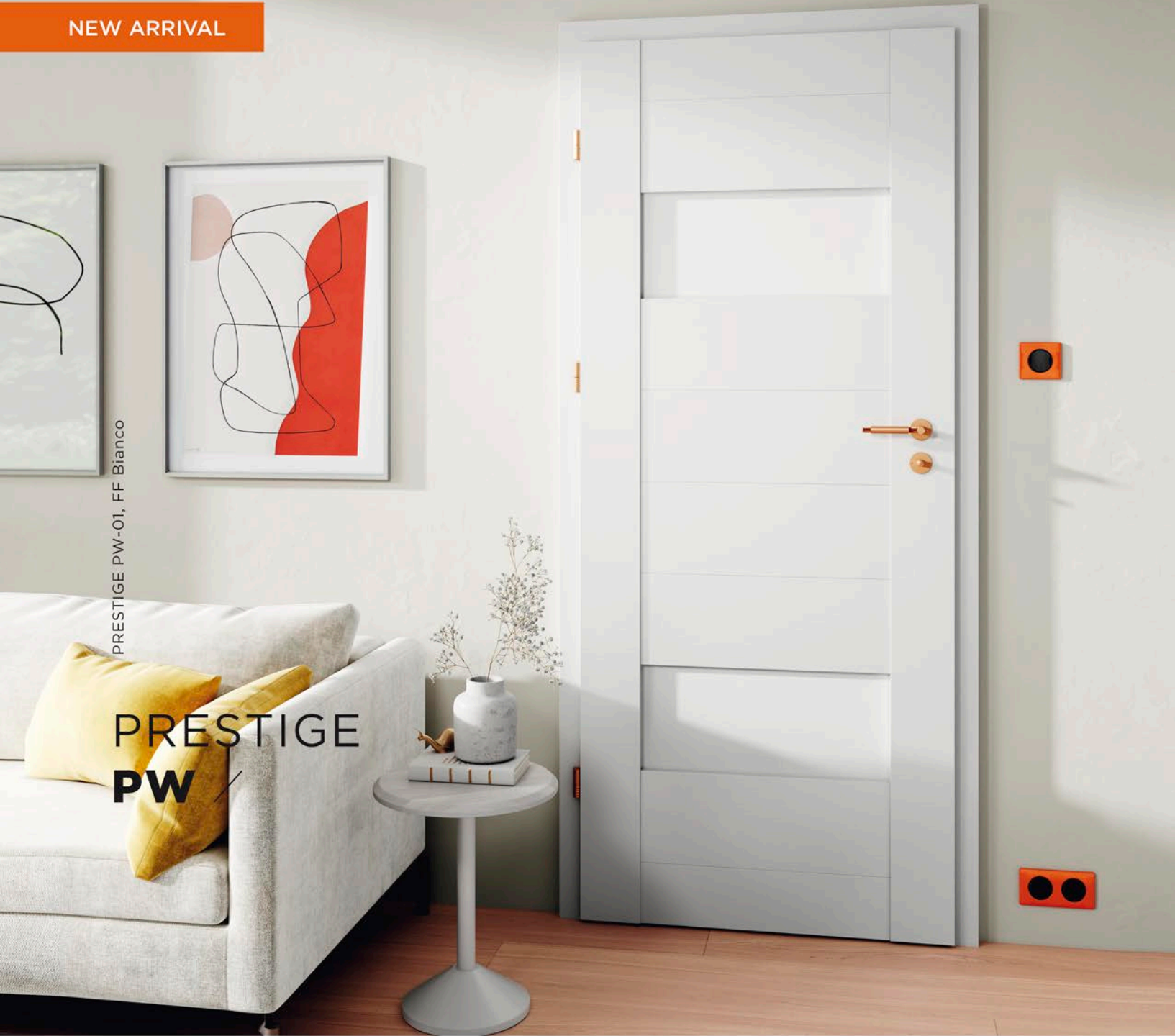

COLOUR: CPL Uni Black



PW-01

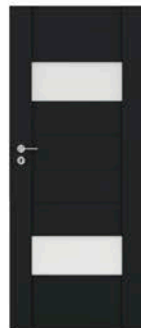

PW-02



PW-03

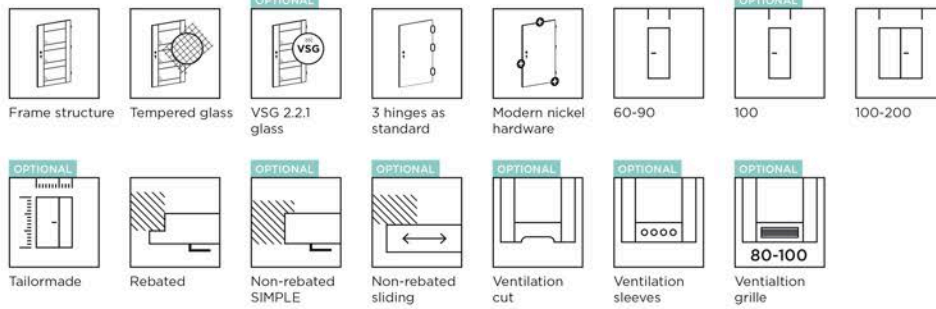

AVAILABLE WIDTH OPTIONS

- 60, 70, 80, 90, other sizes available for an additional charge

STRUCTURE

- Stable frame structure of MDF

FRAME VERSIONS

- fixed: timber & MDF
- adjustable: DIN, DUALE, ZOS

FITTINGS

- Satin tempered glass, thickness: 4 mm
- Optional: Satin VSG 2.2.1 glass, both sides smooth
- Mortice lock, key operated (can be replaced with a lock with blocking option, a Euro profile cylinder lock, or without a keyhole)
- Screw-fixing pivot hinges, 3pcs

PRESTIGE PW PRICING

Colour group	Price	
	Glass: Tempered satin	Glass: Satin VSG 2.2.1
CPL	£ 307,50	Ref. pricing to the left + additional cost in the table below
CLPL	£ 294,00	
FF	£ 241,00	

ALTERNATIVE GLAZING PRICES - SATIN VSG 2.2.1 GLASS

PW-01	PW-02	PW-03
-	£ 37,50	£ 18,50

Option to replace Satin VSG 2.2.1 glass with black VSG 2.2.1 glass for an additional cost, individually priced.

OPTIONS FOR AN ADDITIONAL CHARGE

NON-STANDARD WIDTH	ADDITIONAL COST
Width 100	£ 30,50
Width less than 60	£ 188,00
Non-standard width, door leaf with Satin deco, Lacomat or Satin VSG 2.2.1 glass	£ 92,00
NON-STANDARD HEIGHT	ADDITIONAL COST
Shorter, up to 60 mm	£ 26,00
Shorter, more than 60 mm (requires evaluation of manufacturability) door leaf with Satin deco, Lacomat or Satin VSG 2.2.1 glass	£ 96,50
Taller, up to 470 mm (requires evaluation of manufacturability) door leaf with Satin deco, Lacomat or Satin VSG 2.2.1 glass	£ 96,50
Extra hinge (required for all door leaves 110 mm to 470 mm taller)	£ 10,50
Extra hinge for the SIMPLE non-rebated system (required for all door leaves 110 mm to 470 mm taller)	£ 39,50
Repositioned lock (recommended for non-standard door height)	£ 30,50
Modification of model due to non-standard door height	£ 43,50
VENTILATION	ADDITIONAL COST
Ventilation cut	£ 13,50
Metal ventilation sleeves in nickel or bronze colour (piece)	£ 13,50
Plastic door grille, matt silver, fits door leaf sizes 80, 90 and 100	£ 26,00
OTHER	ADDITIONAL COST
SIMPLE non-rebated door leaf	£ 87,00
Sliding non-rebated door leaf (not applicable for PP colour group)	£ 21,50
Double door inactive leaf, width S2 420-609 mm	£ 188,00
Double door inactive leaf, width S2 610 mm, 710 mm, 810 mm, 910 mm	£ 39,50
Double door inactive leaf, width: S2 1010 mm	£ 70,00
Drop-down seal	£ 43,50

AVAILABLE COLOURS:

CPL GROUP      

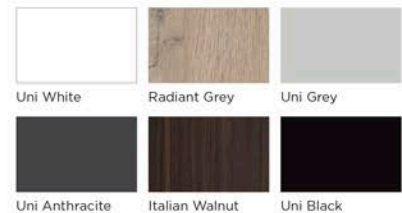

CLPL GROUP      

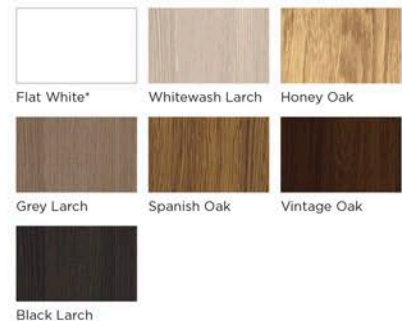

FF GROUP      

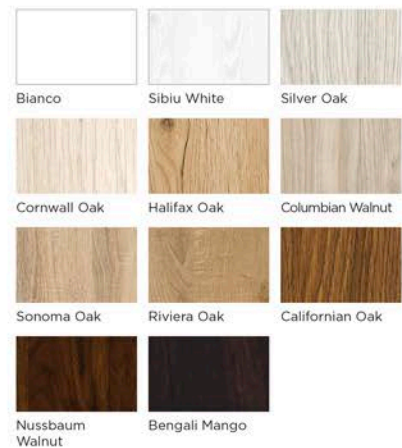

* While stocks last

NEW ARRIVAL

PRESTIGE PZ-05, FF Halifax Oak

PRESTIGE
PZ /



COLOUR CLPL Black Larch



PZ-01



PZ-02



PZ-03



PZ-04



PZ-05

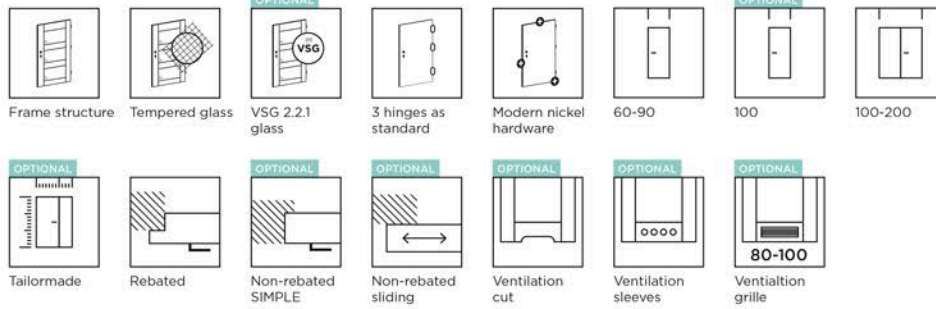

AVAILABLE WIDTH OPTIONS

- 60, 70, 80, 90, other sizes available for an additional charge

STRUCTURE

- Stable frame structure of MDF

FRAME VERSIONS

- fixed: timber & MDF
- adjustable: DIN, DUALE, ZOS

FITTINGS

- Satin tempered glass, thickness: 4 mm
- Optional: Satin VSG 2.2.1 glass, both sides smooth
- Mortice lock, key operated (can be replaced with a lock with blocking option, a Euro profile cylinder lock, or without a keyhole)
- Screw-fixing pivot hinges, 3pcs

PRESTIGE PZ PRICING

Colour group	Price	
	Glass: Tempered satin	Glass: Satin VSG 2.2.1
CPL	£ 307,50	Ref. pricing to the left + additional cost in the table below
CLPL	£ 294,00	
FF	£ 241,50	

ALTERNATIVE GLAZING PRICES - SATIN VSG 2.2.1 GLASS

PZ-01	PZ-02	PZ-03	PZ-04	PZ-05
-	£ 42,00	£ 21,00	£ 21,00	£ 21,00

Option to replace Satin VSG 2.2.1 glass with black VSG 2.2.1 glass for an additional cost, individually priced.

OPTIONS FOR AN ADDITIONAL CHARGE

NON-STANDARD WIDTH	ADDITIONAL COST
Width 100	£ 30,80
Width less than 60	£ 188,00
Non-standard width, door leaf with Satin deco, Lacomat or Satin VSG 2.2.1 glass	£ 92,00
NON-STANDARD HEIGHT	ADDITIONAL COST
Shorter, up to 60 mm	£ 26,00
Shorter, more than 60 mm (requires evaluation of manufacturability) door leaf with Satin deco, Lacomat or Satin VSG 2.2.1 glass	£ 96,50
Taller, up to 470 mm (requires evaluation of manufacturability) door leaf with Satin deco, Lacomat or Satin VSG 2.2.1 glass	£ 96,50
Extra hinge (required for all door leaves 110 mm to 470 mm taller)	£ 10,50
Extra hinge for the SIMPLE non-rebated system (required for all door leaves 110 mm to 470 mm taller)	£ 39,50
Repositioned lock (recommended for non-standard door height)	£ 30,50
Modification of model due to non-standard door height	£ 43,50
VENTILATION	ADDITIONAL COST
Ventilation cut	£ 13,50
Metal ventilation sleeves in nickel or bronze colour (piece)	£ 13,50
Plastic door grille, matt silver, fits door leaf sizes 80, 90 and 100	£ 26,00
OTHER	ADDITIONAL COST
SIMPLE non-rebated door leaf	£ 87,00
Sliding non-rebated door leaf (not applicable for PP colour group)	£ 21,50
Double door inactive leaf, width S2 420-609 mm	£ 188,00
Double door inactive leaf, width S2 610 mm, 710 mm, 810 mm, 910 mm	£ 39,50
Double door inactive leaf, width: S2 1010 mm	£ 70,00
Drop-down seal	£ 43,00

AVAILABLE COLOURS:

CPL GROUP

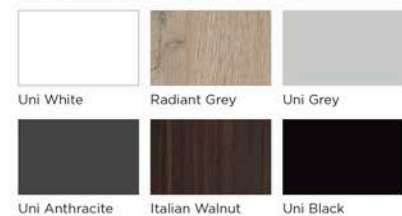

CLPL GROUP

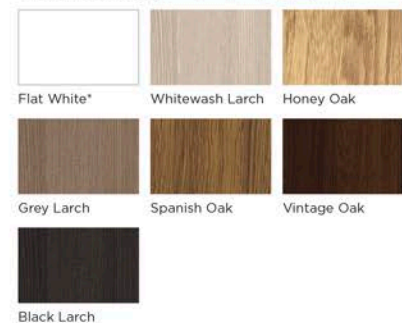

FF GROUP

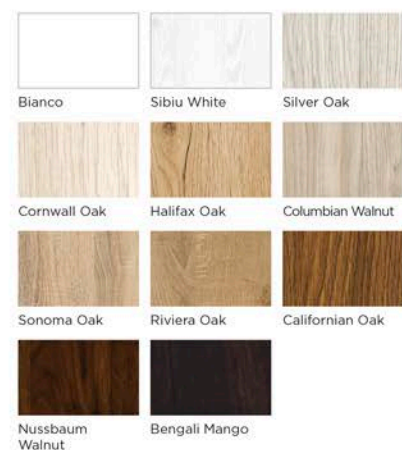

* While stocks last

BASIC PRESTON 01, FF Cornwall Oak

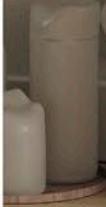

INTERNAL DOORS

/ **BASIC**

Ever-popular, robust, and highly functional. BASICdoors fit perfectly wherever they are installed, both at home and in the office. Available in a wide selection of colour and glazing options.

BASIC COLLECTION

BASIC DALLAS 4/4, FF Riviera Oak



AVAILABLE WIDTH OPTIONS

- 60, 70, 80, 90, other sizes available for an additional charge

STRUCTURE

- MDF stile & rail (timber option available for an additional charge)
- Infill: honeycomb stabilising core
- 3 mm HDF lining

FRAME VERSIONS

- Fixed: timber & MDF
- Adjustable: DIN, DUALE, ZOS
- Steel: fixed and slanted - large and adjustable

FIXTURES

- Glass: Satin Deco, thickness: 4 mm; PRESTON: Satin VSG 2.2.1 glass; ANATOLIA, CLASSIC & STANDARD: White Bark glass; MADRYT & MACADI-3: Satin Macadi glass; SAPPORO: Satin Sapporo glass
- Mortice lock, key operated (can be replaced with a lock with blocking option, a Euro profile cylinder lock, or without a keyhole)
- Nickel screw-fixing pivot hinges 2 pcs. (PRESTON & VEGAS: 3 pcs. for door leaf width 90)

BASIC COLLECTION

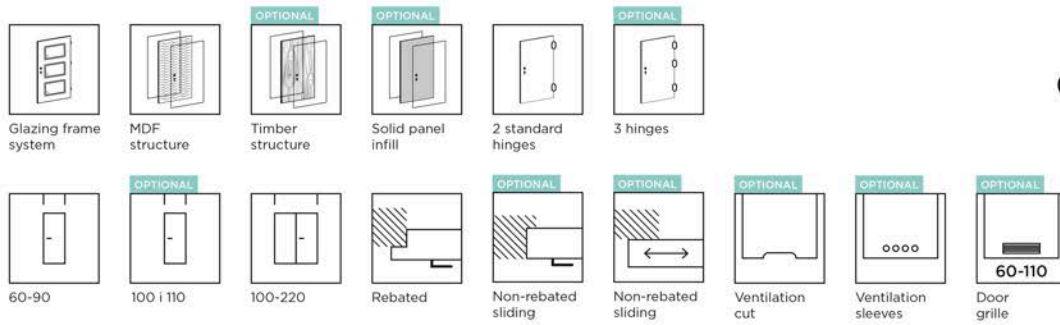

OPTIONAL

NON-STANDARD WIDTH

	ADDITIONAL COST
100 or 110 wide	£ 30,50
≤ 5 mm narrower	£ 30,50
> 5 mm narrower	£ 41,50
wider	£ 41,50

NON-STANDARD HEIGHT

	ADDITIONAL COST
Shorter, up to 60 mm	£ 21,50
> 60 mm shorter	£ 26,00
≤ 10 mm taller	£ 26,00
11 mm to 450 mm taller (not applicable to the LAK colour group)	£ 61,50
Extra hinge (required for these door leaves: 110 mm wide with a solid panel infill, and 110 mm to 450 mm tall)	£ 9,00
Extra hinge in the non-rebated SIMPLE system (necessary for door leaves longer by 110 mm to 450 mm)	£ 39,50
Repositioned lock (recommended for non-standard door height)	£ 30,50
Modification of model due to non-standard door height	£ 21,50

VENTILATION

	ADDITIONAL COST
Ventilation cut	£ 13,50
Plastic vent sleeves (set of)	£ 9,00
Ventilation sleeves with nickel or bronze covers (piece)	£ 13,50
Plastic door grille	£ 17,50
Plastic door grille, flat silver	£ 26,00
Stainless steel door grille	£ 105,00

OTHER

	ADDITIONAL COST
Timber stile & rail	£ 21,50
Solid panel infill (add cost for an extra hinget)	£ 52,50
2-coloured door	£ 50,00
CONTRAST door leaf	£ 24,00
SIMPLE non-rebated door leaf	£ 87,50
Sliding non-rebated door leaf	£ 21,50
MAGIC sliding system door leaf	£ 44,00
Reversible door leaf	£ 109,50
double door inactive leaf (requires additional cost for timber frame)	£ 39,50
double door inactive leaf, width S2 less than 610 mm (Standard 01 only; requires additional cost for timber frame)	£ 81,50
Door closer bolster (applies to door leaves with a honeycomb infill)	£ 19,50
20 mm rebate	£ 26,00
Pin lock with insert (the door frame price should include additional cost for adjustable mount)	£ 21,50
Top lock with insert	£ 17,50
Top pin lock with cylinder (the door frame price should include additional cost adjustable mount)	£ 17,50
Multi-point double-bolt lock (not available for door leaves with DIN, DUALE or ZOS frames)	£ 171,00
3D adjustable hinges (available as part of the door frame set for models fitted with 3D hinges)	£ 17,50
200° FOV spyhole	£ 44,00
Drop-down seal	£ 43,00
Preparation for electric striker installation in active door leaf	£ 35,00

AVAILABLE COLOURS:

FF GROUP



LAK GROUP



BASIC STANDARD 01



BASIC Standard 01, CPL Grey Uni

The BASIC STANDARD 01 model is available in an expanded colour range.



STANDARD 01
FF Silver Oak

PRICING

Colour group	Price
PVC	£ 232,50
CPL	£ 153,50
CLPL	£ 149,00
FF	£ 112,00
LAK	£ 92,50

The power of custom

AVAILABLE WIDTH OPTIONS

- 60, 70, 80, 90, other sizes available for an additional charge
- minimum total door leaf width: 244 mm
- maximum total door leaf width: 1144mm

STRUCTURE

- MDF stile & rail (timber option available for an additional charge)
- Infill: honeycomb stabilising core
- 3 mm HDF lining

FRAME VERSIONS

- Fixed: timber & MDF
- Adjustable: DIN, DUALE, ZOS
- Steel: fixed and slanted - large and adjustable

FIXTURES

- Mortice lock, key operated (can be replaced with a lock with blocking option, a Euro profile cylinder lock, or without a keyhole)
- screw-fixing pivot hinges 2 pcs. (3 pcs. for door leaf width 90)

AVAILABLE COLOURS:

PVC GROUP



CPL GROUP



CLPL GROUP



FF GROUP



LAK GROUP



THE POWER OF CUSTOM

The BASIC STANDARD 01 model is available in an expanded colour range.

NEW ARRIVAL

BASIC ASTORIA BLACK

BASIC ASTORIA BLACK, FF Bianco, Frame Uni Black, edging Uni Black

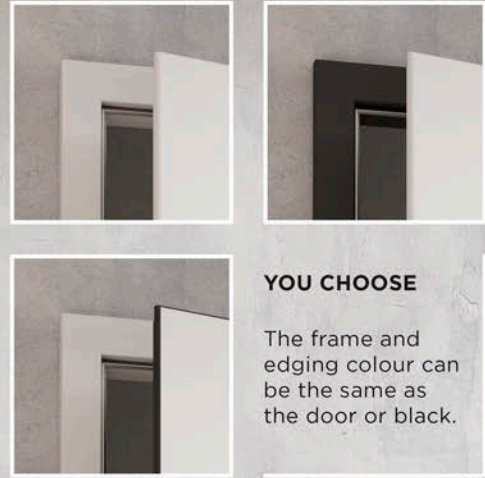

YOU CHOOSE

The frame and edging colour can be the same as the door or black.

EDGE FINISH TYPES

OPTIONAL



Standard rebated door



SOFT rebated door

OPTIONAL



Standard non-rebated door

OPTIONAL



SOFT non-rebated door

PRICING

Colour group	Glazing	Price
CPL	Lacobel Black	£ 276,50
CLPL	Lacobel Black	£ 259,00
FF	Lacobel Black	£ 246,00

The power of custom

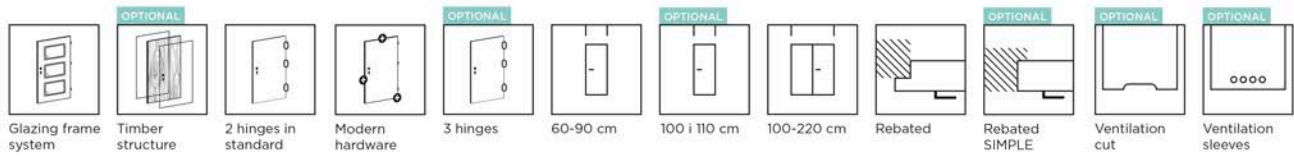

AVAILABLE WIDTH OPTIONS

- 60, 70, 80, 90, other sizes available for an additional charge

STRUCTURE

- MDF frame (timber frame available for additional charge)
- Infill: honeycomb stabilising core
- Surface from 6mm thick HDF panel
- Edge finish type: SOFT in black (can be changed to a standard finish-matching the outside of the door leaf or black, for no additional charge)

ACCESSORIES

- Black Lacobel glass
- Mortice lock, key operated (can be replaced with a lock with blocking option, a Euro profile cylinder lock, or without a keyhole)
- black hinges, screw pivot, 2 pcs. (3 pcs. for 90 door leaf) BRILLIANT hinges fitted as standard. Can be changed for another available colour, for no additional charge.

FRAME VERSIONS

- fixed: MDF
- adjustable: DIN

OPTIONAL

NON-STANDARD WIDTH	ADDITIONAL COST
100 or 110 wide	£ 30,50
≤ 5 mm narrower	£ 30,50
> 5 mm narrower	£ 41,50
Wider	£ 41,50
NON-STANDARD HEIGHT	ADDITIONAL COST
Shorter, up to 60 mm	£ 21,50
> 60 mm shorter	£ 26,50
≤ 10 mm taller	£ 26,50
11 mm to 450 mm taller	£ 61,50
Extra hinge (required for these door leaves: 110 wide, and 110 mm to 450 mm taller)	£ 9,00
Extra hinge in the non-rebated SIMPLE system (necessary for door leaves longer by 110 mm to 450 mm)	£ 39,50
Repositioned lock (recommended for non-standard door height)	£ 30,50
VENTILATION	ADDITIONAL COST
Ventilation cut	£ 13,50
Ventilation sleeves with nickel or bronze covers (piece)	£ 13,50
OTHER	ADDITIONAL COST
Timber frame	£ 21,50
SIMPLE non-rebated door leaf	£ 87,50
SIMPLE non-rebated door leaf	£ 21,50
Sliding non-rebated door leaf	£ 44,00
MAGIC sliding system door leaf	£ 109,50
Reversible door leaf	£ 39,50
double door inactive leaf (requires additional cost for timber frame)	£ 39,50
20 mm rebate	£ 26,50

AVAILABLE COLOURS:

CPL GROUP

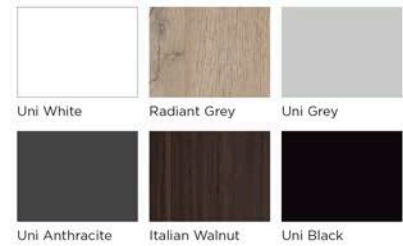

CLPL GROUP

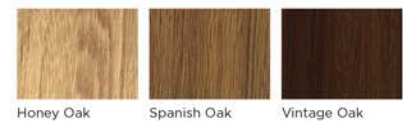

FF GROUP

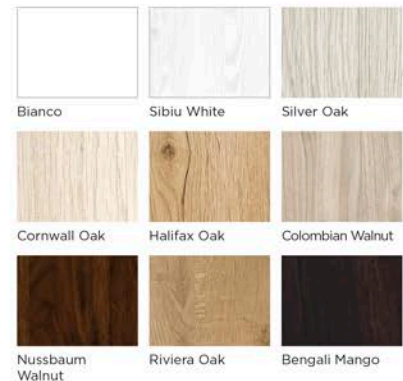

NEW ARRIVAL

BASIC ASTORIA GOLD

BASIC ASTORIA GOLD, FF Bengali Mango, frame Bengali Mango, edging Bengali Mango



EDGE FINISH TYPES

OPTIONAL



Standard rebated door



SOFT rebated door

OPTIONAL



Standard non-rebated door

OPTIONAL



SOFT non-rebated door

PRICING

Colour group	Glazing	Price
CPL	Lacobel Gold	£ 320,50
FF	Lacobel Gold	£ 276,50

The power of custom

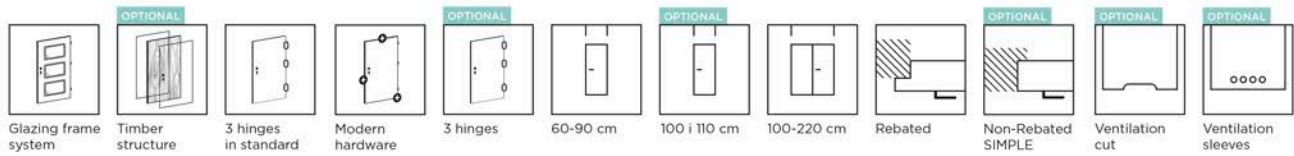

AVAILABLE WIDTH OPTIONS

- 60, 70, 80, 90, other sizes available for an additional charge

STRUCTURE

- MDF frame (timber frame available for additional charge)
- Infill: honeycomb stabilising core
- Surface from 6mm thick HDF panel
- Edge finish type: SOFT in black (can be changed to a standard finish matching the outside of the door leaf or black, for no additional charge)

ACCESSORIES

- Gold Lacobel glass
- Mortice lock, key operated (can be replaced with a lock with blocking option, a Euro profile cylinder lock, or without a keyhole)
- Gold hinges, screw pivot, 2 pcs. (3 pcs. for 90 door leaf) BRILLIANT hinges fitted as standard. Can be changed for another available colour, for no additional charge.

FRAME VERSIONS

- Fixed: timber & MDF
- Adjustable: DIN,

OPTIONAL

NON-STANDARD WIDTH	ADDITIONAL COST
100 or 110 wide	£ 30,50
≤ 5 mm narrower	£ 30,50
> 5 mm narrower	£ 41,50
wider	£ 41,45
NON-STANDARD HEIGHT	ADDITIONAL COST
Shorter, up to 60 mm	£ 21,50
> 60 mm shorter	£ 26,50
≤ 10 mm taller	£ 26,50
11 mm to 450 mm taller	£ 61,50
Extra hinge (required for these door leaves: 110 wide, and 110 mm to 450 mm taller)	£ 9,00
Extra hinge in the non-rebated SIMPLE system (necessary for door leaves longer by 110 mm to 450 mm)	£ 39,50
Repositioned lock (recommended for non-standard door height)	£ 30,50
VENTILATION	ADDITIONAL COST
Ventilation cut	£ 13,50
Ventilation sleeves with nickel or bronze covers (piece)	£ 13,50
OTHER	ADDITIONAL COST
Timber frame	£ 21,50
SIMPLE non-rebated door leaf	£ 87,50
SIMPLE non-rebated door leaf	£ 21,50
Sliding non-rebated door leaf	£ 44,00
MAGIC sliding system door leaf	£ 109,50
Reversible door leaf	£ 39,50
double door inactive leaf (requires additional cost for timber frame)	£ 39,50
20 mm rebate	£ 26,50

AVAILABLE COLOURS:

CPL GROUP



FF GROUP

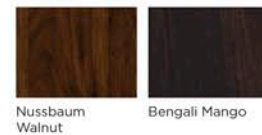

BASIC
PRESTON

Premium is
the new standard



PRICING

Colour group	Glazing	Price
CPL	Satin VSG 2.2.1	£ 395,00
CLPL	Satin VSG 2.2.1	£ 390,50
FF	Satin VSG 2.2.1	£ 351,00



Refined glazing strip

DIN PLUS CLASS EDGING

DIN PLUS CLASS edging is recommended with PRESTON doors, shaped to match the PRESTON glazing bead.





Solid panel infill



Satin VSG 2.2.1 glass



Modern Nickel hardware



Glazing frame system



Timber structure



3 hinges



60-90 cm

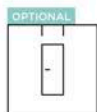

100 | 110 cm



100-220 cm



Rebated

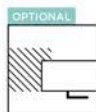

Non-Rebated SIMPLE

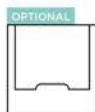

Ventilation cut

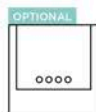

Ventilation sleeves

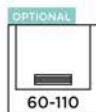

60-110 Door grille

AVAILABLE WIDTH OPTIONS

- 60, 70, 80, 90, other sizes available for an additional charge

STRUCTURE

- Timber stile & rail
- Solid panel infill
- 3 mm HDF lining

FIXTURES

- Satin VSG 2.2.1 glass, both sides smooth
- Mortice lock, key operated (can be replaced with a lock with blocking option, a Euro profile cylinder lock, or without a keyhole)
- Screw-fixing pivot hinges, 3pcs.

FRAME VERSIONS

- Fixed: timber & MDF
- Adjustable: DIN, DUALE, ZOS

OPTIONAL

NON-STANDARD WIDTH	ADDITIONAL COST
100 or 110 wide	£ 30,50
≤ 5 mm narrower	£ 30,50
> 5 mm narrower	£ 41,50
wider	£ 41,50
NON-STANDARD HEIGHT	ADDITIONAL COST
Shorter, up to 60 mm	£ 21,50
> 60 mm shorter	£ 26,50
≤ 10 mm taller	£ 26,50
11 mm to 450 mm taller	£ 61,50
Extra hinge (required for these door leaves: 110 wide, and 110 mm to 450 mm taller)	£ 9,00
Extra hinge in the non-rebated SIMPLE system (necessary for door leaves longer by 110 mm to 450 mm)	£ 39,50
Repositioned lock (recommended for non-standard door height)	£ 30,50
Modification of model due to non-standard door height	£ 21,50
VENTILATION	ADDITIONAL COST
Ventilation cut	£ 13,50
Ventilation sleeves with nickel or bronze covers (piece)	£ 13,50
Plastic door grille	£ 17,50
Plastic door grille, flat silver	£ 26,50
Stainless steel door grille	£ 105,00
OTHER	ADDITIONAL COST
CONTRAST door leaf	£ 24,00
SIMPLE non-rebated door leaf	£ 87,50
Sliding non-rebated door leaf	£ 21,50
MAGIC sliding system door leaf	£ 44,00
Reversible door leaf	£ 109,50
Double door inactive leaf	£ 39,50
20 mm rebate	£ 26,50

AVAILABLE COLOURS:

CPL GROUP



CLPL GROUP



FF GROUP



*While stocks last

BASIC SARA

Premium is
the new standard



SARA 01
PVC Super-flat Grey



01 02 03 04

PRICING

Colour group	Glazing	Price			
		Typ 01	Typ 02	Typ 03	Typ 04
PVC	Satin Deco, Chinchilla or Clear	£ 272,00	£ 303,00	£ 342,50	£ 369,00

ALTERNATIVE GLAZING PRICES

	Typ 01	Typ 02	Typ 03	Typ 04
Lacomat or Satin Lines	-	£ 17,50	£ 65,50	£ 96,50

AVAILABLE WIDTH OPTIONS

- 60, 70, 80, 90, other sizes available
- for an additional charge
- maximum overall door leaf width: 944 mm

STRUCTURE

- Timber stile
- Infill: honeycomb stabilizing core
- 3 mm HDF lining

FIXTURES

- Satin Deco glass, thickness: 4 mm
- Mortice lock, key operated (can be replaced with a lock with blocking option or a Euro profile cylinder lock)
- Screw-fixing pivot hinges, 2 pcs. (3 pcs. for door leaf width 90)

FRAME VERSIONS

- Fixed: timber & MDF
- Adjustable: DIN, DUALE, ZOS,

AVAILABLE COLOURS:

PVC GROUP



Textured White Super-flat Grey



Natural Grandson Oak

OPTIONAL

	ADDITIONAL COST
NON-STANDARD WIDTH	
≤ 5 mm narrower	£ 30,50
Narrower from 6 mm to 10 mm	£ 41,50
NON-STANDARD HEIGHT	
Shorter, up to 60 mm	£ 21,50
Shorter from 61 mm to 140 mm	£ 26,50
Wider up to 10 mm	£ 26,50
Extra hinge	£ 26,50
Repositioned lock (recommended for non-standard door height)	£ 30,50
VENTILATION	
Ventilation cut	£ 13,50
Plastic vent sleeves (set of)	£ 9,00
Ventilation sleeves with nickel or bronze covers (piece)	£ 13,50
Plastic door grille, flat silver	£ 17,50
Plastic door grille, matt silver	£ 26,50
Stainless steel door grille	£ 105,00
OTHER	
Solid panel infill	£ 109,50
CONTRAST door leaf	£ 24,00
SIMPLE non-rebated door leaf	£ 87,50
MAGIC sliding system door leaf	£ 44,00
Reversible door leaf	£ 109,50
Double door inactive leaf (minimal width for SARA: S2=610mm)	£ 39,50
Door closer bolster	£ 19,50
20 mm rebate	£ 26,50
Triple pin lock with insert (the door frame price should include additional cost for adjustable mount)	£ 21,50
Top lock with insert	£ 17,50
Top pin lock with cylinder (the door frame price should include additional cost for adjustable mount)	£ 17,50
Multi-point double-bolt lock (not available for door leaves with DIN, DUALE or ZOS frames)	£ 171,00
3D adjustable hinges (available as part of door frame set with 3D hinges)	£ 17,50
Panoramic spyhole 200°	£ 44,00
Drop-down seal	99,00 (121,77)



Premium is
the new standard

BASIC
ANATOLIA



ANATOLIA 03
PVC Textured White



01 02 03 04

PRICING

Colour group	Glazing	Price			
		Typ 01	Typ 02	Typ 03	Typ 04
PVC	Textured White, Chinchilla or Clear	£ 272,50	£ 303,00	£ 342,50	£ 369,00

ALTERNATIVE GLAZING PRICES

	Typ 01	Typ 02	Typ 03	Typ 04
Satin deco	-	£ 13,50	£ 41,50	£ 65,50
Lacomat or Satin lines	-	£ 17,50	£ 65,50	£ 96,50

AVAILABLE WIDTH OPTIONS

- 60, 70, 80, 90, other sizes available
- for an additional charge
- maximum overall door leaf width: 944 mm

STRUCTURE

- Timber stile
- Infill: honeycomb stabilizing core
- 3 mm HDF lining

FIXTURES

- Satin Deco glass, thickness: 4 mm
- Mortice lock, key operated (can be replaced with a lock with blocking option or a Euro profile cylinder lock)
- Screw-fixing pivot hinges, 2 pcs. (3 pcs. for door leaf width 90)

FRAME VERSIONS

- Fixed: timber & MDF
- Adjustable: DIN, DUALE, ZOS,

AVAILABLE COLOURS:

PVC GROUP



Textured White

Super-flat Grey



Natural Grandson Oak

OPTIONAL

NON-STANDARD WIDTH	ADDITIONAL COST
≤ 5 mm narrower	£ 30,50
narrower from 6 mm to 10 mm	£ 41,50
NON-STANDARD HEIGHT	
Shorter, up to 60 mm	£ 21,50
Shorter from 61 mm to 140 mm	£ 26,50
Wider up to 10 mm	£ 26,50
Extra hinge	£ 9,00
Repositioned lock (recommended for non-standard door height)	£ 30,50
VENTILATION	
Ventilation cut	£ 13,50
Plastic vent sleeves (set of)	£ 9,00
Ventilation sleeves with nickel or bronze covers (piece)	£ 13,50
Plastic door grille, flat silver	£ 17,50
Plastic door grille, matt silver	£ 26,50
Stainless steel door grille	£ 105,00
OTHER	
Solid panel infill	£ 109,50
CONTRAST door leaf	£ 24,00
SIMPLE non-rebated door leaf	£ 87,50
MAGIC sliding system door leaf	£ 44,00
Reversible door leaf	£ 109,50
Double door inactive leaf (minimal width for ANATOLIA: S2=610mm)	£ 39,50
Door closer bolster	£ 19,50
20 mm rebate	£ 26,50
Triple pin lock with insert (the door frame price should include additional cost for adjustable mount)	£ 21,50
Top lock with insert	£ 17,50
Top pin lock with cylinder (the door frame price should include additional cost for adjustable mount)	£ 17,50
Multi-point double-bolt lock (not available for door leaves with DIN, DUALE or ZOS frames)	£ 171,00
3D adjustable hinges (available as part of door frame set with 3D hinges)	£ 17,50
Panoramic spyhole 200°	£ 44,00
Drop-down seal	£ 43,00

BASIC MEDIOLAN

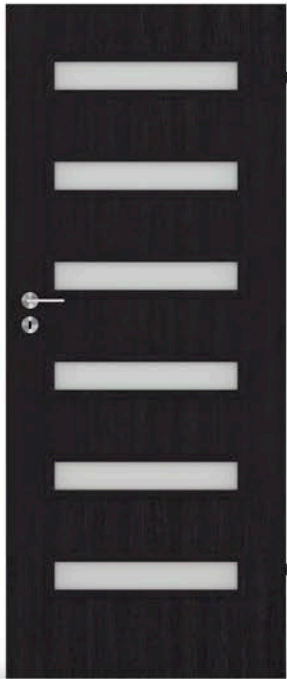

MEDIOLAN 6/6
FF Bengali Mango



0/6 2/6 4/6 6/6

PRICING

Colour group	Glazing	Price
FF	Satin Deco, Chinchilla or Clear	£ 197,50
LAK	Satin Deco, Chinchilla or Clear	£ 177,50

ALTERNATIVE GLAZING PRICES

	Type 2/6	Type 4/6	Type 6/6
Lacomat or Satin Lines	£ 15,00	£ 29,50	£ 44,50

BASIC PESARO

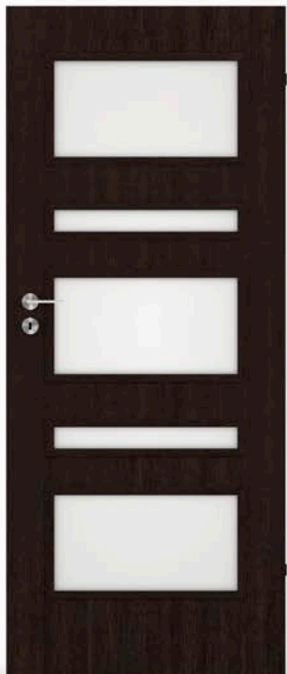

PESARO 5/5
FF Bengali Mango



0/5 1/5 2/5 v1 2/5 v2 3/5 v1 3/5 v2 4/5 5/5

PRICING

Colour group	Glazing	Price
FF	Satin Deco, Chinchilla or Clear	£ 228,00
LAK	Satin Deco, Chinchilla or Clear	£ 204,00

ALTERNATIVE GLAZING PRICES

	Type 1/5	Type 2/5 v1	Type 2/5 v2	Type 3/5 v1	Type 3/5 v2	Type 4/5	Type 5/5
Lacomat or Satin Lines	£ 21,50	£ 29,00	£ 14,50	£ 51,00	£ 65,00	£ 58,50	£ 80,50

BASIC MANHATTAN



MANHATTAN 4/4
FF Halifax Oak



0/4 1/4 2/4 3/4 4/4

PRICING

Colour group	Glazing	Price
FF	Satin Deco, Chinchilla or Clear	£ 219,50
LAK	Satin Deco, Chinchilla or Clear	£ 197,

ALTERNATIVE GLAZING PRICES

	Type 1/4	Type 2/4	Type 3/4	Type 4/4
Lacomat or Satin Lines	£ 21,50	£ 43,50	£65,50	£ 87,50

BASIC TRIVENTO



TRIVENTO 3/3
LAK Whitewash Oak



0/3 1/3 v1 1/3 v2 2/3 v1 2/3 v2 3/3

PRICING

Colour group	Glazing	Price
FF	Satin Deco, Chinchilla or Clear	£ 224,00
LAK	Satin Deco, Chinchilla or Clear	£ 202,00

ALTERNATIVE GLAZING PRICES

	Type 1/3 v1	Type 1/3 v2	Type 2/3 v1	Type 2/3 v2	Type 3/3
Lacomat or Satin Lines	£ 39,50	£ 15,50	£ 54,50	£ 79,00	£ 94,00

BASIC DALLAS



DALLAS 4/4
LAK Whitewash Oak



0/4 1/4 2/4 3/4 4/4

PRICING

Colour group	Glazing	Price
FF	Satin Deco, Chinchilla or Clear	£ 158,00
LAK	Satin Deco, Chinchilla or Clear	£ 133,50

ALTERNATIVE GLAZING PRICES

	Type 1/4	Type 2/4	Type 3/4	Type 4/4
Lacomat or Satin Lines	£ 8,00	£ 14,00	£ 21,00	£ 28,00

BASIC PALERMO



PALERMO 8/8
FF Nussbaum Walnut



0/8 2/8 4/8 6/8 8/8

PRICING

Colour group	Glazing	Price
FF	Satin Deco, Chinchilla or Clear	£ 224,00
LAK	Satin Deco, Chinchilla or Clear	£ 202,0

ALTERNATIVE GLAZING PRICES

	Type 2/8	Type 4/8	Type 6/8	Type 8/8
Lacomat or Satin Lines	£ 14,50	£ 29,50	£ 44,50	£ 59,00

BASIC MADRID

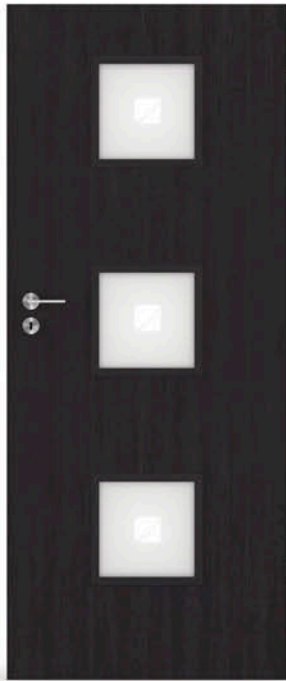

MADRYT 3/3
FF Bengali Mango

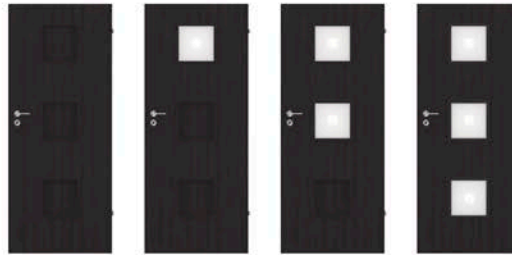

0/3 1/3 2/3 3/3

PRICING

Colour group	Glazing	Price
FF	Satin Deco, Chinchilla or Clear	£ 171,00
LAK	Satin Deco, Chinchilla or Clear	£ 149,00

ALTERNATIVE GLAZING PRICES

	Type 1/3	Type 2/3	Type 3/3
Lacomat or Satin Lines	£ 12,50	£ 24,50	£ 36,50

BASIC MACADI-3

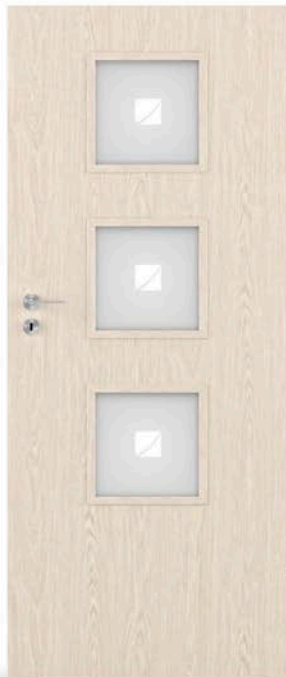

MACADI-3 3/3
FF Cornwall Oak

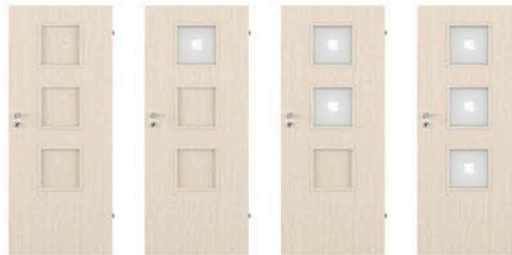

0/3 1/3 2/3 3/3

PRICING

Colour group	Glazing	Price
FF	Satin Macadi, Satin Deco, Chinchilla or Clear	£ 171,00
LAK	Satin Macadi, Satin Deco, Chinchilla or Clear	£ 149,00

ALTERNATIVE GLAZING PRICES

	Type 1/3	Type 2/3	Type 3/3
Lacomat or Satin Lines	£ 12,50	£ 24,50	£ 36,50

BASIC SAPPORO



SAPPORO 4/4
FF Bavarian Alder



0/4 1/4 2/4 3/4 4/4

PRICING

Colour group	Glazing	Price
FF	Satin Sapporo, Satin Deco, Chinchilla or Clear	£ 184,50
LAK	Satin Sapporo, Satin Deco, Chinchilla or Clear	£ 160,00

ALTERNATIVE GLAZING PRICES

	Type 1/4	Type 2/4	Type 3/4	Type 4/4
Lacomat or Satin Lines	£ 10,00	£ 19,50	£ 29,00	£ 38,50

BASIC CARSON

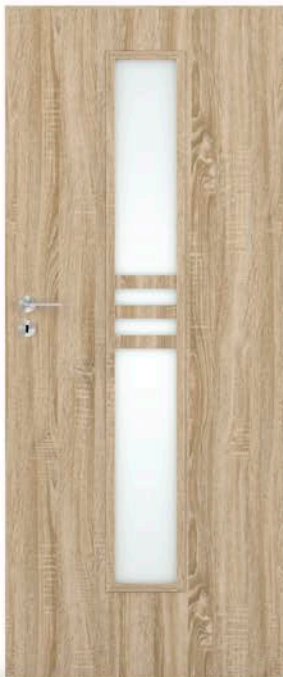

CARSON 04
LAK Whitewash Oak



01 02 03 04 05 06 07

PRICING

Colour group	Glazing	Price	
		Type 01, 02, 03, 04, 05	Type 06, 07
FF	Satin Deco, Chinchilla or Clear	£ 166,50	£ 235,0
LAK	Satin Deco, Chinchilla or Clear	£ 144,50	£ 210,50

ALTERNATIVE GLAZING PRICES

	Type 03	Type 04, 05	Type 06, 07
Lacomat or Satin Lines	£ 13,50	£ 39,50	£ 96,50

BASIC PANAMA



PANAMA 3/3
LAK Silver Oak



0/3 1/3 v1 1/3 v2 2/3 v1 2/3 v2 3/3

PRICING

Colour group	Glazing	Price
FF	Satin Deco, Chinchilla or Clear	£ 144,50
LAK	Satin Deco, Chinchilla or Clear	£ 123,00

ALTERNATIVE GLAZING PRICES

	Type 1/3 v1	Type 1/3 v2	Type 2/3 v1	Type 2/3 v2	Type 3/3
Lacomat or Satin Lines	£ 7,50	£ 3,00	£ 9,50	£ 15,00	£ 17,50

BASIC FLAVIO

NEW ARRIVAL



FLAVIO 03
FF Cornwall Oak



01 02 03

PRICING

Colour group	Glazing	Price
FF	Satin Deco, Chinchilla or Clear	£ 158,00
LAK	Satin Deco, Chinchilla or Clear	£ 136,00

ALTERNATIVE GLAZING PRICES

	Type 01	Type 01
Lacomat or Satin Lines	£ 9,00	£ 19,50

BASIC PORTO



PORTO 6/6
FF Riviera Oak



0/6 2/6v1 2/6v2 4/6 6/6

PRICING

Colour group	Glazing	Price
FF	Satin Deco, Chinchilla or Clear	£ 199,50
LAK	Satin Deco, Chinchilla or Clear	£ 175,50

ALTERNATIVE GLAZING PRICES

	Type 2/6v1, 2/6v2	Type 4/6	Type 6/6
Lacomat or Satin Lines	£ 14,50	£ 29,50	£ 44,50

BASIC RIMINI



RIMINI 5/5
LAK Walnut



0/5 1/5 2/5 3/5 4/5 5/5

PRICING

Colour group	Glazing	Price
FF	Satin Deco, Chinchilla or Clear	£ 224,00
LAK	Satin Deco, Chinchilla or Clear	£ 202,00

ALTERNATIVE GLAZING PRICES

	Type 1/5	Type 2/5	Type 3/5	Type 4/5	Type 5/5
Lacomat or Satin Lines	£ 17,50	£ 35,00	£ 52,50	£ 70,00	£ 87,50

BASIC SOFIA



SOFIA 3/3
LAK Silver Oak



0/3 1/3 2/3 3/3

PRICING

Colour group	Glazing	Price
FF	Satin Deco, Chinchilla or Clear	£ 224,00
LAK	Satin Deco, Chinchilla or Clear	£ 199,50

ALTERNATIVE GLAZING PRICES

	Type 1/3	Type 2/3	Type 3/3
Lacomat or Satin Lines	£ 31,50	£ 63,00	£ 94,50

BASIC LIMA



LIMA 3/3
LAK Silver Oak



0/3 1/3 3/3 1/1 2/2

PRICING

Colour group	Glazing	Price
FF	Satin Deco, Chinchilla or Clear	£ 155,50
LAK	Satin Deco, Chinchilla or Clear	£ 131,50

ALTERNATIVE GLAZING PRICES

	Type 1/3	Type 3/3	Type 1/1	Type 2/2
Lacomat or Satin Lines	£ 7,00	£ 21,00	£ 7,00	£ 14,00

BASIC BOSTON



BOSTON 05
LAK Nordic Elm



01 02 03 04 05 06

PRICING

Colour group	Glazing	Price
FF	Satin Deco, Chinchilla or Clear	£ 197,50
LAK	Satin Deco, Chinchilla or Clear	£ 175,50

ALTERNATIVE GLAZING PRICES

	Type 03	Type 04	Type 05	Type 06
Lacomat or Satin Lines	£ 12,50	£ 24,50	£ 28,50	£ 57,50

BASIC VERONA



VERONA 4/4
LAK Whitewash Oak



0/4 1/4 2/4 3/4 4/4

PRICING

Colour group	Glazing	Price
FF	Satin Deco, Chinchilla or Clear	£ 175,50
LAK	Satin Deco, Chinchilla or Clear	£ 153,50

ALTERNATIVE GLAZING PRICES

	Type 1/4	Type 2/4	Type 3/4	Type 4/4
Lacomat or Satin Lines	£ 8,00	£ 15,00	£ 22,50	£ 29,50

BASIC VEDI



VEDI 5/5
LAK Silver Oak



0/5 1/5 2/5 3/5 4/5 5/5

PRICING

Colour group	Glazing	Price
FF	Satin Deco, Chinchilla or Clear	£ 162,50
LAK	Satin Deco, Chinchilla or Clear	£ 140,50

ALTERNATIVE GLAZING PRICES

	Type 1/5	Type 2/5	Type 3/5	Type 4/5	Type 5/5
Lacomat or Satin Lines	£ 5,00	£ 10,00	£ 14,50	£ 19,50	£ 24,00

BASIC VENTE



VENTE 4/4
LAK Adler



0/4 1/4 2/4 3/4 4/4

PRICING

Colour group	Glazing	Price
FF	Satin Deco, Chinchilla or Clear	£ 206,00
LAK	Satin Deco, Chinchilla or Clear	£ 180,00

ALTERNATIVE GLAZING PRICES

	Type 1/4	Type 2/4	Type 3/4	Type 4/4
Lacomat or Satin Lines	£ 17,50	£ 35,50	£ 52,50	£ 70,00

BASIC VENICE

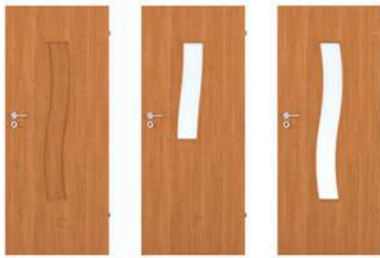

01
02
03
FF Bavarian Alder

PRICING

Colour group	Glazing	Price
FF	Satin Deco, Chinchilla or Clear	£ 208,50
LAK	Satin Deco, Chinchilla or Clear	£ 186,50

ALTERNATIVE GLAZING PRICES

	Type 02	Type 03
Lacomat or Satin Lines	£ 21,50	£ 41,50

BASIC LYON



01
02
03
04
FF Bavarian Alder

PRICING

Colour group	Glazing	Price
FF	Satin Deco, Chinchilla or Clear	£ 267,50
LAK	Satin Deco, Chinchilla or Clear	£ 243,50

ALTERNATIVE GLAZING PRICES

	Type 02	Type 03	Type 04
Lacomat or Satin Lines	£ 28,50	£ 59,00	£ 85,50

BASIC VIGO



01
02
03
LAK Walnut

PRICING

Colour group	Glazing	Price
FF	Satin Deco, Chinchilla or Clear	£ 228,00
LAK	Satin Deco, Chinchilla or Clear	£ 206,00

ALTERNATIVE GLAZING PRICES

	Type 02	Type 03
Lacomat or Satin Lines	£ 21,50	£ 65,50

BASIC CLASSIC

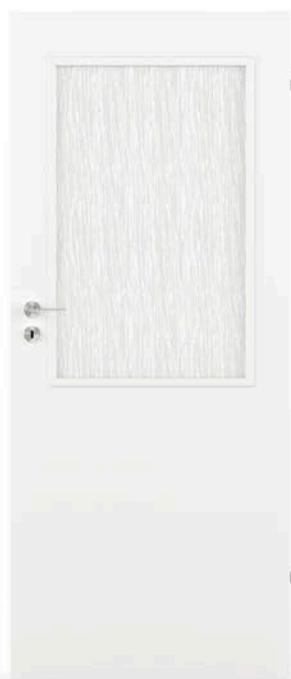

CLASSIC 03
LAK White



01 02 03

PRICING

Colour group	Glazing	Price	
		Type 01, 03	Type 02
FF	Satin Deco, Chinchilla or Clear	£ 173,50	£ 144,50
LAK	Satin Deco, Chinchilla or Clear	£ 151,50	£ 123,00

ALTERNATIVE GLAZING PRICES

	Type 02	Type 03
Satin deco	£ 13,50	£ 41,50
Lacomat or Satin Lines	£ 17,50	£ 65,50

BASIC STANDARD



STANDARD 03
LAK White



02 03 04

PRICING

Colour group	Glazing	Price		
		Type 02	Type 03	Type 04
FF	Satin Deco, Chinchilla or Clear	£ 142,50	£ 175,50	£ 208,50
LAK	Satin Deco, Chinchilla or Clear	£ 120,50	£ 155,50	£ 186,50

ALTERNATIVE GLAZING PRICES

	Type 02	Type 03	Type 04
Satin deco	£ 13,50	£ 41,50	£ 65,50
Lacomat or Satin Lines	£ 17,50	£ 65,50	£ 96,50



STANDARD SOLID PLUS

The SOLID PLUS products are intended as internal front doors. The complete product features a 46 mm thick door leaf, fixed 90 mm thick frame, steel sill, spyhole, and set of door handles.

STANDARD SOLID PLUS, PVC Natural Grandson Oak



AVAILABLE WIDTH OPTIONS

- 80, 90, other sizes available for an additional charge

STRUCTURE

- Timber stile & rail
- Solid panel infill
- 6 mm HDF lining

FRAME

- fixed timber 44 mm x 90 mm

FIXTURES

Door leaf:

- Mortice bolt lock with a Euro profile cylinder, 2 pcs.
- 3D adjustable pivot hinges, 3pcs.
- 200° FOV spyhole
- Hinge bolts
- Weatherstrip

Fixed timber frame:

- Adjustable strikers, 2 pcs.
- 3D adjustable pivot hinges, 3pcs.
- Weatherstrip
- Installation hardware

Accessories:

- Stainless steel sill w/ weatherstrip
- Lambda door handle with INOX coloured top plate

STANDARD SOLID PLUS

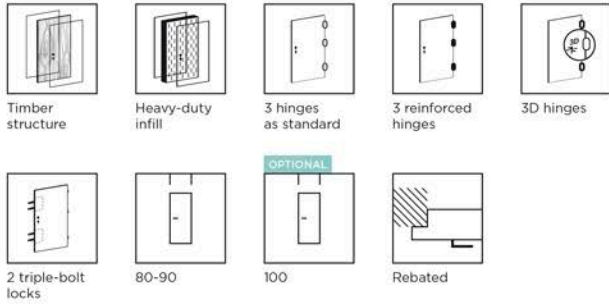

PRICING

Colour group	Price
PVC	£ 746,50
CPL	£ 672,00
CLPL	£ 658,50
FF	£ 615,00
LAK	£ 571,00

OPTIONAL ACCESSORIES - DOOR LEAF

NON-STANDARD WIDTH	ADDITIONAL COST
Width: 100	£ 30,50
≤ 5 mm narrower	£ 30,50
> 5 mm narrower	£ 41,50
wider	£ 41,50

NON-STANDARD HEIGHT	ADDITIONAL COST
Shorter, up to 60 mm	£ 21,50
> 60 mm shorter	£ 26,50
≤ 10 mm taller	£ 26,50
Extra hinge (required for door leaf width 100)	£ 9,00
Repositioned lock (recommended for non-standard door height)	£ 30,50

OTHER	ADDITIONAL COST
CONTRAST door leaf	£ 24,00
Multi-point double-bolt lock	£ 171,00
Raw timber sill w/weatherstrip	£ 39,50
Drop-down seal	£ 43,00

OPTIONAL ACCESSORIES - TIMBER FRAME

Non-standard width	£ 26,50
Non-standard height: ≤ 10 mm taller	£ 26,50
Non-standard height: lower height	£ 21,50
Repositioned striker (recommended for non-standard door frame height)	£ 30,50
Extra hinge (necessary for 100 door frame)	£ 9,00
Double-bolt lock striker	£ 39,50

COLOURS:

PVC GROUP



CPL GROUP

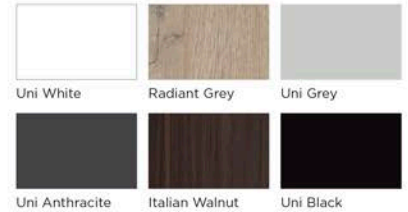

CLPL GROUP



FF GROUP

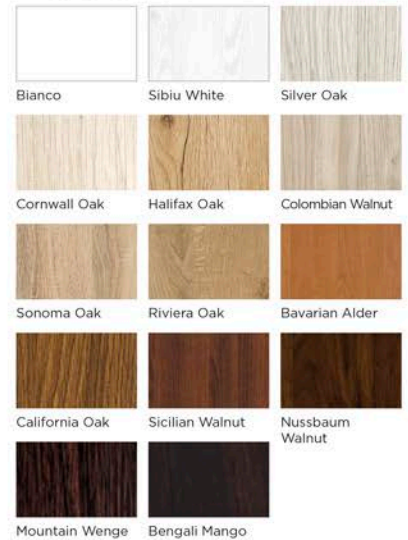

LAK GROUP



VEGAS

SOLID PLUS

The SOLID PLUS products are intended as internal front doors. The complete product features a 46 mm thick door leaf, fixed 90 mm thick frame, steel sill, spyhole, and set of door handles.

VEGAS SOLID PLUS 13. PVC Super-flat Grey



03



05



06



07



08



09



10



11



12



13

VEGAS SOLID PLUS

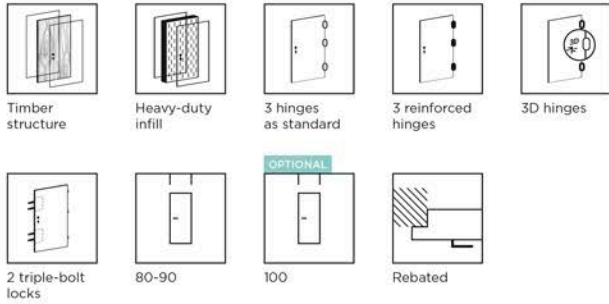

AVAILABLE WIDTH OPTIONS

- 80, 90, other sizes available for an additional charge

STRUCTURE

- Timber stile & rail
- Solid panel infill
- 6 mm HDF lining

FRAME

- fixed timber 44 mm x 90 mm

FIXTURES

Door leaf:

- Mortice bolt lock with a Euro profile cylinder, 2 pcs.
- 3D adjustable pivot hinges, 3pcs.
- 200° FOV spyhole
- Hinge bolts
- Weatherstrip

Fixed timber frame:

- Adjustable strikers, 2 pcs.
- 3D adjustable pivot hinges, 3pcs.
- Weatherstrip
- Installation hardware

Accessories:

- Stainless steel sill w/weatherstrip
- Lambda door handle with INOX coloured top plate

COLOURS: PVC GROUP



PRICING

Colour Group	Price
PVC	£ 812,50

OPTIONAL ACCESSORIES - DOOR LEAF

NON-STANDARD WIDTH	ADDITIONAL COST
Width: 100	£ 26,50
≤ 5 mm narrower	£ 26,50
> 5 mm narrower	£ 41,50
wider	£ 41,50
NON-STANDARD HEIGHT	ADDITIONAL COST
Shorter, up to 60 mm	£ 21,50
> 60 mm shorter	£ 26,50
≤ 10 mm taller	£ 26,50
Extra hinge (required for door leaf width 100)	£ 9,00
Repositioned lock (recommended for non-standard door height)	£ 26,50
OTHER	ADDITIONAL COST
CONTRAST door leaf	£ 24,00
Multi-point double-bolt lock	£ 171,00
Raw timber sill w/weatherstrip	£ 39,50
Drop-down seal	£ 43,00

OPTIONAL ACCESSORIES - TIMBER FRAME

Non-standard width	£ 26,50
Non-standard height: ≤ 10 mm taller	£ 26,50
Non-standard height: lower height	£ 21,50
Repositioned striker (recommended for non-standard door frame height)	£ 26,50
Extra hinge (necessary for 100 door frame)	£ 9,00
Double-bolt lock striker	£ 39,50

SOUNDPROOF

SOUND-PROOF FRONT DOOR, CLPL Vintage Oak

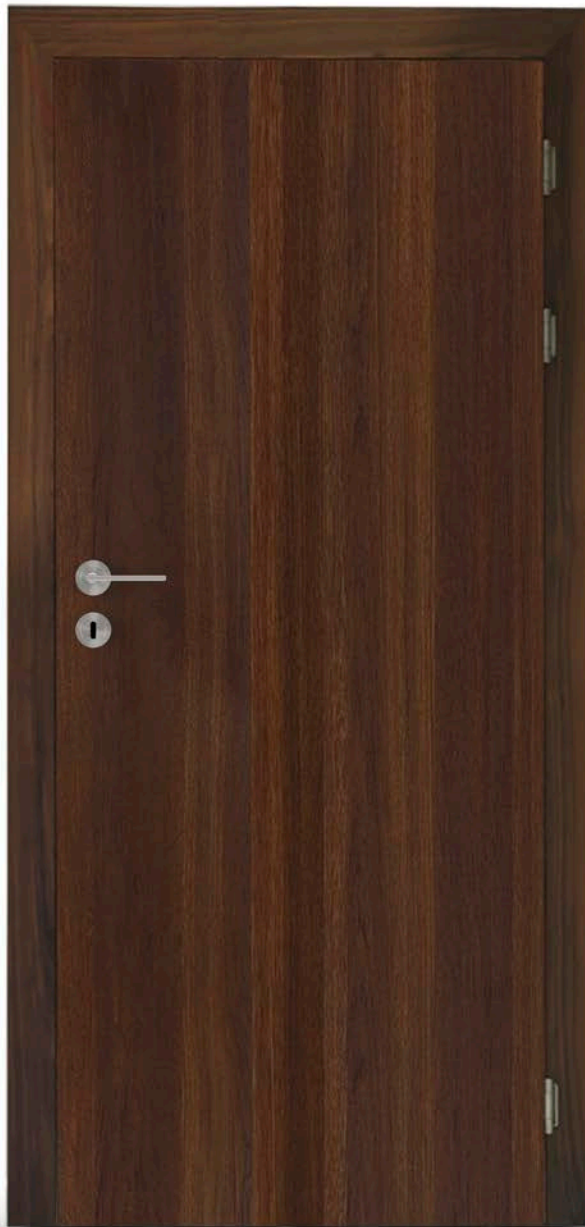

Remember to purchase matching accessories. Explore the front door handle range.

These technical access doors are intended as internal entrance doors. The single-door and double-door versions provide noise insulation of 32 dB and 27 dB, respectively. The door thickness is 50 mm.

SIZE TABLE FOR STANDARD DIMENSIONS OF INTERNAL FRONT DOORS

Width	Width in frame clearance, mm	Height in frame clearance, mm	Overall frame width, mm	Overall frame height, mm	Recommended installation opening size, mm (W x H)	
Single door	80	801	2017	911	2071	930 x 2081
	90	901	2017	1011	2071	1030 x 2081
	100	1001	2017	1111	2071	1130 x 2081
	110	1101	2017	1211	2071	1230 x 2081

SOUNDPROOF

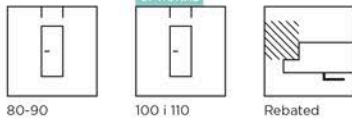
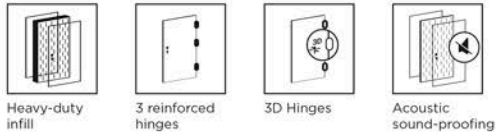

AVAILABLE WIDTH OPTIONS

- 80, 90, other sizes available for an additional charge

STRUCTURE

Door leaf:

- Three-ply chipboard, fire rated, w/o rails, with glued wooden trim around the circumference
- 3 mm HDF lining

Door frame:

- Fixed, timber: 54 mm x 90 mm

FIXTURES

Door leaf:

- Profile cylinder lock
- Adjustable pivot hinges, 3 pcs.
- Drop-down seal

Door frame:

- Strike
- Adjustable pivot hinges, 3 pcs.
- Sound-proofing seal
- Installation hardware

Accessories:

- OVAL 1701 lock with lower insert label

PRICING

Colour group	Price	
	Single door (32 dB)	Double door (27 dB)
PVC	£ 1 080,50	£ 1 985,50
CPL	£ 1 027,50	£ 1 888,50
CLPL	£ 1 014,50	£ 1 866,50
FF	£ 970,50	£ 1 783,50

OPTIONAL

NON-STANDARD WIDTH	ADDITIONAL COST
100 or 110 wide	50%
≤ 5 mm narrower	£ 57,00
> 5 mm narrower	£ 68,00
wider	£ 68,00

NON-STANDARD HEIGHT	ADDITIONAL COST
Shorter, up to 60 mm	£ 44,00
> 60 mm shorter	£ 48,00
≤ 10 mm taller	£ 52,50
11 mm to 300 mm taller	50%
Extra hinge (required for all door 100 and 110 wide and 110 mm to 300 mm taller)	£ 48,00
Repositioned striker and lock (recommended for non-standard door height)	£ 61,50

OTHER	ADDITIONAL COST
Fire-rated door grille, 300 mm x 150 mm	£ 373,00
Top lock w/cylinder	£ 44,00
200° FOV spyhole	£ 44,00
Door ready for customer-installed lock	£ 79,00

DOOR CLOSERS AND ELECTRIC STRIKES	
Overhead GROOM 200 door closer with guiderail, silver	£ 114,00
Overhead GROOM 200 door closer for double doors, silver	£ 434,50
Mounted ITS96 door closer	£ 351,00
Mounted ITS96 door closer for double doors	£ 1 142,00
PPOZ electric strike	£ 527,00

COLOURS:

PVC GROUP



CPL GROUP

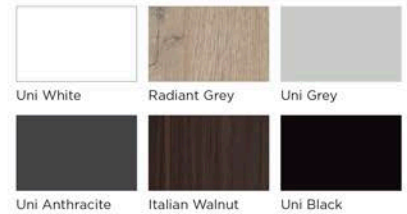

CLPL GROUP



FF GROUP

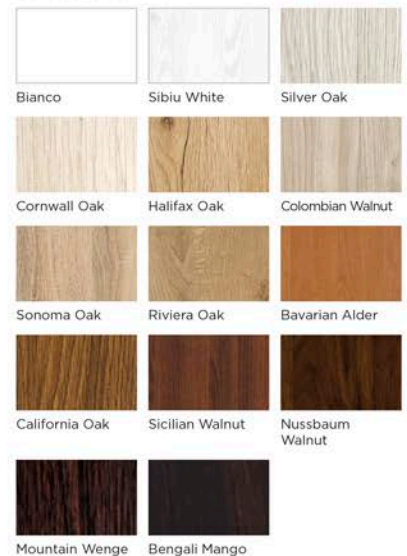

EI30 FIRE RATED & SOUNDPROOF

FRONT INTERNAL EI30 FIRE-RATED
& SOUND-PROOF DOOR, CLPL Vintage Oak



Remember to purchase matching accessories. Explore the front door handle range.

These technical fire rated access doors are intended as internal entrance doors. The single-door and double-door versions provide noise insulation of 32 dB and 27 dB, respectively. The door leaf thickness is 50 mm. The technical fire rated access doors can be installed in masonry walls (min. thickness: 115 mm), (reinforced) concrete walls (min. thickness: 100 mm), cellular concrete walls (min. thickness: 150 mm) or EI30 fire rated drywall panel walls (min. thickness: 100 mm).

SIZE TABLE FOR STANDARD DIMENSIONS OF INTERNAL FRONT DOORS

Width		Width in frame clearance, mm	Height in frame clearance, mm	Overall frame width, mm	Overall frame height, mm	Recommended installation opening size, mm (W x H)
Single door	80	801	2017	911	2071	930 x 2081
	90	901	2017	1011	2071	1030 x 2081
	100	1001	2017	1111	2071	1130 x 2081
	110	1101	2017	1211	2071	1230 x 2081

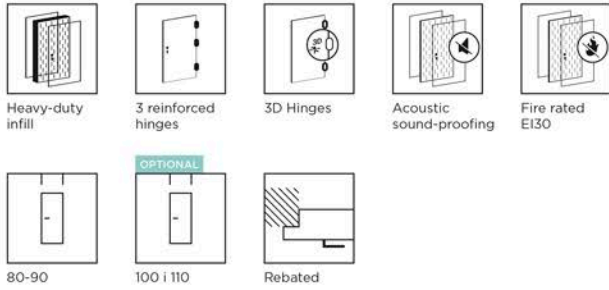

AVAILABLE WIDTH OPTIONS

- 80, 90, other sizes available for an additional charge

STRUCTURE

Door leaf:

- Three-ply chipboard, fire rated, w/o rails, with glued wooden trim around the circumference
- 3 mm HDF lining

Door frame:

- Fixed, timber: 54 mm x 90 mm

FIXTURES

Door leaf:

- Mortice lock with a Euro profile cylinder
- Adjustable pintle hinges, 3 pcs.
- Drop-down seal

Door frame:

- Striker
- Adjustable pintle hinges, 3 pcs.
- Soundproofing gasket
- Installation hardware
- Expanding seal
- Smoke-tight expanding seal (for smoke-tight doors)

Accessories:

- OVAL 1701 lock with lower insert label
- Overhead GROOM 200 door closer with guiderail, silver
- Overhead GROOM 200 door closer for double doors, silver

PRICING

Colour group	Price			
	Single door (32 dB)	Smoke-tight single door (32 dB)	Double door (27 dB)	Smoke-tight double door (27 dB)
PVC	£ 1 251,50	£ 1 287,00	£ 2 315,00	£ 2 358,50
CPL	£ 1 186,00	£ 1 221,00	£ 2 227,00	£ 2 266,50
CLPL	£ 1 172,50	£ 1 208,00	£ 2 209,50	£ 2 249,00
FF	£ 1 133,00	£ 1 164,00	£ 2 134,50	£ 2 174,00

OPTIONAL

NON-STANDARD WIDTH	ADDITIONAL COST
100 or 110 wide	50%
≤ 5 mm narrower	£ 57,00
> 5 mm narrower	£ 68,00
wider	£ 68,00
NON-STANDARD HEIGHT	ADDITIONAL COST
Shorter, up to 60 mm	£ 44,00
> 60 mm shorter	£ 48,00
≤ 10 mm taller	£ 52,00
11 mm to 300 mm taller	50%
Extra hinge (required for all door 100 and 110 wide and 110 mm to 300 mm taller)	£ 48,00
Repositioned striker and lock (recommended for non-standard door height)	£ 61,50
OTHER	ADDITIONAL COST
Fire-rated door grille, 300 mm x 150 mm	£ 373,00
Top lock w/cylinder	£ 44,00
200° FOV spyhole	£ 44,00
Door ready for customer-installed lock	£ 79,00
DOOR CLOSERS AND ELECTRIC STRIKES	ADDITIONAL COST
Overhead GROOM 200 door closer with guiderail, silver	no extra fee
Overhead GROOM 200 door closer for double doors, silver	£ 434,00
Mounted ITS96 door closer	£ 351,00
Mounted ITS96 door closer for double doors	£ 1 142,00
PPOZ electric strike	£ 527,00

A door closer must be installed to maintain the regulatory fire rating.

E130 FIRE RATED & SOUNDPROOF

COLOURS:

PVC GROUP



CPL GROUP

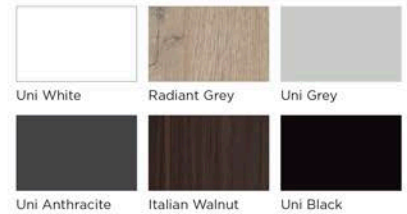

CLPL GROUP



FF GROUP

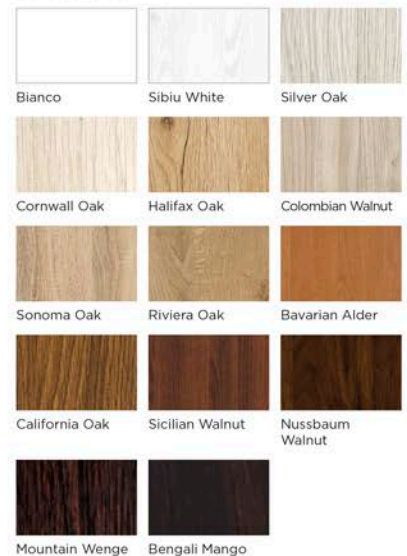

EI60 FIRE RATED & SOUNDPROOF

FRONT INTERNAL SOUND-PROOF DOORS
EI60 FIRE-RATED, CLPL Vintage Oak

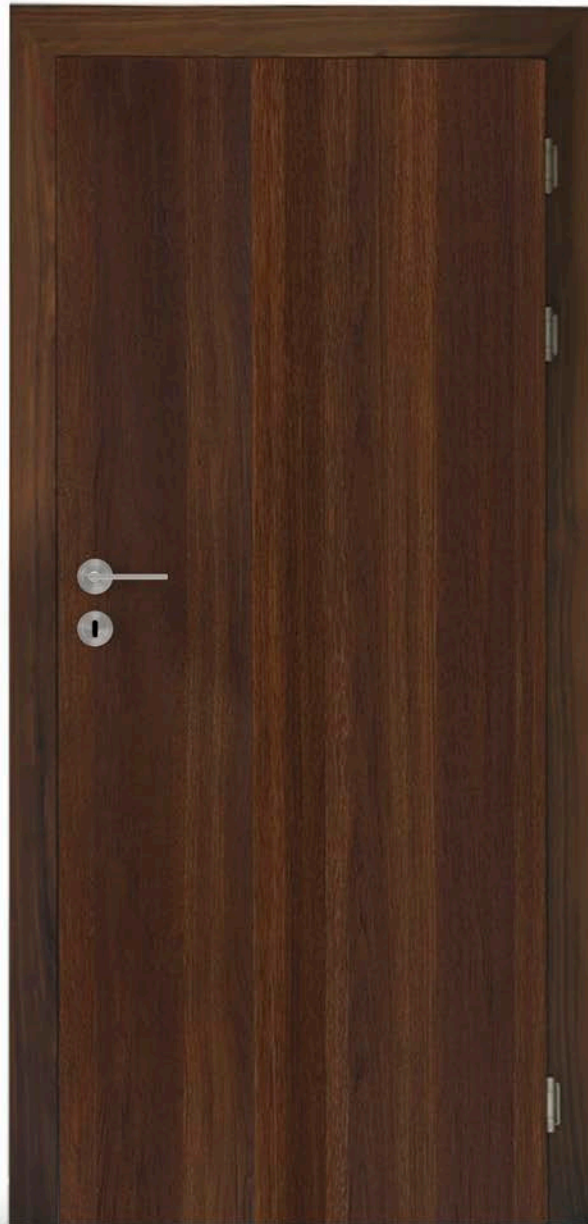

Remember to purchase matching accessories. Explore the front door handle range.

These technical access doors are intended as internal entrance doors. The single-door and double-door versions provide noise insulation of 32 dB and 27 dB, respectively. The door leaf thickness is 60 mm. The technical fire rated access doors can be installed in masonry walls (min. thickness: 115 mm), (reinforced) concrete walls (min. thickness: 100 mm), cellular concrete walls (min. thickness: 175 mm) or EI60 fire rated drywall panel walls (min. thickness: 100 mm).

SIZE TABLE FOR STANDARD DIMENSIONS OF INTERNAL FRONT DOORS

Width		Width in frame clearance, mm	Height in frame clearance, mm	Overall frame width, mm	Overall frame height, mm	Recommended installation opening size, mm (W x H)
Single door	80	801	2017	911	2071	930 x 2081
	90	901	2017	1011	2071	1030 x 2081
	100	1001	2017	1111	2071	1130 x 2081
	110	1101	2017	1211	2071	1230 x 2081

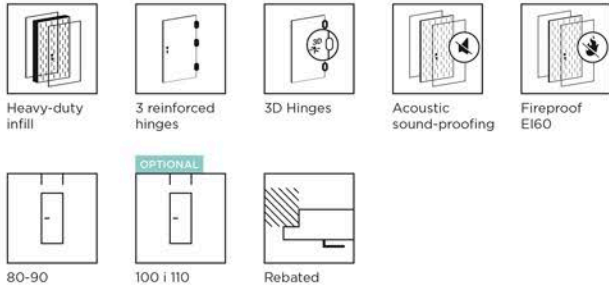

AVAILABLE WIDTH OPTIONS

- 80, 90, other sizes available for an additional charge

STRUCTURE

Door leaf:

- Three-ply chipboard, fire rated, w/o rails, with glued wooden trim around the circumference
- 3 mm HDF lining

Door frame:

- Fixed, timber: 54 mm x 90 mm

FIXTURES

Door leaf:

- Mortice lock with a Euro profile cylinder
- Adjustable pintle hinges, 3 pcs.
- Drop-down seal

Door frame:

- Striker
- Adjustable pintle hinges, 3 pcs.
- Soundproofing gasket
- Installation hardware
- Expanding seal
- Smoke-tight expanding seal (for smoke-tight doors)

Accessories:

- OVAL 1701 lock with lower insert label
- Overhead GROOM 200 door closer with guiderail, silver
- Overhead GROOM 200 door closer for double doors, silver

PRICING

Colour group	Price			
	Single door (32 dB)	Smoke-tight single door (32 dB)	Double door (27 dB)	Smoke-tight double door (27 dB)
PVC	£ 1 317,50	£ 1 353,00	£ 2 429,00	£ 2 473,00
CPL	£ 1 247,50	£ 1 282,50	£ 2 337,00	£ 2 376,50
CLPL	£ 1 230,00	£ 1 265,00	£ 2 315,00	£ 2 354,50
FF	£ 1 186,00	£ 1 216,50	£ 2 244,00	£ 2 284,00

OPTIONAL

NON-STANDARD WIDTH	ADDITIONAL COST
100 or 110 wide	50%
≤ 5 mm narrower	£ 57,00
> 5 mm narrower	£ 68,00
wider	£ 68,00

NON-STANDARD HEIGHT	ADDITIONAL COST
Shorter, up to 60 mm	£ 44,00
> 60 mm shorter	£ 110,00 (135,30)
≤ 10 mm taller	£ 120,00 (147,60)
11 mm to 300 mm taller	50%
Extra hinge (required for all door 100 and 110 wide and 110 mm to 300 mm taller)	£ 110,00 (135,30)
Repositioned striker and lock (recommended for non-standard door height)	£ 140,00 (172,20)

OTHER	ADDITIONAL COST
Fire-rated door grille, 300 mm x 150 mm	£ 850,00 (1045,50)
Top lock w/cylinder	£ 44,00
200° FOV spyhole	£ 44,00
Door ready for customer-installed lock	£ 180,00 (221,40)

DOOR CLOSERS AND ELECTRIC STRIKES	ADDITIONAL COST
Overhead GROOM 200 door closer with guiderail, silver	no extra fee
Overhead GROOM 200 door closer for double doors, silver	£ 990,00 (1217,70)
Mounted ITS96 door closer	£ 800,00 (984,00)
Mounted ITS96 door closer for double doors	£ 2600,00 (3198,00)
PPOZ electric strike	£ 1200,00 (1476,00)

A door closer must be installed to maintain the regulatory fire rating.

E160 FIRE RATED & SOUNDPROOF

COLOURS:

PVC GROUP



CPL GROUP

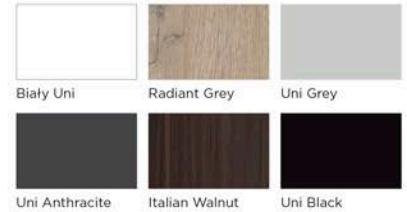

CLPL GROUP



FF GROUP

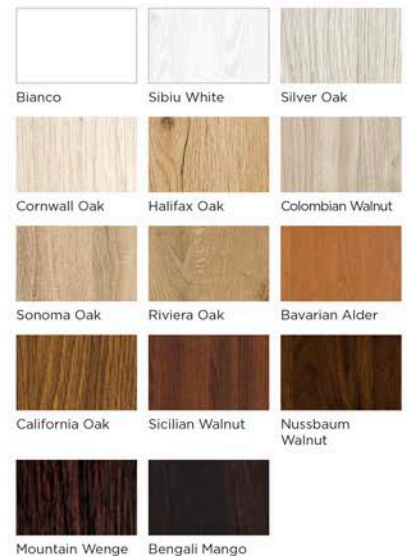

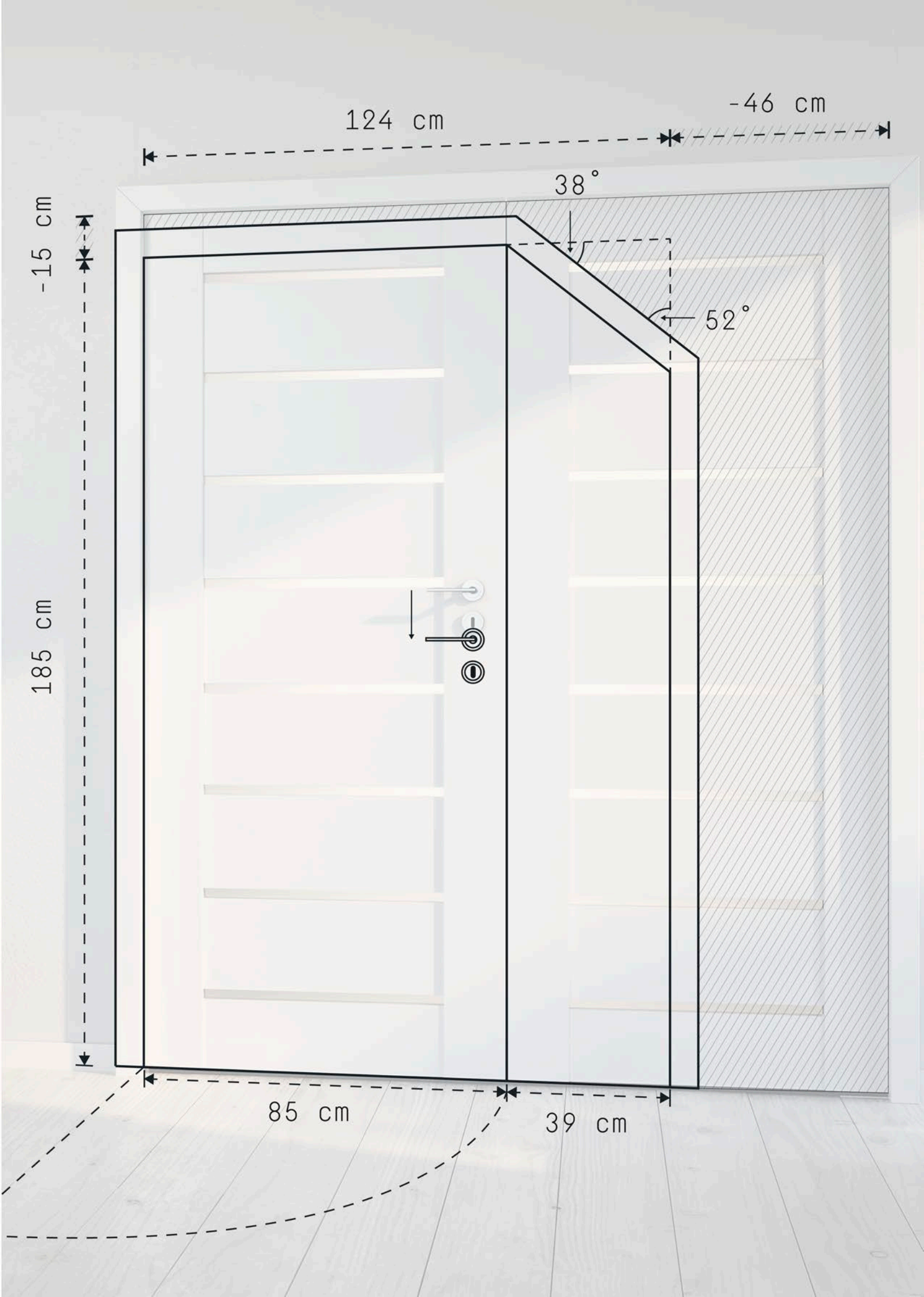

124 cm

-46 cm

-15 cm

185 cm

38°

52°

85 cm

39 cm

SIMPLE NON-REBATED DOOR SYSTEM

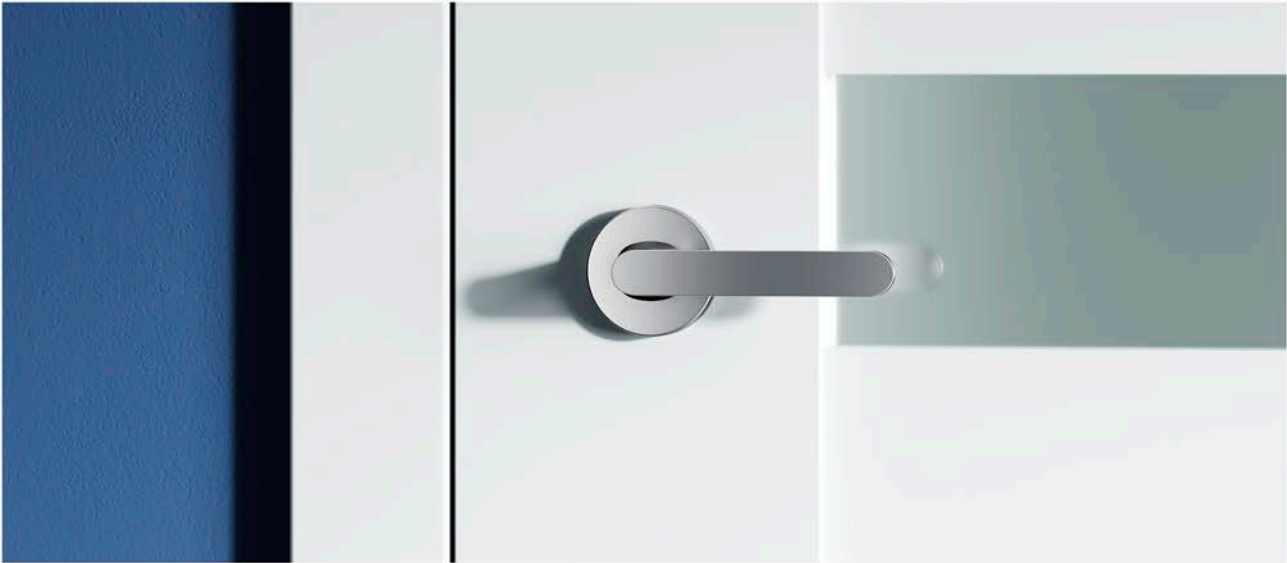

The SIMPLE non-rebated door system is available for all models of BRILLIANT, PRESTIGE and BASIC door. Each door features two flush hinges adjustable in three different directions and a magnetic lock with a key-operated, blocking option or cylinder-equipped - patent or economy (without the lower hole, ensuring a soft closing). Different height of the SIMPLE door contributes to changing the position of hinges and the lock.



3D flush hinges



Magnetic lock in door leaf



Magnetic lock striker in frame



SIMPLE fixed timber frame



SIMPLE fixed MDF frame



SIMPLE adjustable DIN



A USEFUL TIP

For doors with the SIMPLE system, handles are fitted to their own dedicated plate.

AVAILABLE WIDTH OPTIONS

- 60, 70, 80, 90, other sizes available for an additional charge

COLOURS

- Consult the specific door leaf and frame specifications

STRUCTURE

- Consult the specific door leaf and frame specifications

FRAME VERSIONS

- fixed: timber and MDF, size: 44 mm × 100 mm
- adjustable: DIN within regulations min. (100-120)
- and larger

PRICING

Colour group	Price	
	SIMPLE non-rebated door leaf	SIMPLE non-rebated frame
PP		
CPL	Specific model pricing + additional cost of £ 87,50	Specific model pricing + additional cost of £ 87,50
CLPL		
FF		

FIXTURES

Door leaf:

- Magnetic lock, key operated (can be replaced with a lock with blocking option, a Euro profile cylinder lock or without a keyhole)
- standard, key operated lock for double doors with a rebate fitted where doors meet (can be replaced with a Euro profile cylinder lock or without a keyhole)
- 2 flush hinges, 3D adjustable

Door frame:

- 3D flush hinges, 2 pcs.
- Magnetic lock striker
- Weatherstrip
- Installation hardware

OPTIONAL

	ADDITIONAL COST
additional hinge in the door leaf (applies to taller doors)	£ 39,50
additional hinge in the frame (applies to taller frames)	£ 39,50
bolt diameter reducer for WC lock	£ 2,00

Other options available for a additional charge according to the model of door and frame.



See detailed size options and specifications for the SIMPLE non-rebated system

CONTRAST DOOR SYSTEM



BASIC STANDARD 01, CPL Uni White + Uni Black

The CONTRAST system is available for doors in the BASIC Collection series and as HOMEFFE front doors. The system allows for the selection of an edging (a veneer strip over the leading edge of the door) in a colour different from the door leaf surface.

Mix and match the colours of your door leaf and frame.

The system is available for rebated and non-rebated doors.

OPTIONAL

CONTRAST system

Additional cost for CONTRAST with a BASIC door leaf

ADDITIONAL COST

£ 24,00

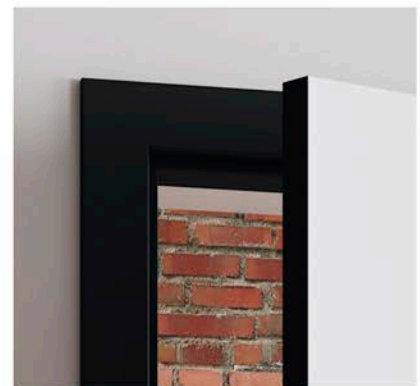

reversible door

standard SIMPLE door

BASIC STANDARD 01, CPL Uni-Grey

REVERSIBLE DOORS

The reversible door system is available in the BASIC Collection complete with adjustable DIN frames. Full specifications (including door leaf colours) can be found in the sections for BASIC models and adjustable DIN frames. Frames for the reversible door system are only available with standard corners with 60mm edging fixed at 45° to walls with a minimum thickness of 100mm.

OPTIONAL

Reversible door system	ADDITIONAL COST
Reversible door leaf	£ 109,50
Reversible adjustable DIN frame	£ 109,00
Bolt width reducer for WC lock	£ 2,00
Additional hinge in the door leaf (applies to taller doors)	£ 43,50
Additional hinge in the frame (applies to taller frames)	£ 43,50



A USEFUL TIP

When ordering a reversible door, don't forget to check the threshold joint, which should line up with the bottom of the door leaf.

REVERSIBLE DOOR WITH DIN FRAME

WIDTH	width in frame clearance W [mm]	width for exterior offrame W2 [mm]	width for frame with edging W3 [mm]	width of entire door leaf S2 [mm]	height in frame clearance H1 [mm]	height of entire door leaf H2 [mm]	height for exterior offrame H3 [mm]	height for frame with edging H4 [mm]
60	628	694	792	644	2006	2006	2039	2088
70	728	794	892	744				
80	828	894	992	844				
90	928	994	1092	944				
100	1028	1094	1192	1044				
110	1128	1194	1292	1144				

1144 Reversible doors are produced shorter as standard. As a result, when mounted next to regular doors, both frames have the same height with edging = 2088 mm. It is possible to order corner wideners +20 mm or create a unit in a non-standard size.

INVISIBLE FLUSH DOORS



BASIC INVISIBLE, PAINT-ME

180° OUTSWINGING DOORS

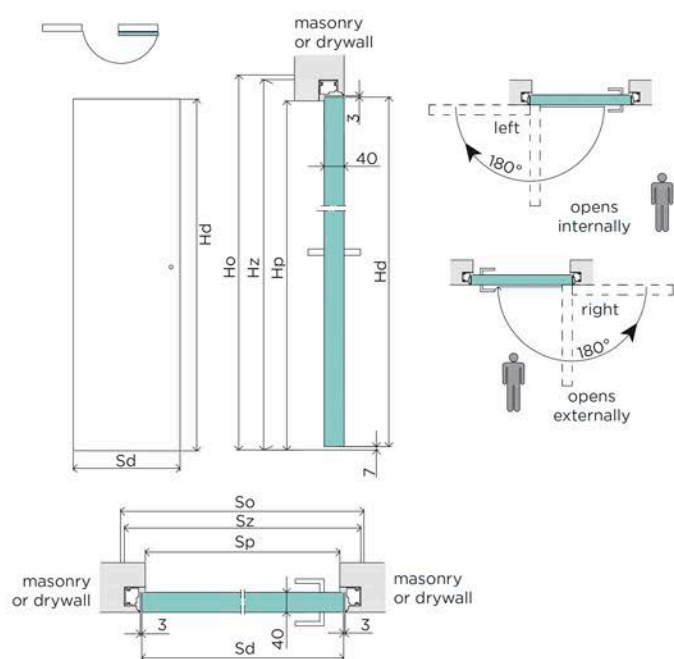

90° INSWINGING DOORS

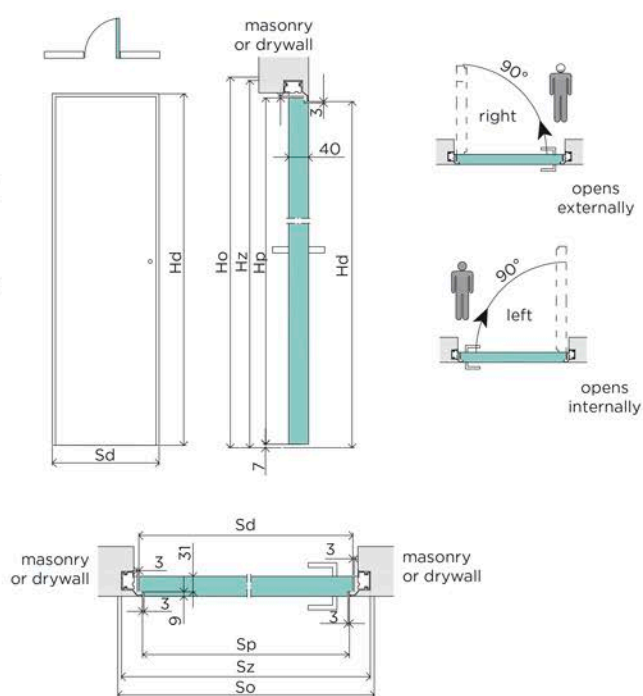

STANDARD SIZES OF INVISIBLE DOORS

Type	Door leaf height Hd, mm	Installation opening height Ho, mm	Overall frame height Hz, mm	Clear height Hp, mm	Clear height Hp, mm
90° inswinging	2030	2080	2072	2030	2
180° outswinging	2020	2070	2062	2020	2

Clear height Hp, mm	Installation opening width So, mm	Installation opening width So, mm	Clear width Sp, mm	
			90° inswing	180° outswing
744	824	814	696	729
844	924	914	796	829
944	1024	1014	896	929

INVISIBLE – WALL-FLUSH DOORS

INVISIBLE doors are available non-rebated and finished with a PAINT-ME lining which can be finished with wall paint or wallpaper to match the wall colour and allow the door to blend in so well that it becomes almost invisible. The doors are also available with PVC, CPL, CLPL or FF colour group lining. A standard INVISIBLE door features 2 flush hinges and a key-operated magnetic lock (which can be replaced with a lock with blocking option, a Euro profile cylinder lock or without a keyhole). The whole frame is made from aluminium sections and designed to let the door close perfectly flush with the wall. There are also frame designs for masonry walls and drywall partitions.

AVAILABLE WIDTH OPTIONS

- 60, 70, 80, 90, other sizes available for an additional cost

STRUCTURE

- MDF stile & rail (timber is optionally available for an extra charge)
- Infill: honeycomb stabilizing core
- 3 mm HDF lining

PRICING

Colour group	Price		
	INVISIBLE door leaf, 180° outswinging (width 60-90)	INVISIBLE door leaf, 90° outswinging (width 60-90)	Aluminium frame for masonry or drywall panel (width. 60-90)
PAINT-ME	£ 158,00	£ 193,00	
PVC	£ 274,50	£ 309,50	
CPL	£ 208,50	£ 243,50	£ 461,00
CLPL	£ 204,00	£ 239,00	
FF	£ 158,00	£ 193,00	

Specify in your order the wall material type (masonry or drywall panel) for frame installation.

OPTIONAL ACCESSORIES – DOOR LEAF

NON-STANDARD WIDTH	ADDITIONAL COST
100 or 110 wide	£ 30,50
≤ 5 mm narrower	£ 30,50
> 5 mm narrower	£ 41,50
Wider	£ 41,50
NON-STANDARD HEIGHT	ADDITIONAL COST
Shorter, up to 60 mm	£ 21,50
> 60 mm shorter	£ 26,50
≤ 10 mm taller	£ 26,50
11 mm to 450 mm taller	£ 61,50
Extra hinge (required for all door leaves 110 wide and 110 mm to 450 mm taller)	£ 39,50
Repositioned lock (recommended for non-standard door height)	£ 30,50
VENTILATION	ADDITIONAL COST
Ventilation cut	£ 13,00
Plastic vent sleeves (set of)	£ 9,00
Ventilation sleeves with nickel or bronze covers (piece)	£ 13,00
Plastic door grille	£ 17,50
Plastic door grille, flat silver	£ 26,50
Stainless steel door grille	£ 105,00
OTHER	ADDITIONAL COST
Solid panel infill (add an extra hinge charge for door width sizes 60, 70 and 80)	£ 52,50
Timber stile & rail	£ 21,50
Bolt diameter reducer for WC lock	£ 2,00
Drop-down seal (for 180° outswinging doors)	£ 43,50

OPTIONAL ACCESSORIES – DOOR FRAME

NON-STANDARD WIDTH	ADDITIONAL COST
100 or 110 wide	£ 87,50
Non-standard width	30%
NON-STANDARD HEIGHT	ADDITIONAL COST
Non-standard height	30%
Repositioned striker (recommended for non-standard door height)	£ 30,50
Extra hinge (required for all door frames 110 wide and 110 mm to 450 mm taller)	£ 39,50

FIXTURES

Door leaf:

- Concealed hinges, 2 pcs.
- Magnetic lock
(can be replaced with lock a lock with blocking option and bolt width reducer, a Euro profile cylinder lock or without a keyhole)

Aluminium frame:

- Concealed hinges, 2 pcs.
- Striker
- Weatherstrip
- Installation hardware

COLOURS:

DIY PAINT OR WALLPAPER FINISHED FILM



PAINT-ME

PVC GROUP



Textured White



Super-flat Grey



Natural Grandson Oak

CPL GROUP



Uni White



Radiant Grey



Uni Grey



Uni Anthracite



Italian Walnut



Uni Black

CLPL GROUP



Whitewash Larch



Honey Oak



Grey Larch



Spanish Oak



Vintage Oak



Black Larch

FF GROUP



Bianco



Sibiu White



Silver Oak



Cornwall Oak



Halifax Oak



Colombian Walnut



Sonoma Oak



Riviera Oak



Bavarian Alder



California Oak



Sicilian Walnut

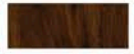

Nussbaum Walnut

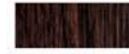

Mountain Wenge



Bengali Mango

DOORS WITH SLANTED CORNERS

PRESTIGE PL-01 Slanted, FF Halifax Oak



Doors with slanted corners are available in a limited selection of colours and models, depending on the door opening. Custom glazing options are available for non-standard sizes of slant-corner doors. Given the product design and manufacturing complexity, each purchase order requires a manufacturability assessment. Ask for a quote referencing the required dimensions.

COLOURS

- Consult the specific door leaf and frame specifications

AVAILABLE WIDTH OPTIONS

- 60, 70, 80, 90, other sizes available for an additional charge

DESIGN AND FIXTURES

- Consult the specific door leaf and frame specifications

FRAME VERSIONS

- Fixed: timber & MDF

SLANTED-CORNER EXTRA PRICES

Product type	Price	
	Door leaf	Fixed timber or MDF frame
PRESTIGE	Selected model pricing + £ 417,00	Selected model pricing + £ 219,50
BASIC	Selected model pricing + £ 175,50	Selected model pricing + £ 175,50



INSET DOORS WITH HATCHES



INSET is a collection of rebated doors with hatches. The door features a solid panel infill with an opening hatch, a ledge available in any size and is closed by a roller shutter locked with latch bolts. The maximum hatch width is the overall door width minus 360 mm.

STRUCTURE

- MDF stile & rail (timber is optionally available for an additional charge)
- Solid panel infill
- 3 mm HDF lining

FRAME VERSIONS

- Fixed: timber & MDF
- Adjustable: DIN, DUALE,

FIXTURES

- Mortice lock with a Euro profile cylinder
- 3D pivot hinges, 3 pcs.
- PVC roller shutter with latch bolts
- Ledge

PRICING

Colour group	Price	
	INSET door leaf Single door, 60-90	Door frame
PVC	£ 812,50	Selected model pricing w/o extra charge
CPL	£ 751,00	
CLPL	£ 742,00	
FF	£ 698,00	
LAK	£ 685,00	

AVAILABLE WIDTH OPTIONS

- 60, 70, 80, 90, other sizes available for an additional charge

COLOURS:

- Ref. the STANDARD 01 range

ROLLER SHUTTER COLOURS

- White, Beige, Silver, Graphite, Golden Oak, Walnut, Black

SHAFT BOX, GUIDE RAILS AND COLOURS

- White, Brown

OPTIONAL

TIMBER STILE & RAIL	ADDITIONAL COST
Timber stile & rail	£ 17,50

BASIC SWING FF Silver Oak, Porthole, stainless steel plated
horizontal retro cement panels, 2 set

SWING SWINGING DOORS

SWING doors are non-rebated, either solid or with porthole windows, and available in any size from 60 to 200 in width as single or double doors.



SWING - SWINGING DOORS

AVAILABLE WIDTH OPTIONS

- 60-200, other sizes available for an additional charge

STRUCTURE

- Timber stile & rail
- Solid panel infill
- 3 mm HDF lining

FIXTURES

- 3 double-action spring hinges in single doors
- 4 double-action spring hinges in 60-90 double doors
- 6 double-action spring hinges in 100-200 double doors

OPTIONAL ACCESSORIES

- Porthole window, glazed with clear or Lacomat glass; other glazing options include clear safety glass, Lacomat, or a one-way mirror (ask for a quote)
- Double-sided bolsterring with a horizontal stainless steel sheet panel up to 170 mm from the base of the door, other sheet panel sizes available, also in horizontal or vertical versions (ask for a quote)

FRAME VERSIONS

- Fixed: timber, MDF

PRICING

Colour group	Price			Door frame
	Single door 60-90	Double door 60-90	Double door, 100-200	
PVC	£ 549,00	£ 773,00	£ 1 098,00	Specific frame pricing + additional cost of £ 57,00
CPL	£ 487,50	£ 716,00	£ 975,00	
CLPL	£ 478,50	£ 707,00	£ 957,50	
FF	£ 430,50	£ 658,50	£ 861,00	
LAK	£ 417,00	£ 645,50	£ 834,50	

OPTIONAL

	ADDITIONAL COST
additional hinge	£ 516,50
nickel coloured hinge - fitted as standard	no charge
black or gold coloured hinges	£ 131,50
PORTHOLE WITH LACOMAT* GLASS OR TRANSPARENT	ADDITIONAL COST
Ø ext. 240 mm, Ø int. 135 mm (minimum door width 340 mm)	£ 131,50
Ø ext. 320 mm, Ø int. 215 mm (minimum door width 420 mm)	£ 224,00
Ø ext. 400 mm, Ø int. 280 mm (minimum door width 500 mm)	£ 307,50
safety or venetian mirror glazing	priced individually
2-SIDED HORIZONTAL REINFORCEMENT PANELS, STAINLESS STEEL PLATED (SET)	ADDITIONAL COST
horizontal reinforcement up to 170 mm	£ 197,50
horizontal reinforcement over 170 mm	priced individually
vertical reinforcement	priced individually

Handles	ADDITIONAL COST
U01OK round	£ 17,50
U03KW square	£ 17,50
U02OW oval	£ 35,00
U04PR rectangular	£ 35,00

HANDLES



U01OK round



U03KW square



U02OW oval

U04PR rectangular

Flush pull	ADDITIONAL COST
P05OK round	£ 39,50
P06KW square	£ 39,50

FLUSH PULL



P05OK round



P06KW square

Colours (from left to right):

- matt chrome
- polished chrome
- black
- patina
- polished gold
- matt gold

COLOURS:

PVC GROUP



CPL GROUP

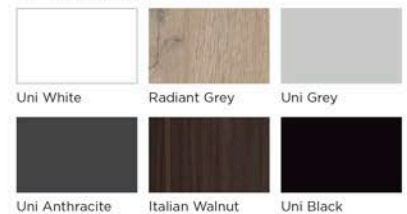

CLPL GROUP



FF GROUP

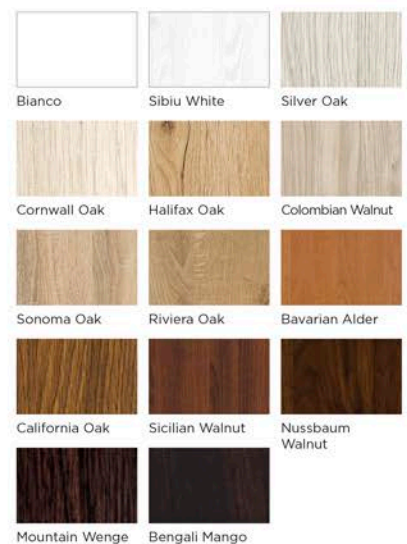

LAK GROUP

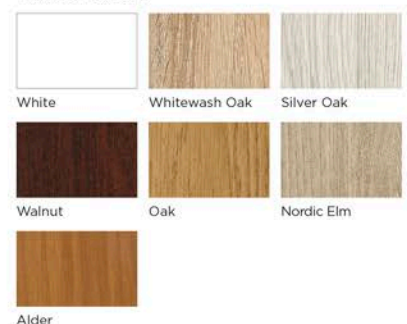

PRESTIGE PL-02, CPL Uni White

DOUBLE DOORS



LEFT HAND DOUBLE DOORS

Double door active leaf

Double door inactive leaf

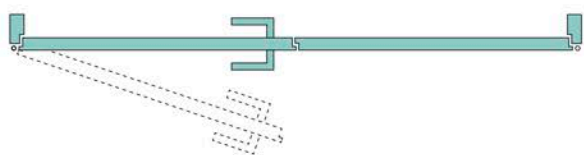

LEFT HAND DOUBLE DOORS

Double door inactive

Double door active leaf

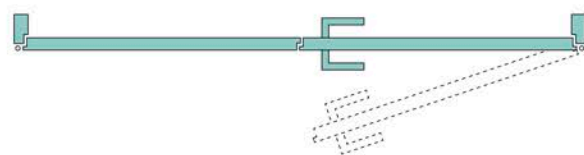

DOUBLE DOORS

Double doors are rebated and available in all VIVENTO colours and models, width combinations (including asymmetric leaves) and in any size. See the selected door model specifications. Double doors are also available in the SIMPLE Collection as well, with the active and inactive door leaves closing together at a rebate.

AVAILABLE WIDTH OPTIONS

- 100, 110, 120, 130, 140, 150, 160, 170, 180, 190, 200, other sizes available for an additional charge

COLOURS

- Consult the specific door leaf and frame specifications

FIXTURES

Double door active leaf:

- Mortice lock, key operated (can be replaced with a lock with blocking option, a Euro profile cylinder lock or without a keyhole)
- Mortice-style pintle hinges, 2 pcs. (3 pcs. for BRILLIANT and PRESTIGE door leaf width 90)

Double door inactive leaf:

- Striker
- Counter-facing bolts
- Mortice-style pivot hinges, 2 pcs. (3 pcs. for BRILLIANT and PRESTIGE door leaf width 90)
- Caution: for unsymmetrical double doors, ensure a matching number of hinges on each door leaf. Allow for additional hinge charges as per current listed price.

Door frame:

- Mortice-style pivot hinges, 4 pcs. (6 pcs. in the frame of 90, BRILLIANT and PRESTIGE doors)
- Weatherstrip
- Installation hardware

STRUCTURE

- Frame of timber, stile & rail door leaves
- Infill and facing: see the specific door model specifications

FRAME VERSIONS

- Fixed: timber & MDF
- Adjustable: DIN, DUALE, ZOS (not available with the BRILLIANT Collection)



Counter-



Striker on the inactive leaf

PRICING

Colour group	Price			
	Double door active leaf	Double door inactive leaf		Timber stile & rail (available for active door leaves which are with MDF stiles and rails in standard versions; not available in BRILLIANT and PRESTIGE doors)
		BRILLIANT and PRESTIGE	BASIC	
PP				
CPL	Selected model pricing, w/o extra charge	Selected model pricing + additional charge per door leaf width, see the table below	Specific model pricing + additional charge of £ 39,50	£ 21,50 for the active door leaf £ 21,50 for the passive door leaf
CLPL				
FF				
LAK				

OPTIONAL

BRILLIANT AND PRESTIGE	ADDITIONAL COST
Double door inactive leaf, width S2: 420-609 mm	£ 188,50
Double door inactive leaf, width S2: 610, 710, 810, 910 mm	£ 39,50
Double door inactive leaf, width S2: 1010 mm	£ 70,00
BASIC STANDARD 01	ADDITIONAL COST
Double door inactive leaf, width S2 less than 610 mm (only Standard 01; requires additional cost for timber frame)	£ 81,00

WALL-MOUNTED SLIDING DOORS

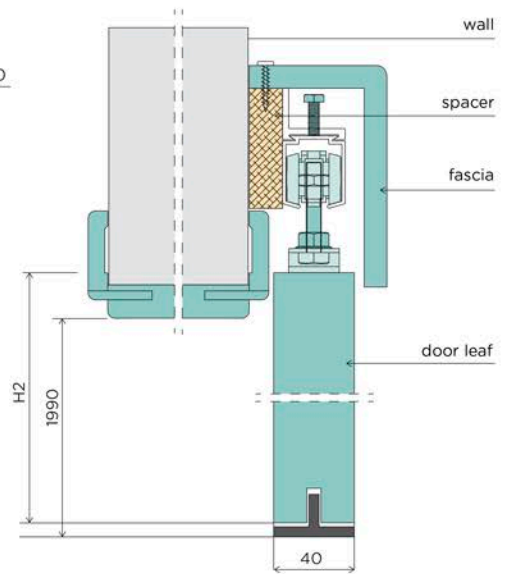
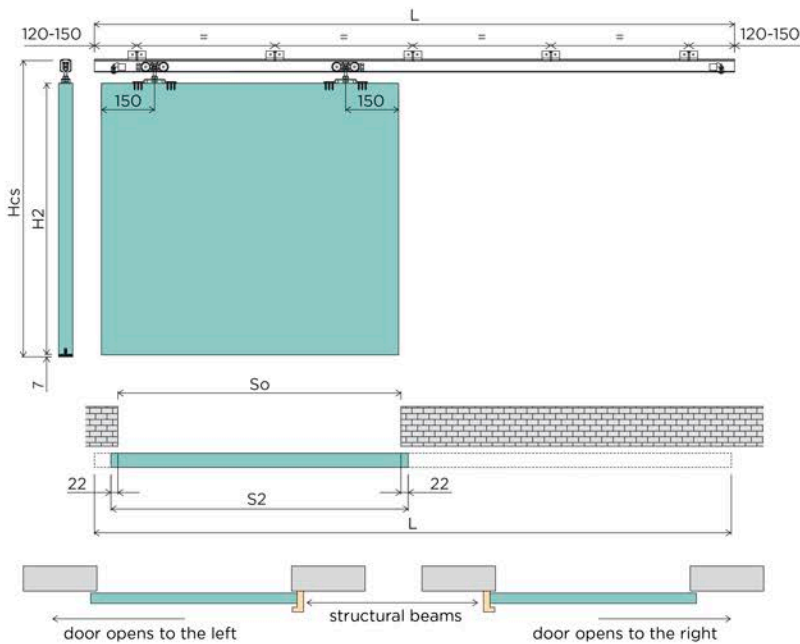

When installing the sliding door with a „tunnel“ frame (the figure shows a DIN TUNEL frame), the frame height needs to be trimmed from the bottom.

DIMENSIONS TABLE

Size	S2 [mm]	So [mm]	H2 [mm]	Hcs [mm]	L [mm]
60	644	600	2030	2098-2103	1300
70	744	700			1500
80	844	800			1800
90	944	900			2000

- S2** maximum overall door leaf width
- So** installation opening width
- H2** maximum overall door leaf height
- Hcs** overall system size without pulls (adjusted on running trucks)
- L** sliding mechanism length

WALL-MOUNTED SLIDING DOORS

The sliding doors are non-rebated and available in all VIVENTO colours and models and in any size. Refer to the selected door leaf model specifications. A standard sliding door leaf features a Type O6 pull (which can be replaced with a Type O7 pull, free of charge) and a milled slot at the bottom to accommodate a stop for vertical door leaf stability.

EACH WALL-MOUNTED SINGLE SLIDING DOOR SET INCLUDES:

- sliding non-rebated door leaf with round matt chrome U01OK handle
- The sliding system components set includes:
 - sliding mechanism with stabiliser
 - spacer
 - fascia (to conceal the mechanism)
- OPTIONAL: structural beam
- OPTIONAL: hook bolt lock
- OPTIONAL: tunnel frame

SINGLE DOOR SYSTEM PRICING

Colour group	width: 60, 70, 80, 90		width: 100 i 110	
	Door leaf	Sliding system components set (sliding mechanism with a stabiliser section + fender beam + fascia)	Door leaf	Sliding system components set (sliding mechanism with a stabiliser section + fender beam + fascia)
CPL		£ 237,00 £ 131,00 £ +35,50 £ +70,00		£ 325,00 £ 184,50 £ +43,50 £ +96,50
CLPL	door leaf price + additional cost £ 21,50	£ 228,00 £ 131,00 £ +30,50 £ +65,50	door leaf price + additional cost £ 52,50	£ 316,00 £ 184,50 £ +39,50 £ +92,00
FF i LAK		£ 206,00 £ 131,50 £ +21,50 £ +52,50		£ 294,00 £ 184,50 £ +30,50 £ +79,00

The wall-mounted sliding door system in the double door version consists of double the amount of elements as the single door version. In addition, we recommend fitting an interlock mechanism for £ 9,00. The double door system doesn't include a fender beam or hook lock.

OPTIONAL

FENDER BEAM	CPL		CLPL	FF i LAK	ADDITIONAL COST
fender beam	£ 70,00		£ 61,50		£ 52,50
OTHER				ADDITIONAL COST	
Structural beam taller than standard					£ 52,50
non-standard size set of components for a sliding door system					50%
hook lock with a key or Euro cylinder insert, with round or square handle					£ 65,50
hook lock with blocking option, with round or square handle					£ 74,50

When choosing a hook lock, we recommend choosing a similar shaped handle: round or square. We fit the matt chrome U01OK round handle as standard. It is possible to replace the U01OK round handle with the matt chrome U03KW square handle without additional charge. All other handles incur an additional charge, according to the chosen door model.

HANDLES



U01OK round



U03KW square



U02OW oval

U04PR rectangular

FLUSH



P05OK round



P06KW square

Colours (from left to right):

- matt chrome
- polished chrome
- black
- patina
- polished gold
- matt gold

AVAILABLE WIDTH OPTIONS

- 60, 70, 80, 90, other sizes available for an additional charge

COLOURS

- according to available options for the chosen door model, not applicable for colours from the PVC or PP groups

STRUCTURE

- Refer to the door specifications

FRAME VERSIONS

- Fixed: timber & MDF in the tunnel version
- Adjustable: DIN, DUALE, ZOS, timber, and exclusive in the tunnel version

FIXTURES

- Refer to the door specifications

SLIDING DOOR SYSTEM COMPONENTS



Stabilizer section



Fascia



Steel fixture



Shimming flat bar



Hook lock, with round or square handle



Fender beam

It is possible to order a hook lock in the required handle colour for an 30% additional charge to the standard matt chrome lock cost.

UCHWYTY	DOPLATA
U01OK round	£ 17,50
U03KW square	£ 17,50
U02OW oval	£ 35,00
U04PR rectangular	£ 35,00

Pochwyty	DOPLATA
P05OK round	£ 90,00 (110,70)
P06KW square	£ 90,00 (110,70)

BASIC STANDARD 01 MAGIC, PVC Natural Grandson Oak

WALL-MOUNTED SLIDING DOORS MAGIC

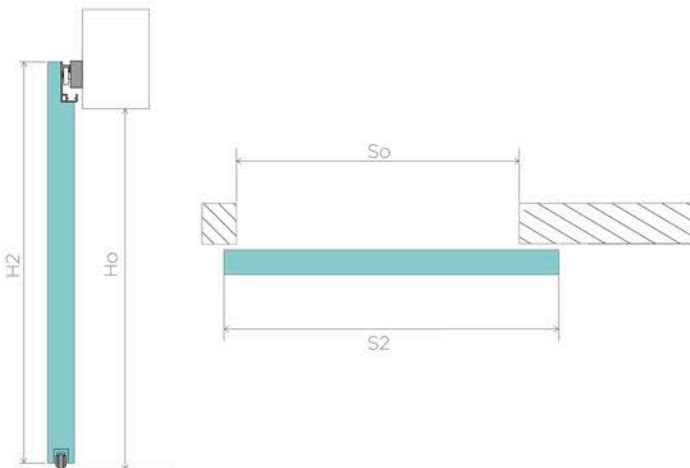

DIMENSIONS TABLE

Size	S2 [mm]	S _o [mm]	H2 [mm]	H _o [mm]
80	844	626	2030	1970
90	944	726		
100	1044	826		
110	1144	926		

S2 maximum overall door leaf width
S_o installation opening width
H2 maximum overall door leaf height
H_o installation opening height

MAGIC WALL-MOUNTED SLIDING DOORS

Sliding doors, reinvented in a minimalist and progressive style. The sliding door are non-rebated and available in all colours and models of the BASIC Collection, in any size, according to the door model options. Refer to the selected door model specifications. A standard sliding door features a matt chrome U010K round handle pull as well as a milled slot at the bottom to accommodate a stop for vertical door stability.

The unique nature of this product lies with its completely hidden mechanism. This solution requires a significantly wider door leaf than the opening in the wall, therefore the minimum MAGIC door width is „80“.

EACH MAGIC WALL-MOUNTED SINGLE SLIDING DOOR SET INCLUDES:

- Any door leaf with a pull
- Sliding mechanism

AVAILABLE WIDTH OPTIONS

- 80, 90, other sizes available for an additional charge
- minimum door leaf width: 844 mm
- maximum door leaf width: 1144 mm

COLOURS, STRUCTURE AND FIXTURES

- Refer to the door specifications

PRICING

Colour group	width: 80, 90		width: 100 i 110	
	Door leaf	MAGIC sliding mechanism	Door leaf	MAGIC sliding mechanism
PP i PVC				
CPL	door leaf cost	£ 746,50	door leaf cost	£ 790,50
CLPL	+ additional £ 43,50		+ additional £ 74,50	
FF i LAK				

When choosing a hook lock, we recommend choosing a similar shaped handle: round or square. We fit the matt chrome U010K round handle as standard. It is possible to replace the U010K round handle with the matt chrome U03KW square handle without additional charge.

HANDLES	ADDITIONAL COST
U010K round	£ 17,50
U03KW square	£ 17,50
U020W oval	£ 35,00
U04PR rectangular	£ 35,00

FLUSH PULL	ADDITIONAL COST
P050K round	£ 39,50
P06KW square	£ 39,50

HANDLES



U010K round

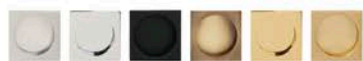

U03KW square



U020W oval

U04PR rectangular

FLUSH



P050K round



P06KW square

Colours (from left to right):

- matt chrome
- polished chrome
- black
- patina
- polished gold
- matt gold

NEW ARRIVAL

BASIC STANDARD 01 LOFT, FF Riviera Oak

WALL-MOUNTED SLIDING DOORS LOFT

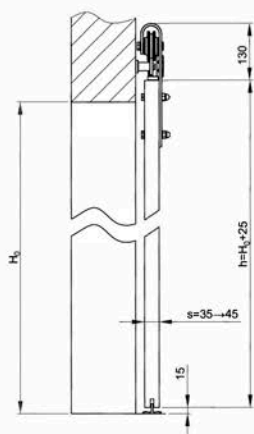

DIMENSIONS TABLE

Door	S2 [mm]	So [mm]	H2 [mm]	Ho [mm]
80	844	626	2030	1970
90	944	726		
100	1044	826		
110	1144	926		

S2 maximum overall door leaf width
So installation opening width
H2 maximum overall door leaf height
Ho installation opening height

IN-WALL SLIDING DOORS

The latest edition of the LOFT sliding door system, with exposed mechanical elements to give your interior a unique industrial character.

FEATURES:

- roller bearings ensure a quiet and smooth operation
- easy installation as well as option to leave the door in an open position
- painted guide rail mechanism and all system parts are hard-wearing and designed to prevent dust build up.

EACH COMPLETE LOFT IN-WALL SLIDING DOOR SYSTEM INCLUDES:

- selected door leaf with matt chrome U010K round handle
- sliding mechanism

AVAILABLE WIDTHS

- 80, 90, other sizes available for an additional charge according to chosen BASIC door leaf
- minimum door width: 844 mm
- maximum door width: BASIC 1144 mm, BRILLIANT i PRESTIGE 1044 mm.

AVAILABLE COLOURS, STRUCTURE AND ACCESSORIES

- according to chosen door leaf available options
- BASIC doors used in the LOFT system must be constructed with solid panels, as per price guide

PRICING

Colour group	Width 80, 90	
	Door leaf	LOFT sliding mechanism
PP i PVC		
CPL	door leaf cost	£ 219,50
CLPL	+ additional £21,50	
FF i LAK		

When choosing a hook lock, we recommend choosing a similar shaped handle: round or square. We fit the matt chrome U010K round handle as standard. It is possible to replace the U010K round handle with the matt chrome U03KW square handle without additional charge.

OPTIONAL

OTHER	ADDITIONAL COST
door closer	£ 74,50
interlock mechanism for double doors	£ 6,50

HANDLES	ADDITIONAL COST	FLUSH PULL	ADDITIONAL COST
U010K round	£ 17,50	P050K round	£ 39,50
U03KW square	£ 17,50	P06KW square	£ 39,50
U020W oval	£ 35,00		
U04PR rectangular	£ 35,00		
Black topcoat (1 piece)	£ 17,50		

HANDLES



U010K round

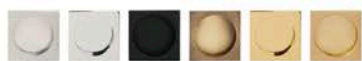

U03KW square



U020W oval

U04PR rectangular

FLUSH



P050K round



P06KW square

LOFT SLIDING DOOR SYSTEM PARTS



mounted guide



door closer



interlock



Handle with black topcoat
32x228 (piece)

Colours (from left to right):

- matt chrome
- polished chrome
- black
- patina
- polished gold
- matt gold



IN-WALL SLIDING DOORS

SINGLE DOOR UNIT

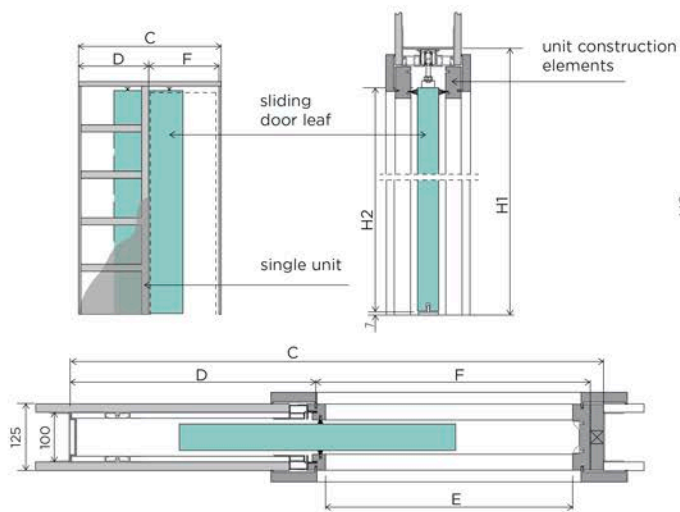

DOUBLE DOOR UNIT

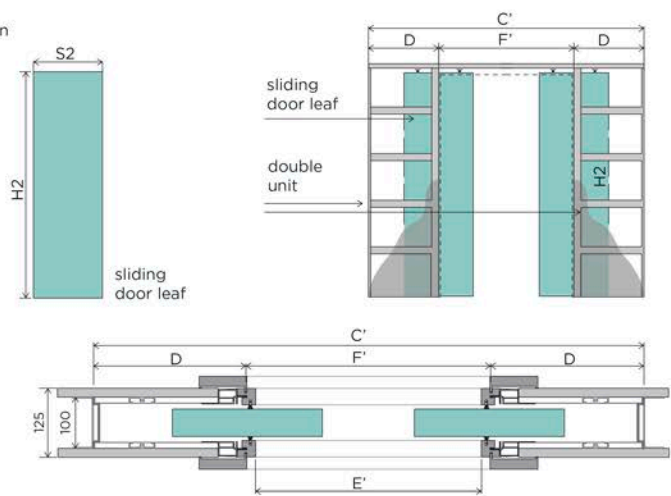

DIMENSIONS TABLE

Door	S2 [mm]	H2 [mm]	C [mm]	C' [mm]	D [mm]	E [mm]	E' [mm]	F [mm]	F' [mm]	H1 [mm]
60	644	2030	1308	2516	653	599	1172	635	1210	2115
70	744		1508	2916	753	699	1372	735	1410	
80	844		1708	3316	853	799	1572	835	1610	
90	944		1908	3716	953	899	1772	935	1810	

- S2** door leaf width
- H2** door leaf height
- C, C'** overall cassette width
- D** unit recess width
- E, E'** passage clear width within the frame
- F, F'** passage clear width outside of the frame
- H1** overall unit height

IN-WALL SLIDING DOORS

These sliding doors are non-rebated and in all VIVENTO colours and models and in any size. Consult the selected door model specifications. A standard sliding door leaf features a Type 06 pull (which can be replaced with a Type 07 pull free of charge) and a bottom milled slot to accommodate a stop for vertical door leaf stability. The in-wall sliding door system can be fitted in walls 125 mm thick.

EACH STANDARD SINGLE DOOR SET INCLUDES:

- Selected sliding non-rebated door leaf with round matt chrome U010K handle
- The sliding system components set includes:
 - cassette with stabiliser
 - brush seals, grey, 3 pcs.
 - cassette installation

SINGLE DOOR SYSTEM PRICING

Colour group	Width: 60, 70, 80, 90		Width: 100 i 110	
	Door leaf	A set of sliding system components (a unit with a stabiliser section + 3 brushes + unit installation trim)	Door leaf	A set of sliding system components (a unit with a stabiliser section + 3 brushes + unit installation trim)
CPL		£ 707,00 £ 483,00 £ +48,50 £ +175,50		£ 786,00 £ 527,00 £ +48,50 £ +210,50
CLPL	door leaf price + additional cost £ 21,50	£ 702,50 £ 483,00 £ +48,50 £ +171,00	door leaf price + additional cost £ 43,50	£ 781,50 £ 527,00 £ +48,50 £ +206,00
FF i LAK		£ 685,00 £ 483,00 £ +48,50 £ +153,50		£ 764,00 £ 527,00 £ +48,50 £ +188,50

When choosing a hook lock, we recommend choosing a similar shaped handle: round or square. We fit the matt chrome U010K round handle as standard. It is possible to replace the U010K round handle with the matt chrome U03KW square handle without additional charge.

The in-wall sliding door system in the double door version consists of double the amount of elements as the single door version. The double door system doesn't include a hook lock.

OPTIONAL

OTHER	ADDITIONAL COST
Set of sliding system components made for non-standard dimension	50%
hook lock with a key or Euro cylinder insert, with round or square handle	£ 65,50
hook lock with blocking option, with round or square handle	£ 74,50

When choosing a hook lock, we recommend choosing a similar shaped handle: round or square. We fit the matt chrome U010K round handle as standard. It is possible to replace the U010K round handle with the matt chrome U03KW square handle without additional charge. All other handles incur an additional charge, according to the chosen door model.

HANDLES



U010K round

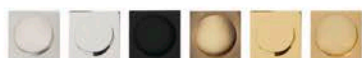

U03KW square



U02OW oval

U04PR rectangular

FLUSH



P05OK round

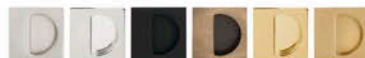

P06KW square

Colours (from left to right):

- matt chrome
- polished chrome
- black
- patina
- polished gold
- matt gold

AVAILABLE WIDTH OPTIONS

- 60, 70, 80, 90, other sizes available for an additional charge

COLOURS

- according to available options for the chosen door model, not applicable for colours from the PVC or PP groups

STRUCTURE

- Refer to the door specifications

FRAME VERSIONS

- Fixed: cassette installation trim
- Adjustable: adjustable cassette installation trim (ask for unit a quote detailing the wall thickness in which the unit will be fitted)

FIXTURES

- Refer to the door specifications

SLIDING DOOR SYSTEM COMPONENTS



Cassette installation trim part



Brush seals



Stabilizer section



Hook lock, with round or square handle

HANDLES	ADDITIONAL COST
U010K round	£ 17,50
U03KW square	£ 17,50
U02OW oval	£ 35,00
U04PR rectangular	£ 35,00

FLUSH PULL	ADDITIONAL COST
P05OK round	£ 39,50
P06KW square	£ 39,50

It is possible to order a hook lock in the required handle colour for an 30% additional charge to the standard matt chrome lock cost.

BASIC FOLD, CLPL Honey Oak

FOLDING DOORS FOLD

The FOLD folding doors are non-rebated and available with solid single leaves (60 to 90 in width) or double solid leaves (100 to 200 in width). Both folding halves of the door are joined with 3 hinges. The door is attached to a floor-mounted stabilizer track. The folding mechanism is installed in the top of the timber frame. This system is recommended for anywhere where there isn't enough room for standard swing or sliding doors.

The maximum single system load capacity is 2 x 25 kg.

Gaps between the floor and lower edge of the door as well as between the top edge of the door and frame are 15 mm.

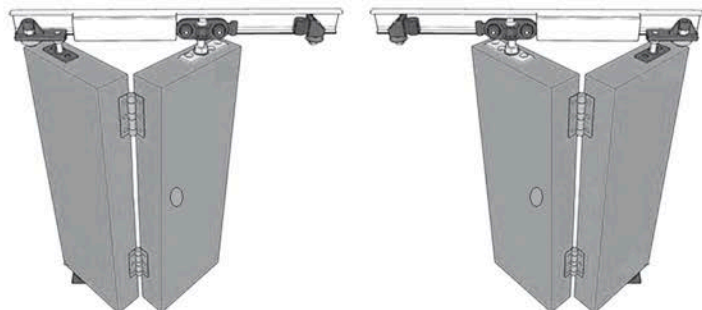

FOLD left
folding doors

FOLD right
folding doors

FOLD - FOLDING DOORS

EACH FOLD FOLDING DOOR SET INCLUDES:

- 2 solid door leaves
- 2 flush hinges
- Folding mechanism
- Timber frame

AVAILABLE WIDTH OPTIONS

- 60-200, other sizes available for an additional charge

STRUCTURE

- MDF stile & rail (timber option available for an additional charge)
- Infill: honeycomb stabilizing core
- 3 mm HDF lining

FRAME VERSIONS

- Fixed: timber

PRICING

Colour group	Price					
	Single door, width 60-90			Double door, width 100-200		
	FOLD door leaf	Fixed timber frame	Folding doors mechanism	FOLD door leaf	Fixed timber frame	Folding door mechanism
CPL	£ 294,00	£ 195,00		£ 588,50	£ 244,00	
CLPL	£ 285,50	£ 191,00	£ 170,00 (209,10)	£ 571,00	£ 238,50	£ 149,00
FF	£ 241,50	£ 180,00		£ 483,00	£ 225,00	
LAK	£ 228,00	£ 180,00		£ 456,50	£ 225,00	

OPTIONAL

PULLS	ADDITIONAL COST
P05OK round	£ 39,50
P06KW square	£ 39,50

FLUSH



P05OK round



P06KW square

Colours (from left to right):

- matt chrome
- polished chrome
- black
- patina
- polished gold
- matt gold

HINGES

HINGES	ADDITIONAL CHARGE
flush hinges in satin nickel colour	no charge, fitted as standard
flush hinges in black or gold	£ 21,50



Flush hinge

A USEFUL TIP

FOLD door sets come with timber frames. A set can be produced up to a maximum height of H3=2074 mm.



COLOURS:

CPL GROUP



Uni White

Radiant Grey

Uni Grey

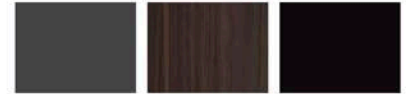

Uni Anthracite

Italian Walnut

Uni Black

CLPL GROUP



Whitewash Larch

Honey Oak

Grey Larch

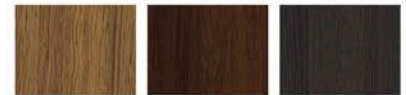

Spanish Oak

Vintage Oak

Black Larch

FF GROUP



Bianco

Sibiu White

Silver Oak



Cornwall Oak

Halifax Oak

Colombian Walnut



Sonoma Oak

Riviera Oak

Bavarian Alder

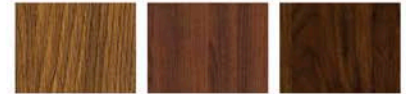

California Oak

Sicilian Walnut

Nussbaum Walnut

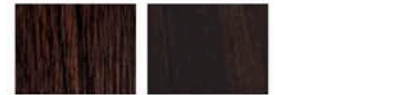

Mountain Wenge

Bengali Mango

LAK GROUP



White

Whitewash Oak

Silver Oak



Walnut

Oak

Nordic Elm



Alder

Adjustable DIN frame, DIN PLUS RETRO edging, CLPL Uni White



FIXED FRAME TIMBER



Fixed timber „tunnel” frame

DETAILS

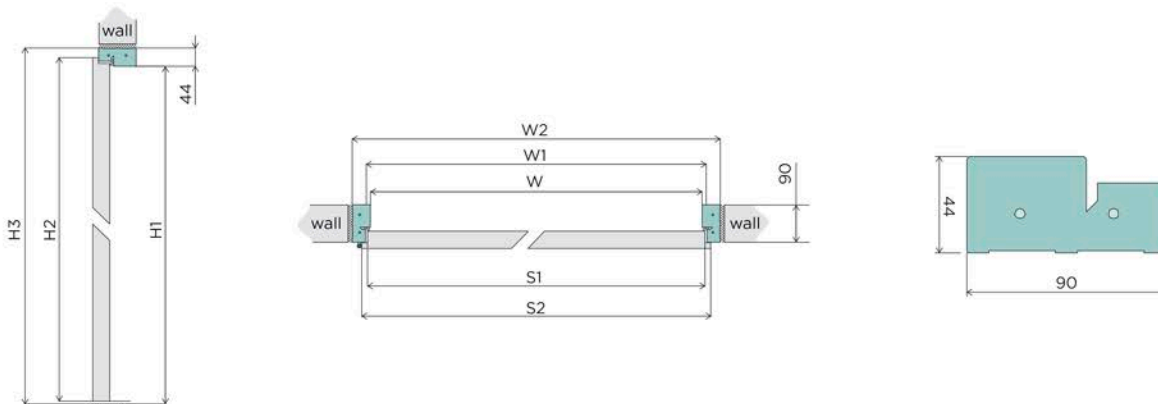

SIZE TABLE

Width	W [mm]	W1 [mm]	W2 [mm]	S1 [mm]	S2 [mm]	H1 [mm]	H2 [mm]	H3 [mm]	Recommended installation opening size mm
60	601	624	689	618	644	2017	2030	2061	710 x 2075
70	701	724	789	718	744				810 x 2075
80	801	824	889	818	844				910 x 2075
90	901	924	989	918	944				1010 x 2075

Each next width class increases the dimensions W, W1, W2, S1 and S2 by 100 mm and is priced the same as a double door frame.

W - frame clear width
 W1 - frame width within rebates
 W2 - overall frame width
 S1 - door leaf width within rebates
 S2 - overall door leaf width
 H1 - frame clear height
 H2 - maximum overall door leaf height
 H3 - overall frame height

FIXED FRAME TIMBER

The fixed timber frame is made from soft wood and with a continual thickness of 90 mm (or 100 mm, for SIMPLE frames). The frames are available in raw timber or finished with a white veneer. A complete frame comprises of a two-piece base rail and a header rail. The frames are available with a rebate or as „tunnel“ frames (no extra charge).

AVAILABLE WIDTH OPTIONS

- 60, 70, 80, 90, other sizes available for an additional charge

FIXTURES

- Mortice-style pintle hinges, 2 pcs. (3 pcs. for a 90 door frame)
- Striker
- Weatherstrip
- Installation hardware

PRICING

Colour group	Price	
	Single doors, 60-90	Double doors, 100-200
PP	£ 155,50	
CPL	£ 142,50	
CLPL	£ 138,00	extra 25%
FF i LAK	£ 127,00	

OPTIONAL

NON-STANDARD WIDTH	ADDITIONAL COST
100 or 110 wide	+ 25%
Non-standard width	£ 26,50

NON-STANDARD HEIGHT	ADDITIONAL COST
Lower height	£ 21,50
≤ 10 mm taller	£ 26,50
Extra hinge	£ 9,00
Extra hinge in the SIMPLE non-rebated system	£ 39,50
Repositioned striker (recommended for non-standard door frame height)	£ 30,50

OTHERS	ADDITIONAL COST
Hinges with 3D adjustment	£ 17,50
Fixed top strike	£ 21,50
Adjustable top strike	£ 30,50
Adjustable bottom strike	£ 30,50
Strip lock strike	£ 39,50
SIMPLE non-rebated frame (44 mm x 100 mm)	£ 87,50
SWINGING door frame	£ 57,00
Folding door frame for FOLD models	£ 52,50
Raw wood door sill with threshold with a seal	£ 39,50
Stainless steel threshold with a seal	£ 35,00
Preparation for electric striker installation	£ 39,50
Preparation for concealed door closer	£ 39,50

COLOURS:

PP GROUP

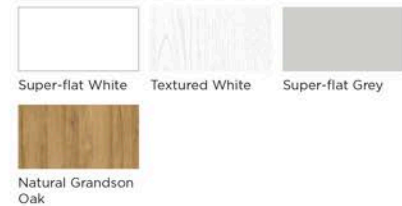

CPL GROUP

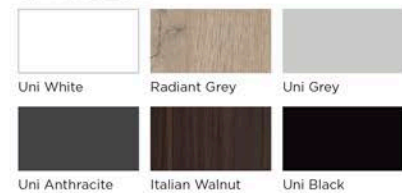

CLPL GROUP



FF GROUP

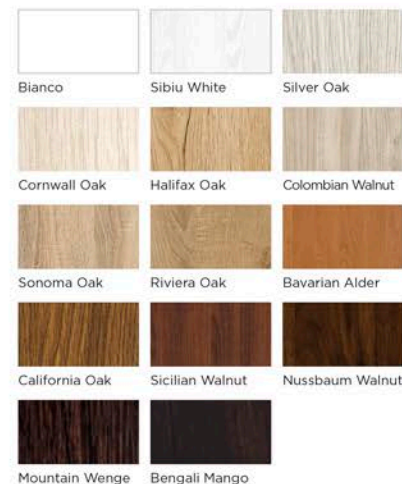

LAK GROUP

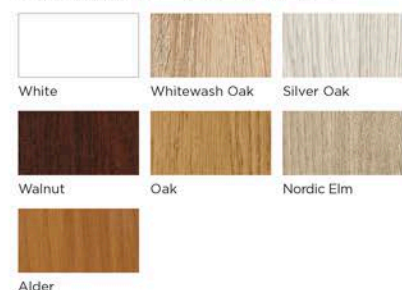

FIXED FRAME MDF



Fixed MDF
„tunnel” frame

DETAILS

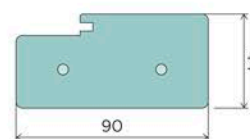
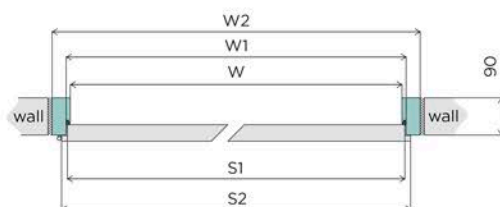
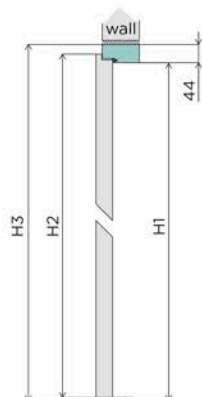

SIZE TABLE

Width	W [mm]	W1 [mm]	W2 [mm]	S1 [mm]	S2 [mm]	H1 [mm]	H2 [mm]	H3 [mm]	Recommended installation opening size, mm
60	603	624	691	618	644				710 x 2075
70	703	724	791	718	744	2019	2030	2063	810 x 2075
80	803	824	891	818	844				910 x 2075
90	903	924	991	918	944				1010 x 2075

Each next width class increases the dimensions W, W1, W2, S1 and S2 by 100 mm and is priced the same as a double door frame.

W - frame clear width
 W1 - frame width within rebates
 W2 - overall frame width
 S1 - door leaf width within rebates
 S2 - overall door leaf width
 H1 - frame clear height
 H2 - maximum overall door leaf height
 H3 - overall frame height

FIXED FRAME MDF

The frame is made from MDF and with a continual thickness of 90 mm (or 100 mm, for SIMPLE frames). A complete frame comprises a two-piece base rail and a header rail. The frames are available with a rebate or as „tunnel“ frames (no extra charge).

AVAILABLE WIDTH OPTIONS

- 60, 70, 80, 90, other sizes available for an additional charge

FIXTURES

- Mortice-style pintle hinges, 2 pcs. (3 pcs. for a 90 door frame)
- Striker
- Weatherstrip
- Installation hardware

PRICING

Colour group	Price	
	Single doors, 60-90	Double doors, 100-200
PP	£ 109,50	
CPL	£ 101,00	extra 25%
CLPL	£ 96,50	
FF i LAK	£ 85,50	

OPTIONAL

NON-STANDARD WIDTH	ADDITIONAL COST
100 or 110 wide	+ 25%
Non-standard width	£ 26,50

NON-STANDARD HEIGHT	ADDITIONAL COST
Lower height	£ 21,50
≤ 10 mm taller	£ 26,50
From 11 mm to 470 mm	£ 61,50
Extra hinge	£ 9,00
Extra hinge in the SIMPLE non-rebated system	£ 39,50
Repositioned striker (recommended for non-standard door frame height)	£ 30,50

OTHERS	ADDITIONAL COST
Hinges with 3D adjustment	£ 17,50
Fixed top strike	£ 21,50
Adjustable top strike	£ 30,50
Adjustable bottom strike	£ 30,50
Strip lock strike	£ 39,50
SIMPLE non-rebated frame (44 mm x 100 mm)	£ 87,50
SWINGING door frame	£ 57,00
Raw wood door sill with threshold with a seal	£ 39,50
Stainless steel threshold with a seal	£ 35,00
Preparation for electric striker installation	£ 39,50
Preparation for concealed door closer	£ 39,50

COLOURS:

GRUPA PP GROUP

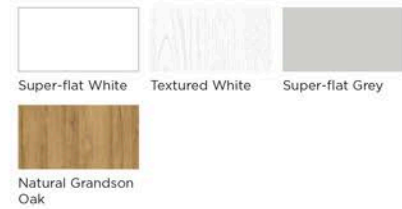

CPL GROUP

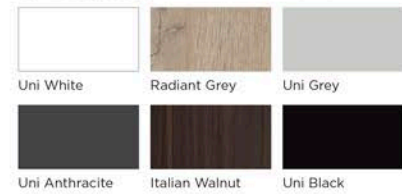

CLPL GROUP

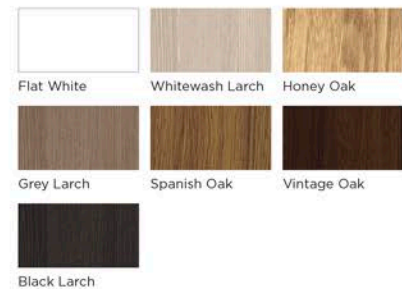

FF GROUP

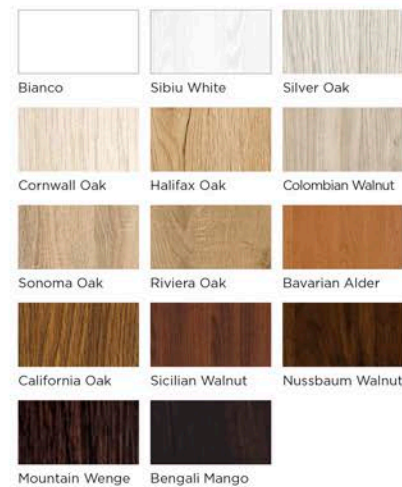

LAK GROUP

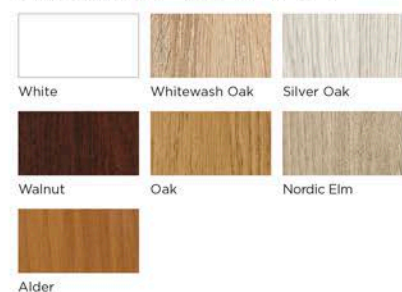

FIXED FRAME ACCESSORIES

60 MM STANDARD EDGING



The standard edging is made from MDF with a fixed width of 60 mm. A complete edging comprises three components: two edging uprights and one edging crossbar.

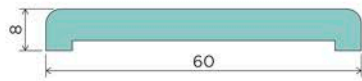

80 MM STANDARD EDGING



The standard edging is made from MDF with a fixed width of 80 mm. A complete edging comprises three components: two uprights and one crosspiece.

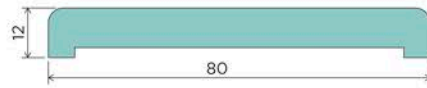

QUARTER



Quarter round moulding is made from MDF with a fixed width of 18 mm. A complete edging comprises three components: two uprights and one crosspiece.

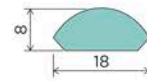

AVAILABLE WIDTH OPTIONS

- 90, other sizes available for an additional charge

PRICING

Colour group	Price					
	60 mm standard edging		80 mm standard edging		Quarter-cylinder	
	Single doors, 60-90	Double doors, 100-200	Single doors, 60-90	Double doors, 100-200	Single doors, 60-90	Double doors, 100-200
PP	£ 27,50	£ 32,00	£ 32,00	£ 36,00	£ 19,50	£ 24,00
CPL	£ 25,0	£ 29,50	£ 29,50	£ 34,00	£ 16,50	£ 21,00
CLPL	£ 24,00	£ 28,50	£ 28,50	£ 32,50	£ 15,00	£ 19,50
FF i LAK	£ 19,50	£ 24,00	£ 24,00	£ 28,50	£ 11,00	£ 15,00

COLOURS:

PP GROUP



CLPL GROUP

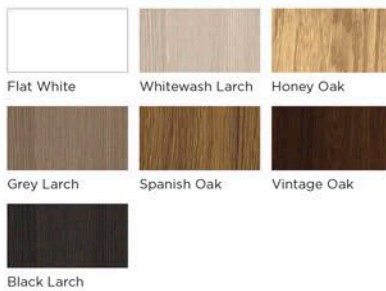

FF GROUP

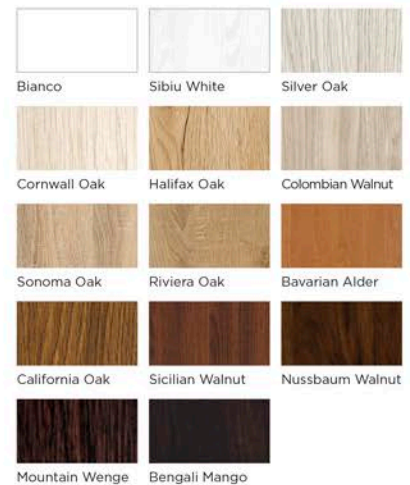

CPL GROUP

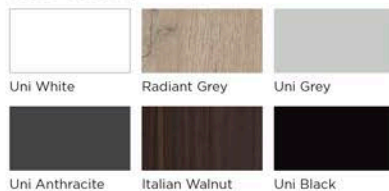

LAK GROUP

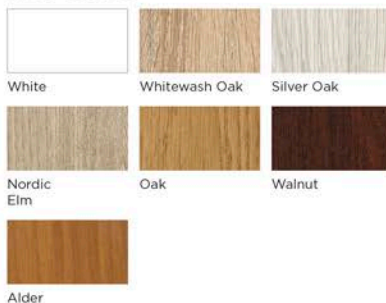

FIXED FRAME ACCESSORIES

TRANSOM WINDOWS



Transom windows and sidelights are made to measure to match the fixed frames ordered. Nonstandard adjustable units can be ordered. Ask for a quote and consult HOMEFE about the manufacturability.

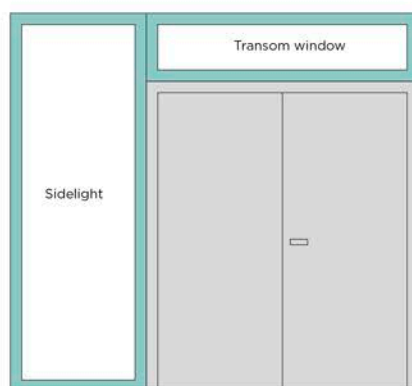

PRICING

Colour group	Price
	1 linear metre of a fixed transom window, glazed with Chinchilla, Satin Deco, Lacomat or Satin Lines
PP	£ 140,50
CPL	£ 129,50
CLPL	£ 127,00
FF i LAK	£ 118,50

Transom windows/ sidelights are available only with tempered glass or VSG 2.21. An additional charge for the selected glass should be added to the price quoted in the price list.

OPTIONAL

Satin tempered glass additional cost (per 1 m2)	£ 65,50
Satin VSG 2.21 glass additional cost (per 1 m2)	£ 83,00

GLAZING TYPES:



COLOURS:

PP GROUP



CPL GROUP

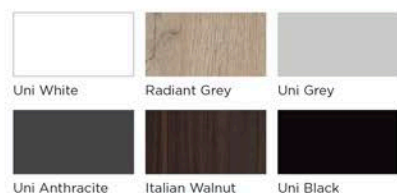

CLPL GROUP

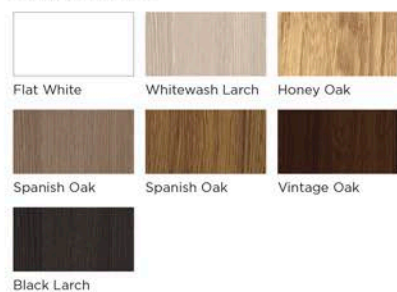

FF GROUP

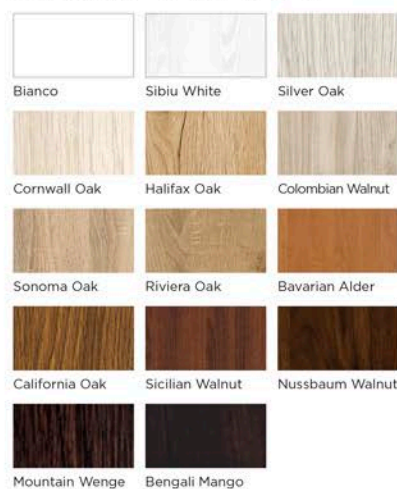

LAK GROUP



ADJUSTABLE FRAME

STEEL FRAME INSTALLATION SYSTEM (ZOS)

UTILITY MODEL NO. 001992199-0001 & 001992199-0002



ZOS combined version



ZOS tunnel version

DETAILS

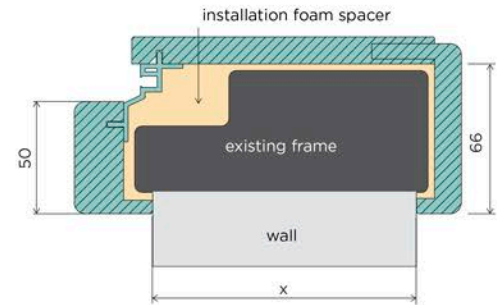
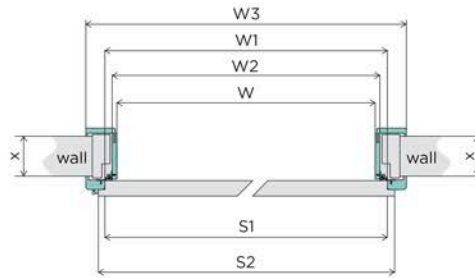
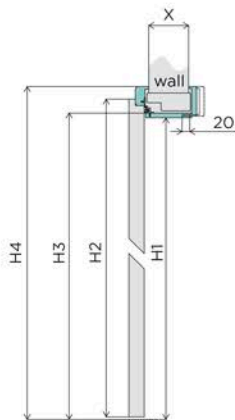

SIZE TABLE

Width	W [mm]	W1 [mm]	W2 [mm]	W3 [mm]	S1 [mm]	S2 [mm]	H1 [mm]	H2 [mm]	H3 [mm]	H4 [mm]	Recommended installation opening width, mm
60	570	626	594	726	618	644					594-600
70	670	726	694	826	718	744					694-700
80	770	826	794	926	818	844	2000	2030	2012	2078	794-800
90	870	926	894	1026	918	944					894-900

Each next width class increases the dimensions W, W1, W2, W3, S1 and S2 by 100 mm and is priced the same as a double door frame.

Adjustment range	X [mm]
60-80	60
80-100	80
100-120	100
120-140	120
X - (X+20)	X

- W - frame clear width
- W1 - frame width within rebates
- W2 - overall frame width
- W3 - frame width with edging
- S1 - door leaf width within rebates
- S2 - overall door leaf width
- H1 - frame clear height
- H2 - maximum overall door leaf height
- H3 - overall frame height
- H4 - frame height with edging

ADJUSTABLE FRAME

STEEL FRAME INSTALLATION SYSTEM (ZOS)

The Steel Frame Installation System (ZOS) is an innovative solution for installation of a new steel frame over the whole existing frame (be it steel, timber or MDF) without having to remove it, to avoid damage to the wall and its cladding (like tiles) and avoid major renovation of the room.



The application of ZOS allows the existing frame and the whole depth of the wall opening to be concealed (including tile cladding) without any risk of damage and without having to install a door leaf narrower than before. If the existing frame holds a 80 cm wide door leaf, the ZOS will accommodate the same door leaf size.

Each ZOS can be adjusted within 20 mm using a moveable angle system. The ZOS are available for 60 mm or thicker walls. Within the adjustment range

between 240-260 mm, the ZOS frames are available in the combined version with a minimum of two parts. For the tunnel ZOS version, the combination is available within the adjustment range of 220-240.

ZOS will only reduce the existing frame inner clearance by 30 mm!

CALCULATING THE ZOS WIDTH:

1. mm (existing frame clear width) - 6 mm (installation clearance) = mm (overall ZOS width)
2. mm (overall ZOS width) + 32 mm = mm (ZOS frame width within rebates)
3. mm (ZOS frame width within rebates) - 56 mm = mm (ZOS clear width)

CALCULATING THE DOOR LEAF WIDTH FOR ZOS:

1. mm (ZOS frame width within rebates) - 8 mm = mm (door leaf width within rebates)
2. mm (door leaf width within rebates) + 26 mm = mm (overall door leaf width)

CALCULATING THE DOOR LEAF HEIGHT FOR ZOS:

1. mm (existing frame clear height) - 3 mm (installation clearance) =
..... mm (overall ZOS height)
2. mm (overall ZOS height) + 16 mm = mm (ZOS frame height within rebates)
3. mm (ZOS frame height within rebates) - 4 mm (door leaf to frame clearance) - 7 mm to 15 mm (door leaf to floor clearance) = mm (door frame height within rebates)
4. mm (door leaf height within rebates) + 13 mm = mm (overall door leaf height)

ADJUSTABLE FRAME

STEEL FRAME INSTALLATION SYSTEM (ZOS)

ZOS STRUCTURE

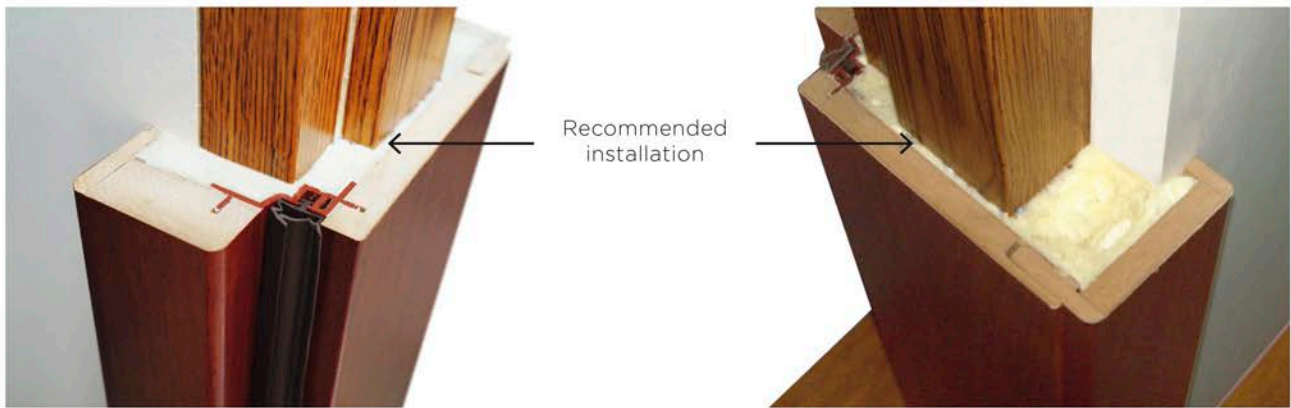
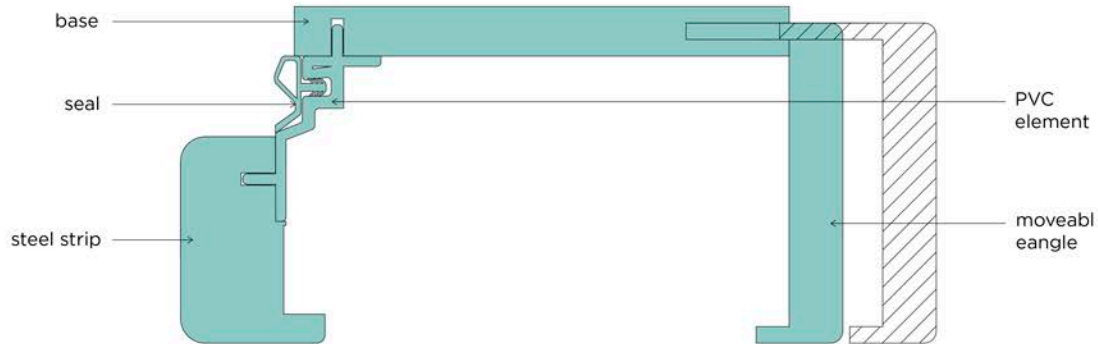

The Steel Frame Installation System (ZOS) provides a solution which avoids any problems caused by non-standard hinge spacing of the existing frame, a non-standard location or size of the strike, or the nonstandard dimensions of rebates. The installation is quick and easy, simply fit the ZOS over the existing frame; you only need to remove hinges if they extend beyond the ZOS trim.

A ZOS frame is available for any clear width. That is why its applications are limitless, even with heavily warped existing frames. The ZOS can level out up to 6 mm in curvature of the existing frame. If the existing frame did not warp or has warped less than 6 mm, the ZOS can be easily installed and accommodate a door leaf. A standard 80 mm ZOS can be installed within the existing frame clearance of between 794 mm and 800 mm.

Any warp curvature above 6 mm will require ordering a custom-sized ZOS. If it is necessary, the door leaf must also match the ordered ZOS.

Another solution for levelling out 6+ mm curves is to remove either of the existing frame posts to facilitate the installation of ZOS and its door leaf.

A ZOS is also available as a „tunnel“ frame. Each door from HOME EFE can be made in a custom size to fit the width and height of your ZOS.

AVAILABLE WIDTH OPTIONS

- 60, 70, 80, 90, other sizes available for an additional charge
- Minimum width W = 500 mm

FIXTURES

- Mortice-style pintle hinges, 2 pcs. (3 pcs. for a 90 door frame)
- Striker
- Weatherstrip
- Installation hardware

ADJUSTABLE FRAME STEEL FRAME INSTALLATION SYSTEM (ZOS)

ZOS, unlike any other HOMEFE frame, can be made to fit any nonstandard width for installation on the existing frame, irrespective of its condition. The 6 mm curvature tolerance is also the recommended installation clearance (with 3 mm per side).

If the existing frame has not warped or has warped less than 3 mm each side, the ZOS can be easily installed and accommodate a door. Measure the clear height and width of the existing frame to verify the feasibility of a ZOS installation.

Measure the clear width in four locations: at the bottom and top hinges, at the lock and at the sill. Measure the clear height in three locations: at each corner and in the centre of the existing width. Also verify whether the existing frame is still perpendicular at the top and bottom corners. This will help verify if the existing frame has warped.

Door handles on long and narrow back plates are recommended for door installed with ZOS. This will help the fit within the clear frame width, which the ZOS reduces by 30 mm and won't require a different door width.

Each ZOS is delivered with a detailed installation manual and specifications of each ZOS component.

FRAME PRICING SINGLE DOORS, 60-90

Adjustment range mm min-max.	Price			
	Colour group			
	PP	CPL	CLPL	FF i LAK
60-80	£ 281,00	£ 267,50	£ 263,50	£ 228,00
80-100				
100-120	£ 232,50	£ 224,00	£ 219,50	£ 188,50
120-140				
140-160	£ 250,00	£ 241,50	£ 237,00	£ 202,00
160-180				
180-200	£ 267,50	£ 254,50	£ 250,00	£ 215,50
200-220				
220-240	£ 281,00	£ 267,50	£ 263,50	£ 228,00
240-260				
260-280	£ 303,00	£ 289,50	£ 285,50	£ 241,50
280-300				
300-320	£ 320,50	£ 307,50	£ 303,00	£ 254,50
320-340				
340-360	£ 333,50	£ 320,50	£ 316,00	£ 267,50
360-380				
380-400	£ 355,00	£ 342,50	£ 338,00	£ 285,50
400-420				
420-440	£ 404,00	£ 382,00	£ 377,50	£ 325,00
440-460				
460-480	£ 448,00	£ 421,50	£ 417,50	£ 364,50
480-500				
500-520	£ 505,00	£ 461,00	£ 456,50	£ 404,00
520-540				
540-560	£ 527,00	£ 500,00	£ 496,00	£ 443,50
560-580				
580-600	£ 562,00	£ 540,00	£ 535,50	£ 483,00
Over 580 mm	Ask for a quote	Ask for a quote	Ask for a quote	Ask for a quote
Moveable angle	£ 39,50	£ 30,50	£ 29,50	£ 26,00
Moveable angle with +20 mm adjustable tongue	£ 52,00	£ 39,50	£ 38,50	£ 35,00

OPTIONAL

NON-STANDARD WIDTH	ADDITIONAL COST
100 or 110 wide	25%
Frame for double door sizes 100-200	25%
Non-standard width	£ 35,00
Non-standard moveable angle width	£ 13,50
NON-STANDARD HEIGHT	ADDITIONAL COST
Shorter height	£ 21,50
Longer up to 45 mm	£ 26,50
Extra hinge	£ 9,00
Repositioned striker (recommended for non-standard door frame height)	£ 30,50
Non-standard moveable angle height	£ 13,50
INNE	ADDITIONAL COST
Raw wood door sill with threshold with a seal	£ 39,50
Stainless steel threshold with a seal	£ 35,00

COLOURS:

PP GROUP

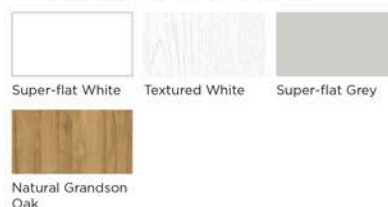

CPL GROUP

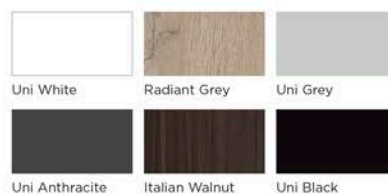

CLPL GROUP

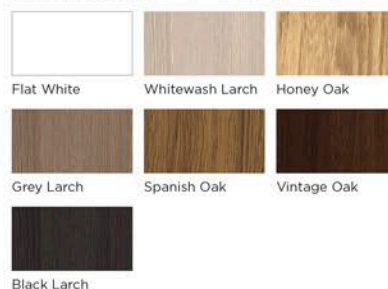

FF GROUP

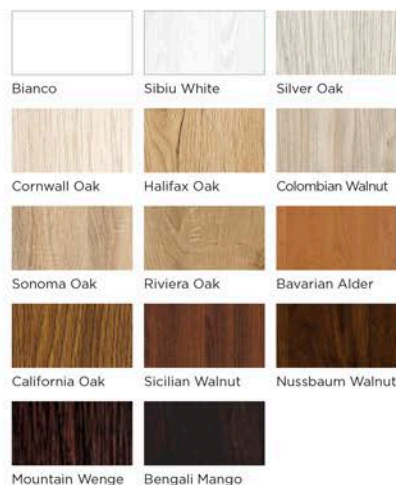

LAK GROUP

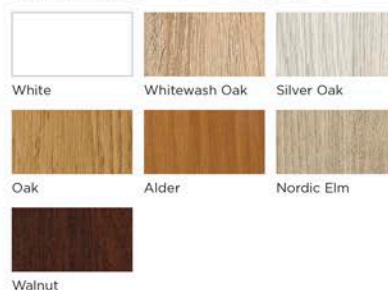

ADJUSTABLE FRAME DIN



SIMPLE
non-rebated
frame



DIN with edging
80 mm



DIN, combined
version



DIN with edging
100 mm



DIN, tunnel
version

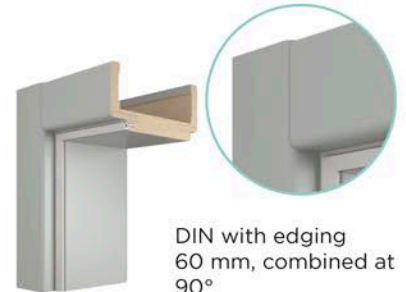

DIN with edging
60 mm, combined at
90°

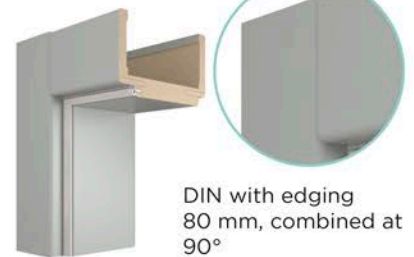

DIN with edging
80 mm, combined at
90°

DETAILS

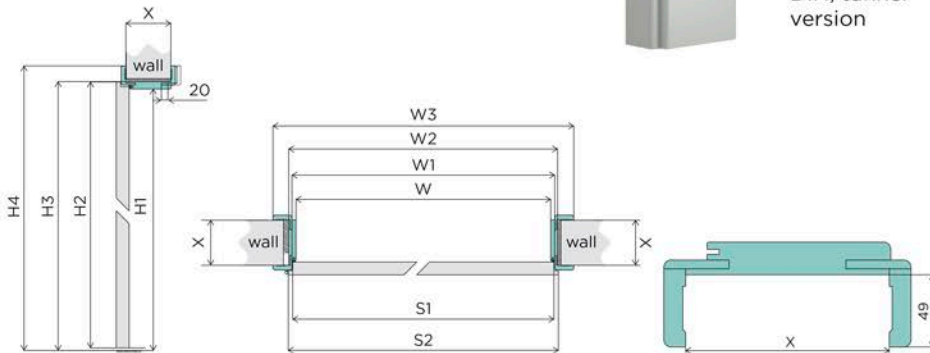

SIZE TABLE

Width	W [mm]	W1 [mm]	W2 [mm]	W3 [mm]	S1 [mm]	S2 [mm]	H1 [mm]	H2 [mm]	H3 [mm]	H4 [mm]	Recommended installation opening size, mm
60	603	624	647	745	618	644					675 x 2055
70	703	724	747	845	718	744					775 x 2055
80	803	824	847	945	818	844	2017	2030	2039	2088	875 x 2055
90	903	924	947	1045	918	944					975 x 2055

Each next width class increases the dimensions W, W1, W2, W3, S1 and S2 by 100 mm and is priced the same as a double door frame..

Adjustment range	X [mm]
60-75	60
80-100	80
100-120	100
120-140	120
X - (X+20)	X

W - frame clear width
 W1 - frame width within rebates
 W2 - overall frame width
 W3 - frame width with edging
 S1 - door leaf width within rebates
 S2 - overall door leaf width
 H1 - frame clear height
 H2 - maximum overall door leaf height
 H3 - overall frame height
 H4 - frame height with edging

ADJUSTABLE FRAME DIN

The adjustable DIN frames are made from MDF and suit any wall thickness from 60 mm up (and from 100 mm up for SIMPLE frames). There is a 20 mm adjustment clearance provided by a moveable angle. Frames are available for any clear width. A complete frame comprises a two-piece base rail and a header rail with angles on both sides. The frames are available with a rebate or as „tunnel“ frames (no extra charge). Within the adjustment range between 280 to 300, the ZOS frames are available in the combined version with a minimum of two parts. For the „tunnel“ frame version, the combination is available within the adjustment range 260-280 mm.

AVAILABLE WIDTH OPTIONS

- 60, 70, 80, 90, other sizes available at extra cost

FIXTURES

- Mortice-style pintle hinges, 2 pcs. (3 pcs. for a 90 door frame)
- Striker
- Weatherstrip
- Installation hardware

PRICING

Adjustment range mm min-max	Price			
	Colour group			
	PP	CPL	CLPL	FF i LAK
60-75	£ 272,00	£ 259,00	£ 254,50	£ 224,00
80-100	£ 197,50	£ 188,50	£ 184,50	£ 136,00
100-120				
120-140				
140-160	£ 219,50	£ 215,00	£ 210,50	£ 171,00
160-180	£ 243,50	£ 237,00	£ 232,50	£ 202,00
180-200				
200-220				
220-240	£ 272,00	£ 259,00	£ 254,50	£ 224,00
240-260	£ 294,00	£ 285,50	£ 284,50	£ 241,50
260-280				
280-300	£ 320,50	£ 307,50	£ 303,00	£ 254,50
300-320				
320-340				
340-360	£ 342,50	£ 333,50	£ 329,00	£ 281,00
360-380	£ 369,00	£ 355,50	£ 351,00	£ 307,50
380-400				
400-420				
420-440	£ 395,00	£ 373,00	£ 369,00	£ 342,50
440-460	£ 430,50	£ 408,50	£ 404,00	£ 377,50
460-480				
480-500				
500-520	£ 465,50	£ 443,50	£ 439,00	£ 412,50
520-540	£ 500,50	£ 478,50	£ 474,00	£ 448,00
540-560				
560-580				
580-600	£ 535,50	£ 513,50	£ 509,50	£ 483,00
Over 580 mm	Ask for a quote	Ask for a quote	Ask for a quote	Ask for a quote
Moveable angle	£ 39,50	£ 30,50	£ 29,50	£ 26,00
Moveable angle with +20 mm adjustable tongue	£ 52,50	£ 39,50	£ 38,50	£ 35,00

OPTIONAL

NON-STANDARD WIDTH	ADDITIONAL COST
100 or 110 wide	25%
Frame for double door sizes 100-200	25%
Non-standard width	£ 35,00
Non-standard moveable angle width	£ 13,50
NON-STANDARD HEIGHT	ADDITIONAL COST
Lower height	£ 21,50
≤ 10 mm taller	£ 27,00
11 mm to 470 mm taller	£ 230,00 (282,90)
Extra hinge	£ 9,00
Extra hinge in the SIMPLE non-rebated system	£ 39,50
Repositioned striker (recommended for non-standard door frame height)	£ 30,50
Non-standard moveable angle height	£ 13,50
OTHER	ADDITIONAL COST
Additional top fixture	£ 21,50
SIMPLE non-rebated frame (for the 100-120 or wider adjustment range)	£ 86,50
Frame for reversible door with 60 mm edging fitted at a 45° angle	£ 109,50
Frame with corner edging, 80 mm height	no charge
Frame with corner edging, 100 mm height	£ 30,50
Frame with components fitted at 90° angle, (not within the scope of regulations 60-75), not applicable for frames with 100 mm corner edging or frames with regulating brush + 20 mm)	£ 26,50
Raw wood threshold with seal	£ 39,50
Stainless steel threshold with seal	£ 30,50
Preparation for electric striker installation	£ 39,50
Preparation for concealed door closer installation	£ 39,50

COLOURS:

PP GROUP

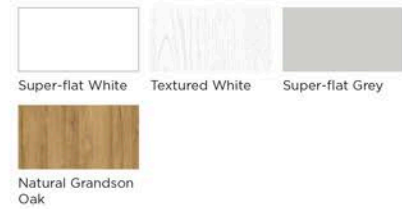

CPL GROUP

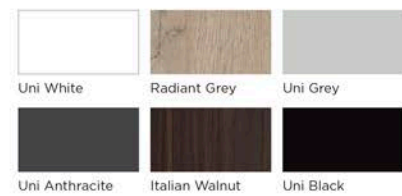

CLPL GROUP

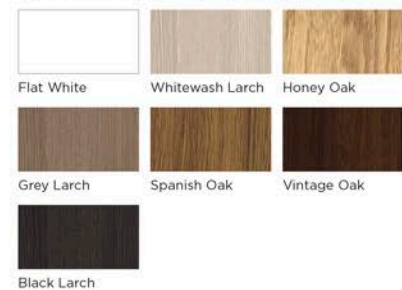

FF GROUP

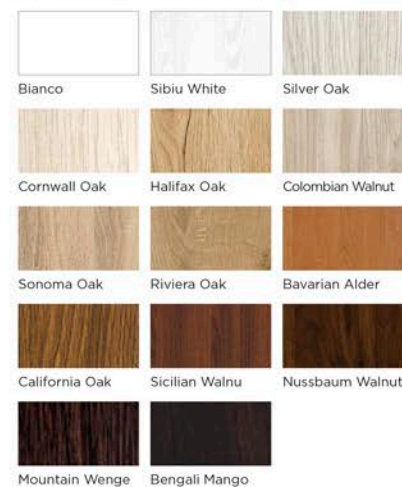

LAK GROUP

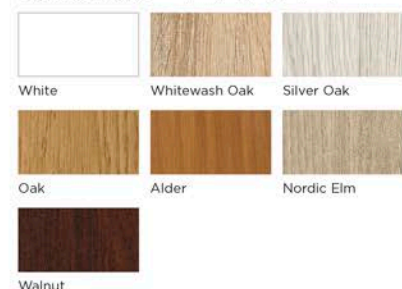

ADJUSTABLE FRAME

DUAL - TWIN-RANGE



DUALE twin-range tunnel frame

DETAILS

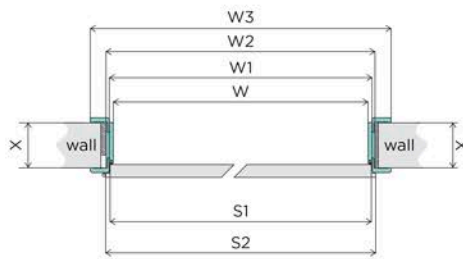
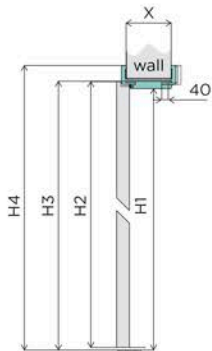

SIZE TABLE

Width	W [mm]	W1 [mm]	W2 [mm]	W3 [mm]	S1 [mm]	S2 [mm]	H1 [mm]	H2 [mm]	H3 [mm]	H4 [mm]	Recommended installation opening size, mm
60	603	624	647	745	618	644	2017	2030	2039	2088	675 x 2055
70	703	724	747	845	718	744					775 x 2055
80	803	824	847	945	818	844					875 x 2055
90	903	924	947	1045	918	944					975 x 2055

Each next width class increases the dimensions W, W1, W2, W3, S1 and S2 by 100 mm and is priced the same as a double door frame.

Adjustment range	X [mm]
100-140	100
140-180	140
180-220	180
220-260	220
260-300	260

- W - frame clear width
- W1 - frame width within rebates
- W2 - outer frame width
- W3 - frame width with edging
- S1 - door leaf width within rebates
- S2 - overall door leaf width
- H1 - frame clear height
- H2 - maximum overall door leaf height
- H3 - overall frame height
- H4 - frame height with edging

ADJUSTABLE FRAME DUAL - TWIN-RANGE

The adjustable DUALE frames are made from MDF and suit any wall thickness from 100 mm up. There is a 40 mm adjustment clearance provided by a moveable angle. The frames are available for any clear width. A complete frame comprises a two-piece base rail and a header rail with angles on both sides. The frames are available with a rebate or as „tunnel“ frames (no extra charge).

AVAILABLE WIDTH OPTIONS

- 60, 70, 80, 90, other sizes available for an additional charge

FIXTURES

- Mortice-style pintle hinges, 2 pcs. (3 pcs. for a 90 door frame)
- Striker
- Weatherstrip
- Installation hardware

PRICING SINGLE DOORS, 60-90

Adjustment range mm min-max.	Price			
	Colour group			
	PP	CPL	CLPL	FF i LAK
100-140	£ 219,50	£ 215,00	£ 210,50	£ 171,00
140-180	£ 243,50	£ 237,00	£ 232,50	£ 202,00
180-220	£ 272,50	£ 259,00	£ 254,50	£ 224,00
220-260	£ 294,00	£ 285,50	£ 284,50	£ 241,50
260-300	£ 320,50	£ 307,50	£ 303,00	£ 254,50

OPTIONAL

NON-STANDARD WIDTH	ADDITIONAL COST
100 or 110 wide	25%
Frame for double door sizes 100-200	25%
Non-standard width	£ 35,00
Non-standard moveable angle width	£ 13,50

NON-STANDARD HEIGHT	ADDITIONAL COST
Lower height	£ 21,50
≤ 10 mm taller	£ 26,50
11 mm to 470 mm taller	£ 101,00
Extra hinge	£ 9,00
Repositioned striker (recommended for non-standard door frame height)	£ 30,50
Non-standard moveable angle height	£ 13,50

OTHER	ADDITIONAL COST
Regular top strike	£ 21,50
Frame with angle edging, 80 mm in overall height	no charge
Frame with angle edging, 100 mm in overall height	£ 30,50
Raw wood door sill with threshold with a seal	£ 39,50
Stainless steel threshold with a seal	£ 35,00

COLOURS:

PP GROUP

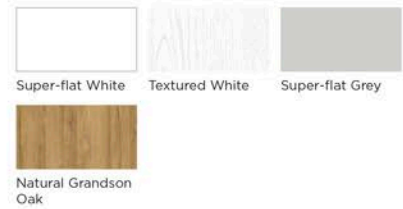

CPL GROUP

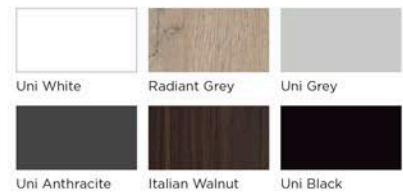

CLPL GROUP

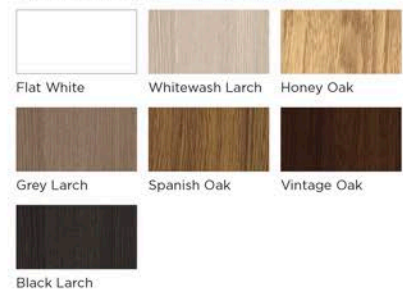

FF GROUP

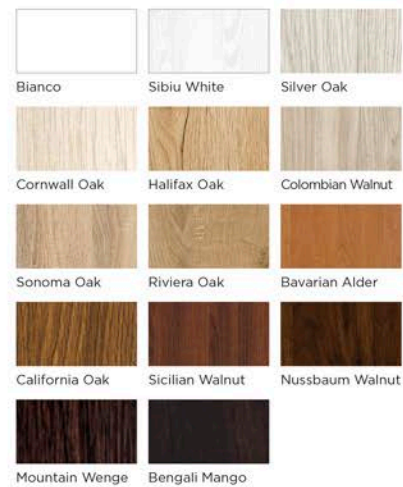

LAK GROUP

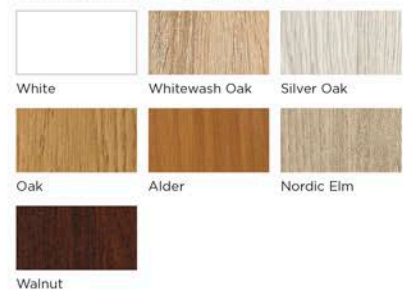

ADJUSTABLE FRAME ACCESSORIES

DIN AND DUALE

DIN PLUS EDGING

The DIN PLUS edging is an ideal solution for quick interior make-overs. It is available in five patterns to suit any kind of interior finish. The DIN PLUS edging is made from MDF with a fixed height of 80 mm. A complete edging system comprises three components: two uprights and one crosspiece. DIN PLUS edging cannot be used with the DIN or DUALE lintel when connected at a right angle.



AVAILABLE WIDTH OPTIONS

- 60, 70, 80, 90, other sizes available for an additional charge

ARTE

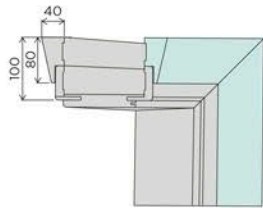

CLASS

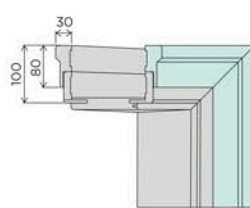

RETRO

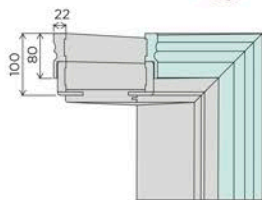

STYLE I

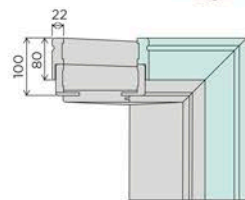

STYLE II

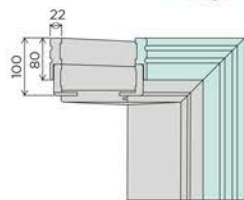

PRICING

Colour group	Price	
	RETRO, STYLE I, STYLE II	ARTE, CLASS
PP	£ 57,00	£ 65,50
CPL	£ 43,50	£ 54,50
CLPL	£ 39,50	£ 48,00
FF i LAK	£ 30,50	£ 39,50

OPTIONAL

NON-STANDARD WIDTH	ADDITIONAL COST
100 or 110 wide	25%
Frame for double doors 100-200	25%
Non-standard width	£ 21,50
DIN PLUS edging for DIN frame with 80 mm or 100 mm edging	£ 21,50
NON-STANDARD HEIGHT	ADDITIONAL COST
Shorter height	£ 21,50
≤ 10 mm taller	£ 21,50
11 mm to 470 mm taller	£ 96,50

COLOURS:

PP GROUP

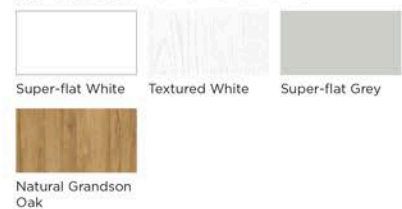

CPL GROUP

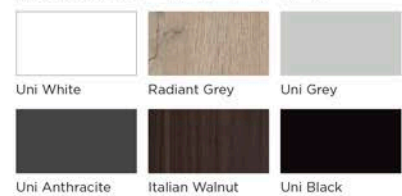

CLPL GROUP

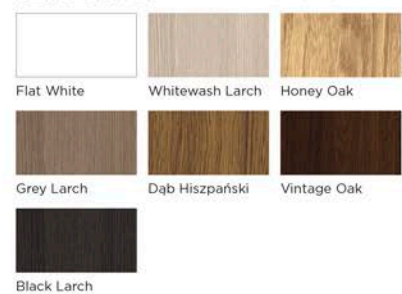

FF GROUP

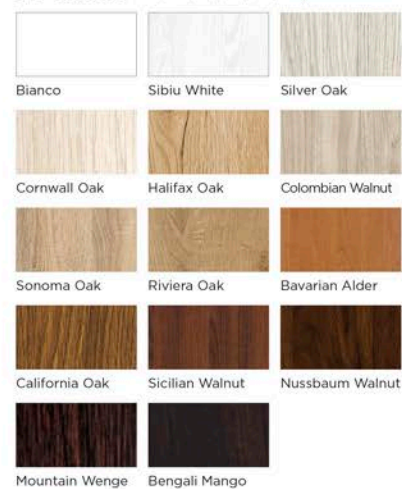

LAK GROUP

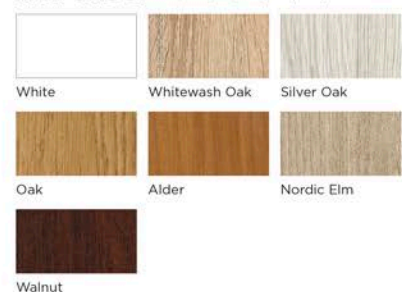

ADJUSTABLE FRAME ACCESSORIES

DIN

The lintel crown is made from MDF with a fixed height of 100 mm. The lintel crown can be fitted on top of an adjustable frame: DIN, DUALE (Does not apply to lintel crowns where the edging parts are connected at a straight angle).

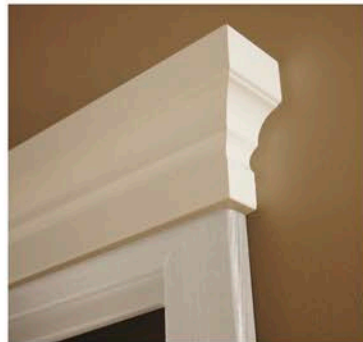
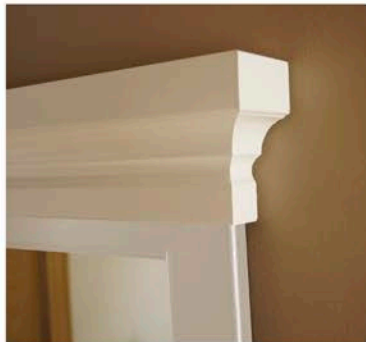
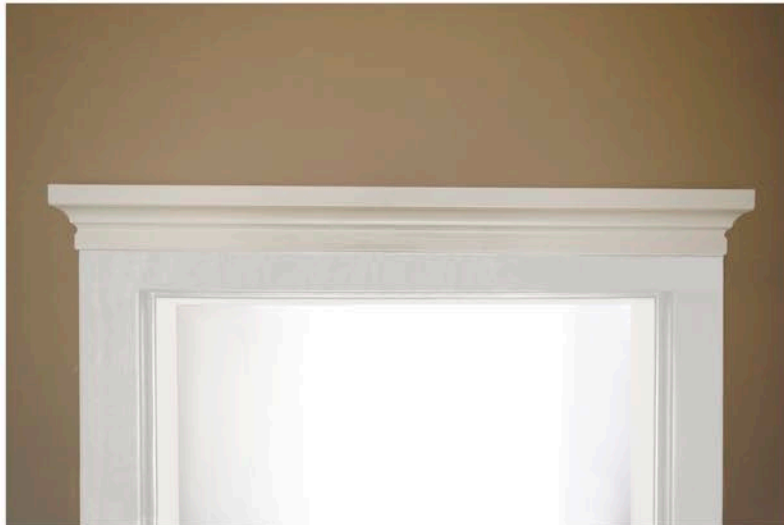

PRICING

Colour group	Price
PP	£ 96,50
CPL	£ 79,00
CLPL	£ 74,50
FF i LAK	£ 57,00

OPTIONAL

100 or 110 wide	25%
Lintel crown for double door sizes 100-200	25%
Non-standard width	£ 21,50

COLOURS:

PP GROUP

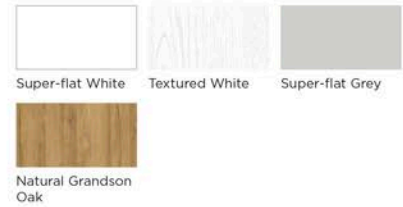

CPL GROUP

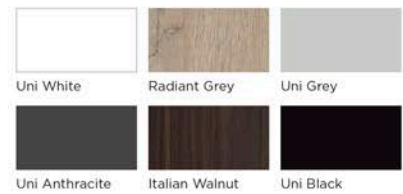

CLPL GROUP

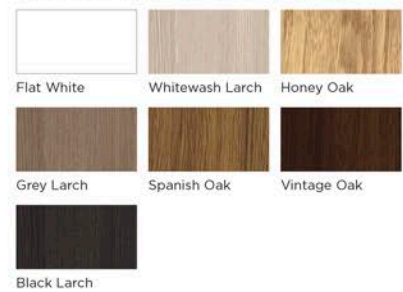

FF GROUP

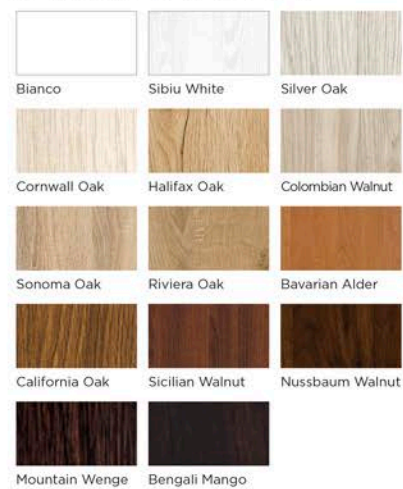

LAK GROUP

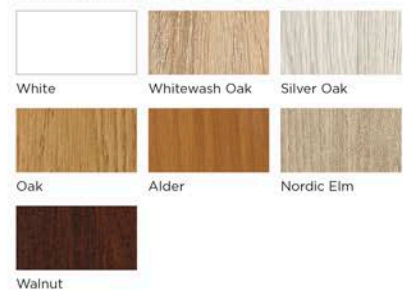

BASEBOARDS

Baseboards made from MDF are available in the standard heights of 80mm, 100mm and 120mm. Other baseboard sizes available for an additional 100% charge. Baseboards are sold in 2000mm wide pieces, cut at an angle of 45 degrees. Baseboards should be mounted using adhesive.

SOFT 01/080, wys. h = 80 mm
SOFT 01/100, wys. h = 100 mm
SOFT 01/120, wys. h = 120 mm



SOFT 04/080, wys. h = 80 mm
SOFT 04/100, wys. h = 100 mm
SOFT 04/120, wys. h = 120 mm



SLANT 02/080, wys. h = 80 mm
SLANT 02/100, wys. h = 100 mm
SLANT 02/120, wys. h = 120 mm



SLANT 03/080, wys. h = 80 mm
SLANT 03/100, wys. h = 100 mm
SLANT 03/120, wys. h = 120 mm



PRICING

Colour group	Price		
	All patterns		
	height 80 mm	height 100 mm	height 120 mm
PP	£ 21,00	£ 21,00	£ 31,50
CPL	£ 19,00	£ 19,00	£ 28,50
CLPL	£ 18,50	£ 18,50	£ 28,00
FF i LAK	£ 14,00	£ 14,00	£ 21,50

OPTIONAL

Baseboard thickness change	+100%
----------------------------	-------

GROUP

PP GROUP



CPL GROUP

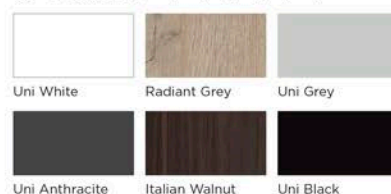

CLPL GROUP

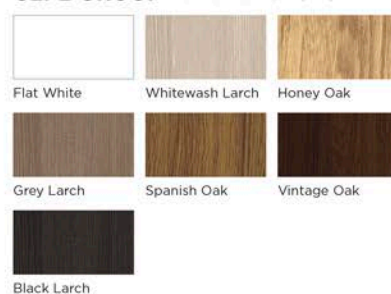

FF GROUP

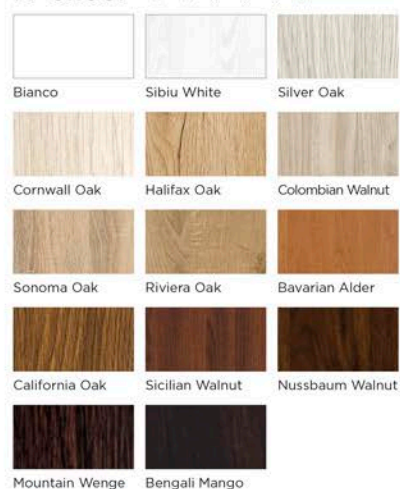

LAK GROUP

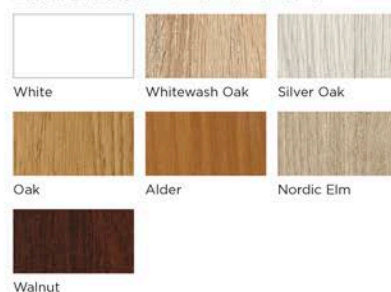

FIXED FRAME STEEL



DETAILS

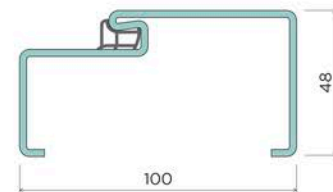
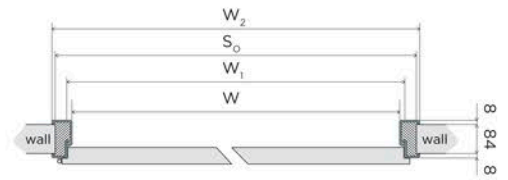
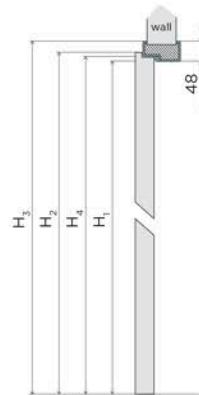

SIZE TABLE

Width	W ₂ [mm]	H ₃ [mm]	W ₁ [mm]	H ₂ H ₄ [mm]	W [mm]	H ₁ [mm]	Recommended installation opening size, mm	
							S ₀ (min)	H ₀ (min)
60	697		627		601		671	
70	797		727		701		771	
80	897		827		801		871	
90	997	2065	927	2030	901	2017	971	2052
100	1097		1027		1001		1071	
110	1197		1127		1101		1171	
120-200	1297-2097		1227-2027		1201-2001		1271-2071	

W₂ - overall frame width
W₁ - frame width within rebates
W - frame clear width
S₀ - clear installation opening width (+10 mm/-0 mm)

H₄ - frame height within rebates
H₃ - overall frame height
H₂ - door leaf height
H₁ - frame clear height

PRICING

Type	Price	
	width: 601, 701, 801, 901	width: 1001, 1101
Rebated	£ 227,50	£ 256,00

OPTIONAL

Reinforced mounting of standard door closer	£ 13,50
Preparation for electric striker installation, complete with lock recess guard and door closer bolster	£ 61,50
Zinc-coated frames	10,00%
GEZE fail-safe electric strike (NO)	£ 70,00
Frame in any other RAL palette colour (not available in live, metallic or pearl colours)	10,00%
Frame in any other RAL palette colour: live, metallic and pearl colours	Ask for a quote

PRODUCTION SPECIFICATION

Structure:

- 1.2 mm sheet steel
- Weatherstrip colour options: white, grey, brown, graphite
- 2 hinges in standard version, 3rd hinge optional w/o extra charge
- The frame is intended for installation in rooms with finished flooring and walls

COLOUR OPTIONS

Surface finish:

- Powder-coated in standard RAL colours which follow: 9010, 9016, 8003, 8017, 7047, 1001, 7024
- other RAL colours available for an RAL additional charge

COLOURS:

RAL



LARGE SLANTED CORNER FRAME STEEL



DETAILS

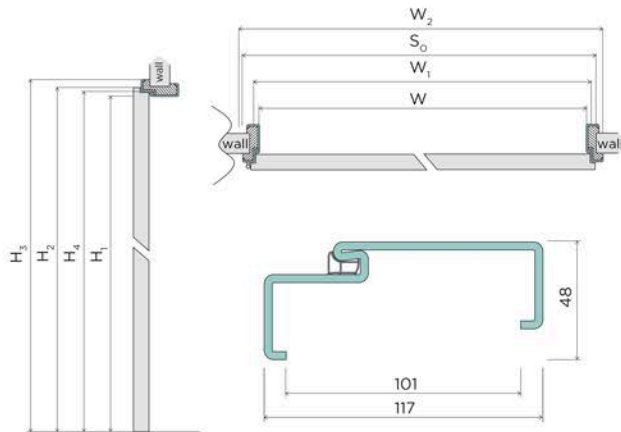

SIZE TABLE

Width	W ₂ [mm]	H ₃ [mm]	W ₁ [mm]	H ₂ H ₄ [mm]	W [mm]	H ₁ [mm]	Recommended installation opening size, mm	
							S ₀ (min)	H ₀ (min)
60	697		627		601		671	
70	797		727		701		771	
80	897		827		801		871	
90	997	2065	927	2030	901	2017	971	2052
100	1097		1027		1001		1071	
110	1197		1127		1101		1171	
120-200	1297-2097		1227-2027		1201-2001		1271-2071	

W₂ - overall frame width
 W₁ - frame width within rebates
 W - frame clear width
 S₀ - clear installation opening width (+10 mm/-0 mm)

H₄ - frame height within rebates
 H₃ - overall frame height
 H₂ - door leaf height
 H₁ - frame clear height

The frames are intended for all room types: at home, public facilities, office premises, hospitality facilities, etc. The frames can be installed in masonry or drywall panel walls of rooms with finished walls and flooring.

PRICING

Type	Price	
	width: 601, 701, 801, 901	width: 1001, 1101
Rebated	£ 227,50	£ 256,00

OPTIONAL

Reinforced mounting of standard door closer	30,00 (36,90)
Preparation for electric striker installation, complete with lock recess guard and door closer bolster	140,00 (172,20)
Zinc-coated frames	10,00%
GEZE fail-safe electric strike (NO)	160,00 (196,80)
Frame in any other RAL palette colour (not available in live, metallic or pearl colours)	10,00%
Frame in any other RAL palette colour: live, metallic and pearl colours	Ask for a quote

PRODUCTION SPECIFICATION

Structure:

- 1.2 mm sheet steel
- Weatherstrip colour options: white, grey, brown, graphite
- 2 hinges in standard version, 3rd hinge optional w/o extra charge
- The frame is intended for installation in rooms with finished flooring and walls

COLOUR OPTIONS

Surface finish:

- Powder-coated in standard RAL colours which follow: 9010, 9016, 8003, 8017, 7047, 1001, 7024
- other RAL colours available for an RAL additional charge

COLOURS:

RAL



ADJUSTABLE FRAME

STEEL

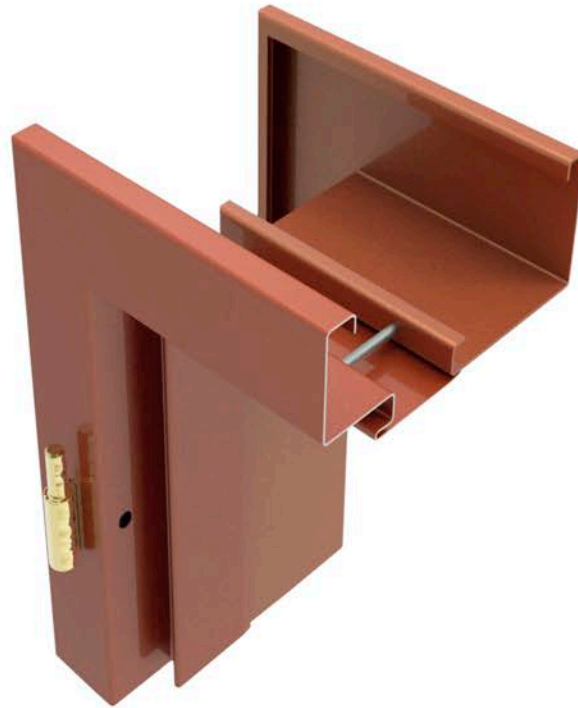

SZCZEGÓŁY

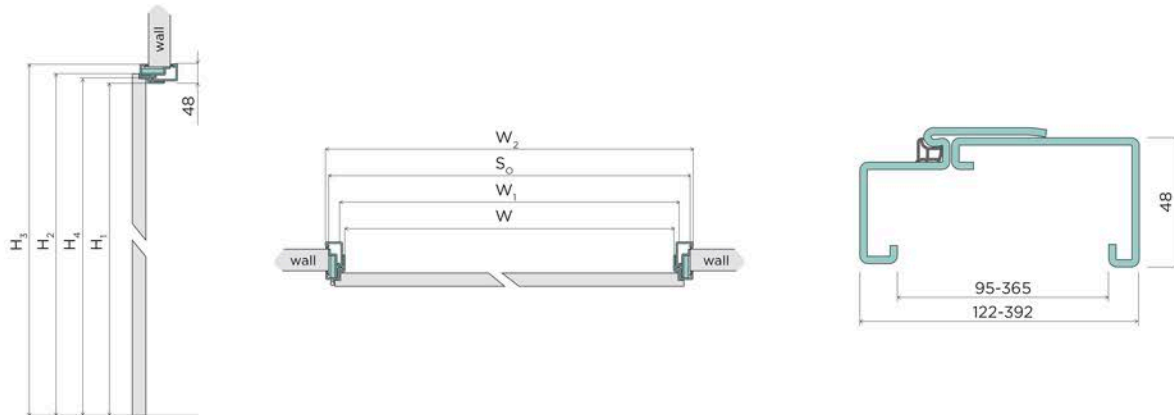

SIZE TABLE

Width	W ₂ [mm]	H ₃ [mm]	W ₁ [mm]	H ₄ [mm]	H ₂ [mm]	W [mm]	H ₁ [mm]	Recommended installation opening size, mm	
								S _{0 (min)}	H _{0 (min)}
60	717		627			601		684	
70	817		727			701		784	
80	917		827			801		884	
90	1017	2078	927	2033	2030	901	2020	984	2061
100	1117		1027			1001		1084	
110	1217		1127			1101		1184	
120-200	1317-2117		1227-2027			1201-2001		1284-2084	

W₂ - overall frame width
W₁ - frame width within rebates
W - frame clear width
S₀ - clear installation opening width (+10 mm/-0 mm)

H₄ - frame height within rebates
H₃ - overall frame height
H₂ - door leaf height
H₁ - frame clear height
H₀ - clear installation opening height (+5 mm/-0 mm)

ADJUSTABLE FRAME STEEL

Steel adjustable frames are intended for installation in all types of rooms with finished flooring and walls, including homes, public facilities and hospitality facilities.

STRUCTURE

- 1.5 mm high-quality sheet steel
- A complete frame includes a base rail and adjustable sections, a weatherstrip, and a set of hinges and blinding plugs
- Weatherstrips available in 3 colour options: white, grey, brown
- 2 hinges in standard version, 3rd hinge optional w/o extra charge

COLOUR OPTIONS

- Powder-coated in standard RAL colours which follow:
- 9010, 9016, 8003, 8017, 7047, 1001, 7024
- other RAL colours available for an additional charge

COLOURS:



PRICING

Adjustment range min - max mm	Price	
	width: 601, 701, 801, 901	width: 1001, 1101
95-125	£ 363,50	£ 429,00
125-155	£ 394,00	£ 460,00
155-185	£ 438,00	£ 532,50
185-215	£ 482,00	£ 548,00
215-245	£ 524,50	£ 590,50
245-275	£ 570,00	£ 636,00
275-305	£ 629,00	£ 695,00
305-335	£ 688,50	£ 754,50
335-365	£ 746,50	£ 812,50

OPTIONAL

Reinforced mounting of standard door closer	£ 13,50
Preparation for electric striker installation, complete with lock recess guard and door closer bolster	£ 61,50
Zinc-coated frames	10,00%
GEZE fail-safe electric striker (NO)	£ 70,00
Frame in any other RAL palette colour (not available in live, metallic or pearl colours)	10,00%
Frame in any other RAL palette colour: live, metallic and pearl colours	Ask for a quote

DOOR HANDLES

SQUARE SEPERATE PLATE

LUNARIA



COLOURS:



Polished Chrome

Satin Chrome

Black



Gold

Flat Gold

Handle plate thickness: 7 mm	Price
Handle piece	£ 169,00
Lower keyhole plate 	£ 35,00
Lower cylinder plate 	£ 35,00
Lower knob plate 	£ 55,50

LILA



COLOURS:



Polished Chrome

Satin Chrome

Black



Gold

Flat Gold

Handle plate thickness: 7 mm	Price
Handle piece	£ 120,50
Lower keyhole plate 	£ 35,00
Lower cylinder plate 	£ 35,00
Lower knob plate 	£ 55,50

WARNA FIT



COLOURS:



Polished Chrome

Satin Chrome

Black

White



Anthracite

Gold

Satin copper

Handle plate thickness: 6 mm	Price
Handle - polished chrome, satin chrome, black, white, anthracite, satin	£ 96,50
Handle - gold, satin copper	£ 127,00
Lower keyhole plate 	£ 35,00
Lower cylinder plate 	£ 35,00
Lower knob plate 	£ 52,50

PYROLA



COLOURS:



Polished Chrome

Brushed Chrome



Black

Gold

Handle plate thickness: 7 mm	Price
Handle piece	£ 94,00
Lower keyhole plate 	£ 30,50
Lower cylinder plate 	£ 30,50
Lower knob plate 	£ 50,50

SPYQ



COLOURS:



Chrome

Satin Chrome



Black

Handle plate thickness: 10 mm	Price
Handle piece	£ 98,50
Lower keyhole plate 	£ 30,50
Lower cylinder plate 	£ 30,50
Lower knob plate 	£ 43,50

SEMPRE



COLOURS:



Chrome

Satin Chrome



Black

Handle plate thickness: 10 mm	Price
Handle - chrome, satin chrome	£ 74,50
Handle - black	£ 105,00
Lower keyhole plate 	£ 30,50
Lower cylinder plate 	£ 30,50
Lower knob plate 	£ 43,50

DOOR HANDLES

ZOE FIT



COLOURS:



Chrome



Satin Chrome



Black

Handle plate thickness:
6 mm **Price**

Handle piece £ 107,00

Lower keyhole plate  £ 35,00

Lower cylinder plate  £ 35,00

Lower knob plate  £ 48,00

DOPPIO



COLOURS:



Satin chrome complete with 2 inserts: white and black



Anthracite complete with 2 inserts: white and black

Handle plate thickness:
6 mm **Price**

Handle piece £ 74,00

Lower keyhole plate  £ 26,50

Lower cylinder plate  £ 26,50

Lower knob plate  £ 90,00 (110,70)

NESH Q



COLOURS:



Chrome



Satin Chrome



Black

Handle plate thickness:
10 mm **Price**

Handle piece £ 81,00

Lower keyhole plate  £ 30,50

Lower cylinder plate  £ 30,50

Lower knob plate  £ 43,50

LASER SI



COLOURS:



Flat chrome



Polished Chrome

Handle plate thickness:
7 mm **Price**

Handle piece £ 57,00

Lower keyhole plate  £ 19,50

Lower cylinder plate  £ 19,50

Lower knob plate  £ 28,50

FOSTER BI



COLOURS:



Flat chrome



Polished Chrome



Nickel matt



White



Black

Handle plate thickness:
10 mm **Price**

Handle piece £ 32,50

Lower keyhole plate  £ 13,50

Lower cylinder plate  £ 13,50

Lower knob plate  £ 15,00

EUFORIO



COLOURS:



Black

Handle plate thickness:
10 mm **Price**

Handle piece £ 30,50

Lower keyhole plate  £ 15,00

Lower cylinder plate  £ 15,00

Lower knob plate  £ 21,50

DOOR HANDLES

SQUARE SEPERATE PLATE

CASCADA



COLOURS:



Brushed Nickel



Vintage Brass

Handle plate thickness: 11 mm		Price
Handle piece		£ 30,50
Lower keyhole plate		£ 11,00
Lower cylinder plate		£ 11,00
Lower knob plate		£ 16,50

ARCO



COLOURS:



Satin Graphite



Brushed Nickel



Vintage Brass

Handle plate thickness: 11 mm		Price
Handle piece		£ 28,50
Lower keyhole plate		£ 11,00
Lower cylinder plate		£ 11,00
Lower knob plate		£ 16,

IRIS



COLOURS:



Brushed Nickel



Vintage Brass

Handle plate thickness: 11 mm		Price
Handle piece		£ 30,50
Lower keyhole plate		£ 11,00
Lower cylinder plate		£ 11,00
Lower knob plate		£ 16,50

FIRE DOOR SQUARE SEPERATE PLATE

When ordering fire door handles, the door depth should be specified to obtain the appropriate hardware for installation.

KVADRAT 1701 FIRE



KVADRAT 1702 FIRE



KVADRAT 1703 FIRE





KVADRAT 1704 FIRE



COLOURS:



Stainless steel

Handle plate thickness: 9 mm		Price
Handle type 1701		£ 30,50
Handle type 1702		£ 41,50
Handle type 1703		£ 37,00
Handle type 1704		£ 31,50
Lower keyhole plate		£ 10,50
Lower cylinder plate		£ 10,50
Lower knob plate	   	£ 28,50

SQUARE KNOBS

Q FIT



COLOURS:

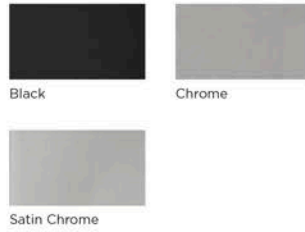

Handle plate thickness: 10 mm	Price
Knob	£ 74,50
Lower keyhole plate 	£ 35,00
Lower cylinder plate 	£ 35,00
Lower knob plate 	£ 48,00

ROUND SEPERATE PLATE

AZALIA



COLOURS:



Handle plate thickness 7 mm	Price
Colour:	
Polished chrome, brushed chrome, black	Gold, flat gold, copper
Handle piece	£ 94,00 £ 114,00
Lower keyhole plate 	£ 28,50 £ 32,50
Lower cylinder plate 	£ 28,50 £ 32,50
Lower knob plate 	£ 48,00 £ 57,00

LUNA



COLOURS:





Handle plate thickness 7 mm	Price
Colour:	
Polished chrome, brushed chrome, black	Gold
Handle piece	£ 83,00 £ 92,00
Lower keyhole plate 	£ 28,50
Lower cylinder plate 	£ 28,50
Lower knob plate 	£ 48,50

KALMIA



COLOURS:



Handle plate thickness 7 mm	Price
Colour:	
Polished chrome, brushed chrome, black, gold	
Handle piece	£ 85,50
Lower keyhole plate 	£ 28,50
Lower cylinder plate 	£ 28,50
Lower knob plate 	£ 48,50

DOOR HANDLES

ROUND SEPERATE PLATE

NESH FIT



COLOURS:



Chrome

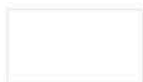

White



Black

Handle plate thickness: 10 mm		Price
Handle piece		£ 109,50
Lower keyhole plate		£ 35,00
Lower cylinder plate		£ 35,00
Lower knob plate		£ 48,00

OLEANDRO



COLOURS:



Polished
Chrome



Brushed
Chrome



Black

Handle plate thickness: 7 mm		Price
Handle piece		£ 70,00
Lower keyhole plate		£ 28,50
Lower cylinder plate		£ 28,50
Lower knob plate		£ 48,00

FRAGOLA



COLOURS:



Polished
Chrome



Brushed
Chrome



Black

Handle plate thickness: 7 mm		Price
Handle piece		£ 70,00
Lower keyhole plate		£ 28,50
Lower cylinder plate		£ 28,50
Lower knob plate		£ 48,00

MIRIAM SI



COLOURS:



Polished
Chrome



Brushed
Chrome



Gold

Handle plate thickness: 7 mm		Price
Handle piece		£ 62,00
Lower keyhole plate		£ 18,50
Lower cylinder plate		£ 18,50
Lower knob plate		£ 29,50

ARIANNA SI



COLOURS:



Polished
Chrome



Brushed
Chrome



Black

Handle plate thickness: 7 mm		Price
Handle piece		£ 62,00
Lower keyhole plate		£ 18,50
Lower cylinder plate		£ 18,50
Lower knob plate		£ 29,50

VOLATIS



COLOURS:



Brushed
Nickel



Vintage
Brass

Handle plate thickness: 11 mm		Price
Handle piece		£ 25,00
Lower keyhole plate		£ 9,00
Lower knob plate		£ 9,00
Lower knob plate		£ 14,00

DOOR HANDLES

ROUND SEPERATE PLATE

CLASSICO



COLOURS:



Brushed Nickel

Vintage Brass

Handle plate thickness: 11 mm		Price
Handle piece		£ 24,50
Lower keyhole plate		£ 9,00
Lower cylinder plate		£ 9,00
Lower knob plate		£ 14,00

ADULAR



COLOURS:



Brushed Nickel

Vintage Brass

Handle plate thickness: 11 mm		Price
Handle piece		£ 21,50
Lower keyhole plate		£ 9,00
Lower cylinder plate		£ 9,00
Lower knob plate		£ 14,00

ROUND KNOBS

FIT



COLOURS:



Black

Chrome



Satin Chrome

Handle plate thickness: 6 mm		Price
Knob		£ 74,50
Lower keyhole plate		£ 35,00
Lower cylinder plate		£ 35,00
Lower knob plate		£ 48,00

FIRE DOOR ROUND SEPERATE PLATE

When ordering fire door handles, the door depth should be specified to obtain the appropriate hardware for installation.

OVAL 1701 FIRE



COLOURS:



Stainless steel

OVAL 1702 FIRE



Handle plate thickness: 9 mm

Price

Handle type OVAL 1701

£ 28,50

Handle type OVAL 1702

£ 43,00

Handle type OVAL 1704

£ 28,50

Lower keyhole plate



£ 6,50

Lower knob plate



£ 6,50

Lower knob plate



£ 21,50

OVAL 1704 FIRE



DOOR HANDLES

SINGLE LONG PLATE

FIRE DOOR LONG

OLARIX 72 **FIRE**



COLOURS:



Stainless steel

Handle plate thickness: 8 mm	Price
Keyhole handle	£ 48,00
Cylinder handle	£ 48,00
Bolt knob handle	£ 70,00

ADULAR DS



COLOURS:



Brushed
Nickel



Vintage
Brass

Handle plate thickness: 9,5 mm	Price
Keyhole handle	£ 21,50
Cylinder handle	£ 21,50
Bolt knob handle	£ 26,50

ARCO DS



COLOURS:



Brushed
Nickel



Vintage
Brass

Handle plate thickness: 9,5 mm	Price
Keyhole handle	£ 26,50
Cylinder handle	£ 26,50
Bolt knob handle	£ 31,00

IRIS DS



COLOURS:



Brushed
Nickel



Vintage
Brass

Handle plate thickness: 9,5 mm	Price
Keyhole handle	£ 28,50
Cylinder handle	£ 28,50
Bolt knob handle	£ 33,00

CASCADA DS



COLOURS:



Brushed
Nickel



Vintage
Brass

Handle plate thickness: 10 mm	Price
Keyhole handle	£ 29,00
Cylinder handle	£ 29,00
Bolt knob handle	£ 37,00

ENTRANCE HANDLES

LAMBDA



COLOURS:

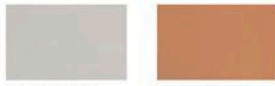

Stainless steel Vintage metal

Spacing:
72 mm

Anti-burglar class:
CLASS I Price

Handle plate thickness:
8 mm

Handle piece	£ 61,50
Top plate	£ 20,00

TOTAL



COLOURS:



Stainless steel

Spacing: 72 mm

Handle plate thickness: 8 mm

	Price	
	Anti-burglar class:	
	I CLASS	III CLASS
Handle piece	£ 79,00	£ 79,00
Top plate	£ 43,00	£ 70,00

When ordering external door handles it is necessary to specify a direction. The handle direction is according to the direction of the door when opening to the exterior.

HAGA PLUS



COLOURS:



inox titanium Black

Spacing: 72 mm

ANTI-BURGLARY
CLASS NONE Price

Handle plate thickness:
8 mm

	COLOUR:	
	inox, titanium	Black
Handle piece	£ 87,50	£ 101,00
Top plate	£ 35,00	£ 39,50

ROYAL FLEX



COLOURS:



inox titanium Black

Spacing: 72 mm

ANTI-BURGLARY
CLASS III Price

Handle plate thickness:
12 mm

	COLOUR:	
	inox, titanium	Black
Handle piece	£ 180,00	£ 202,00
Top plate	£ 101,00	£ 112,00

PRESTIGE FLEX



COLOURS:



inox titanium Black

Spacing: 72 mm

ANTI-BURGLARY
CLASS III Price

Handle plate thickness:
12 mm

	COLOUR:	
	inox, titanium	Black
Handle piece	£ 180,00	£ 202,00
Top plate	£ 101,00	£ 112,00

ACCESSORIES

HOMEFEE CLEANER

A professional kit for the cleaning, care and reconditioning of door surfaces

The PREMIUM DOOR CARE includes 2 products, 250 ml each: Homeefe Door Cleaner and Homeefe Door Refresher.



PRICING

PREMIUM DOOR CARE	Price / set
Homeefe Door Cleaner 250 ml	£ 41,50
Homeefe Door Refresher 250 ml	

ELECTRIC STRIKES AND DOOR



GR200



ITS96



DES7



DES7 SLIM



PPOŽ. 447
FIRE

PRICING

TYPE	COLOUR	FIRE EXIT	Max. door leaf weight	Max. door leaf width	Price
Surface mounted door closer, Groom 200, w/scissor arm	Silver, white or brown	yes	100 kg	1250 mm	£ 114,00
Surface mounted door closer, Groom 200, w/scissor arm and retention	Silver, white or brown	no	100 kg	1250 mm	£ 162,50
Surface mounted door closer, Groom 200 for double doors	Silver, white or brown	yes	100 kg	1250 mm	£ 434,50
Flush door closer, ITS96, track-mounted (LH or RH version)	Silver	yes	130 kg	1100 mm	£ 373,00
Flush door closer, ITS96 GSR, track-mounted, for double doors with sequence selectors	Silver	yes	130 kg	1100 mm, minimum 70	£ 1 186,00
Electric striker, DES7, symmetric, fail-safe (NO), 12 V	Silver	no	n/a	n/d	£ 79,00
Electric striker, DES7 SLIM, symmetric, fail-safe (NO), for double doors, 12 V	Silver	no	n/a	n/a	£ 153,50
Fire-exit electric striker, 447 FIRE, 6-12 V, 12 V or 24 V	Silver	yes	n/a	n/a	£ 527, 00



WEATHERSTRIPPING

PRICING

TYPE	Price / meter
For fixed and adjustable frames (does not fit ZOS) White, beige or brown	£ 2.50
For adjustable ZOS frames White, beige or brown	£ 5.50
For fender beams, clear	£ 6.00

FREE-STANDING DOOR STOPS



PRICING

COLOUR	Price	
	LOW	TALL
Nickel, vintage metal, black	£ 20,00	£ 20,00

EURO PROFILE CYLINDERS (also for fire doors)

COLOURS:

- brass
- nickel



PRICING

TYPE	Price	
	NO KNOB	WITH KNOB
25/25	£ 14,00	-
28/36	£ 17,50	£ 24,00
30/30	£ 17,50	£ 22,50
30/40	£ 21,50	£ 26,50
30/45	£ 22,00	£ 28,00
30/50	£ 24,00	£ 29,50
30/60	£ 27,00	-
35/30	£ 19,00	£ 24,50
35/35	£ 21,50	£ 26,50
35/40	£ 22,00	£ 28,00
35/45	£ 24,00	£ 29,50
35/50	£ 25,50	£ 31,00
35/55	£ 27,00	£ 31,00
40/40	£ 24,00	£ 29,50
40/50	£ 27,00	£ 33,00
45/45	£ 27,00	£ 33,00
45/55	£ 30,50	£ 36,00

SINGLE KEY SYSTEM CYLINDER SET

IN A SET:

- 2 insert
- 5 individually numbers keys

COLOURS:

- brass
- nickel



PRICING

SIZE	Price
	DOUBLE INSERT SET
26/45+G26/45 Wilka B	£ 114,00
26/45+G45/26 Wilka B	£ 114,00
30/35+G30/35	£ 56,00
30/35+G35/30	£ 56,00
30/40+G30/40	£ 59,00
30/40+G40/30	£ 59,00
30/45+G30/45	£ 61,50
30/45+G45/30	£ 61,50
35/40+G35/40	£ 61,50
35/40+G40/35	£ 61,50
40/40+G40/40	£ 52,00
40/45+G40/45	£ 52,00
Other sizes	Individual pricing

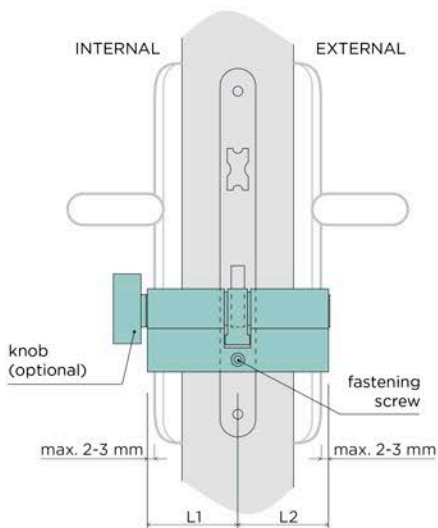

SYMBOLS:

L1 - length from the centre of the handle to the edge of the external plate
L2 - width from the centre of the handle to the edge of the external plate

- Insert axis indicates that the fastening screw visible for every door from the face of the door
- The insert length should be such that on each side of the door it doesn't protrude more than 3mm. If deciding to purchase an insert with knob, remember to specify which side of the door it will be situated.

ACCESSORIES

LOCKS



Key operated

Lock for Euro profile cylinders

Lock with forced operator

Bottom bolt lock with a cylinder insert



Top bolt lock with a cylinder insert

Hook bolt lock, w/round plate

Hook bolt lock, w/square plate

PRICING

TYPE	Price
Lock, key-operated, with a blocking option or Euro profile cylinder; white zinc	£ 9,00
Lock, key-operated, with a blocking option or Euro profile cylinder; nickel	£ 13,50
Lower 3 pin lock with Euro profile cylinder	£ 22,00
Upper 3 pin lock with Euro profile cylinder	£ 17,50
Hook bolt lock, key-operated or Euro profile cylinder	£ 65,50
Hook bolt lock, with a blocking option	£ 74,50
magnetic lock	£ 26,50

It is possible to order a hook lock in the required handle colour for an 30% additional charge to the standard matt chrome lock cost.

200° FOV SPYHOLE



Chrome

Ground stainless steel

Satin chrome

Satin nickel

Brass

Vintage metal

White

Flat Black

PRICING

COLOUR	Price
Chrome, ground stainless steel, satin chrome, satin nickel, brass, vintage metal, white, flat black	£ 39,50

HINGE COVERS



PRICING

COLOUR	Price 1 set (2 pcs.)
Bronze, varnished chrome, satin chrome, brass, nickel, black	£ 4,00

Available sizes: Ø 15, Ø 16, Ø 20.

HANDLES

U010K ROUND



PRICING

COLOUR	Price
matt chrome, polished chrome, black, patina, polished gold, matt gold	£ 17,50

U03KW SQUARE



PRICING

COLOUR	Price
matt chrome, polished chrome, black, patina, polished gold, matt gold	£ 17,50

U020W OVAL



PRICING

COLOUR	Price
matt chrome, polished chrome, black, patina, polished gold, matt gold	£ 35,00

U04PR RECTANGULAR



PRICING

COLOUR	Price
matt chrome, polished chrome, black, patina, polished gold, matt gold	£ 35,00

BLACK TOPCOAT FOR LOFT 32X228 (PIECE)



PRICING

COLOUR	Price
COLOUR	£ 17,50

FLUSH PULL

P050K CIRCLE



PRICING

COLOUR	Price
matt chrome, polished chrome, black, patina, polished gold, matt gold	£ 39,50

P06KW SQUARE

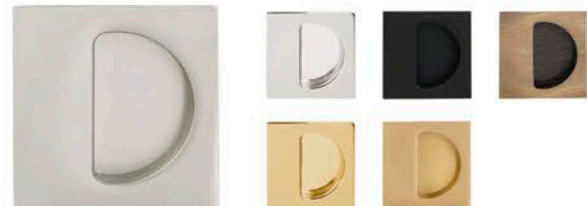

PRICING

COLOUR	Price
matt chrome, polished chrome, black, patina, polished gold, matt gold	£ 39,50

SPECIFICATIONS

DOOR LEAF REBATED DOOR LEAF

VENTILATION

In order to provide sufficient ventilation (0,022 m²) in bathroom doors we recommend one of the following:

- use ventilation sleeves as well as sufficient clearance between the door and floor level, depending on the width of the door.
- use a ventilation cut as well as sufficient clearance between the door and floor level, depending on the width of the door.
- use ventilation grilles

Factory fitted ventilation may prevent later self-shortening of doors. For doors of height H2 = 1980 mm or less, the door shape may prevent the installation of ventilation grilles.

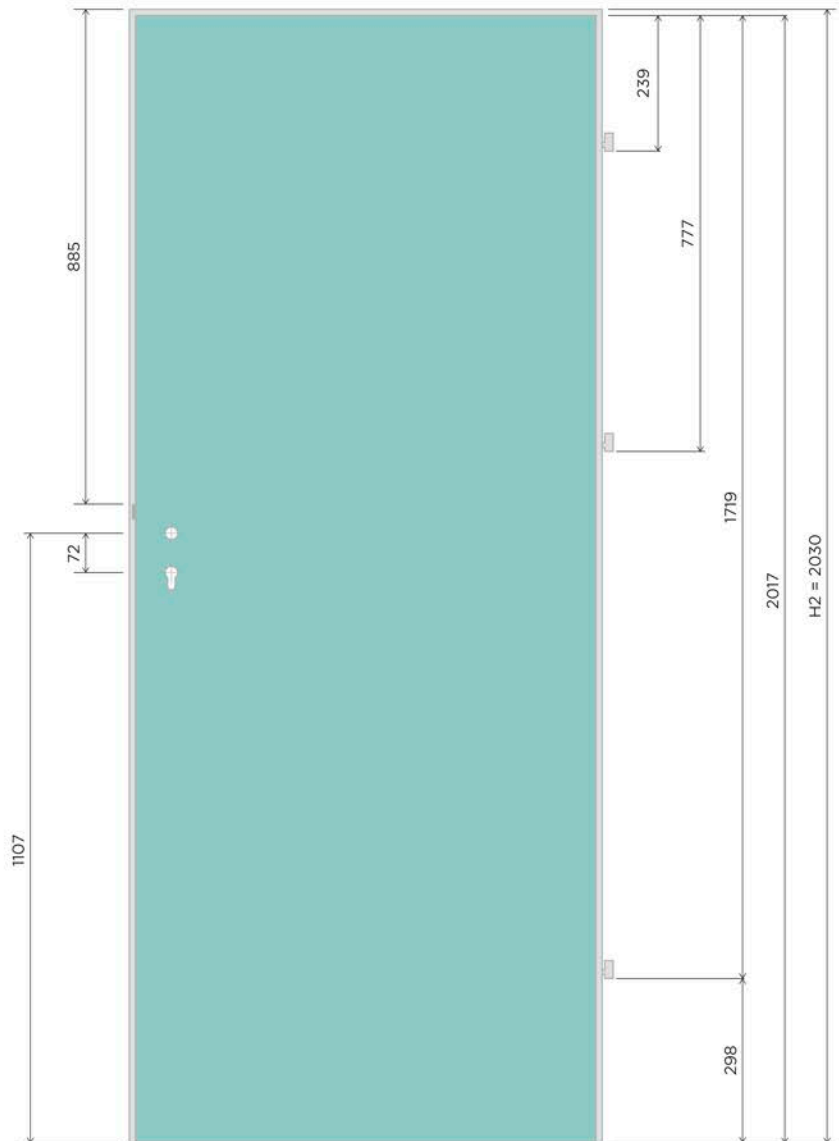

Door leaf	Door leaf width within rebates S1, mm	Maximum overall door leaf width S2, mm
60	618	644
70	718	744
80	818	844
90	918	944
100	1018	1044

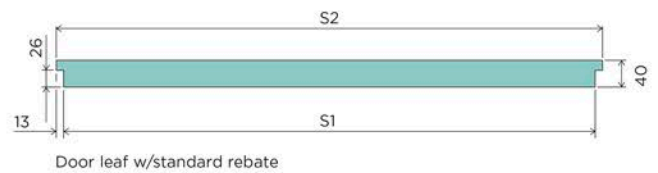

NOTE!

The finish and structure of the door leaf allow for on-site trimming of the height from the bottom by no more than 60 mm with timber door leaves or 30 mm with MDF door leaves. Do not attempt to trim the height of a double door or sliding non-rebate door.

SPECIFICATIONS

SIZES: INTERNAL DOORS

SINGLE-LEAF

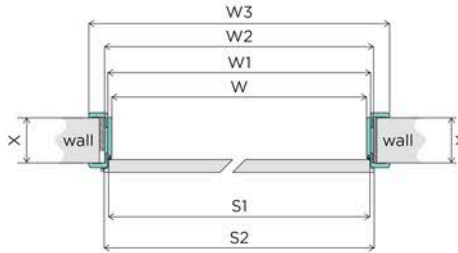

INTERNAL DOORS WITH FIXED FRAMES

	Rozmiar	W [mm]	W1 [mm]	W2 [mm]	S1 [mm]	S2 [mm]	H1 [mm]	H2 [mm]	H3 [mm]	W0 [mm]	H0 [mm]
Fixed, MDF	60	603	624	691	618	644	2019	2030	2063	710	2075
	70	703	724	791	718	744				810	
	80	803	824	891	818	844				910	
	90	903	924	991	918	944				1010	
	100	1003	1024	1091	1018	1044				1110	
	110	1103	1124	1191	1118	1144				1210	
Fixed, timber	60	601	624	689	618	644	2017	2030	2061	710	2075
	70	701	724	789	718	744				810	
	80	801	824	889	818	844				910	
	90	901	924	989	918	944				1010	
	100	1001	1024	1089	1018	1044				1110	
	110	1101	1124	1189	1118	1144				1210	

INTERNAL DOORS WITH ADJUSTABLE FRAMES

	Rozmiar	W [mm]	W1 [mm]	W2 [mm]	W3 [mm] 60/80/100*	S1 [mm]	S2 [mm]	H1 [mm]	H2 [mm]	H3 [mm]	H4 [mm] 60/80/100*	W0 [mm]	H0 [mm]
Steel Frame Installation System (ZOS)	60	570	626	594	726	618	644	2000	2030	2012	2078	594-600	2020
	70	670	726	694	826	718	744					694-700	
	80	770	826	794	926	818	844					794-800	
	90	870	926	894	1026	918	944					894-900	
	100	970	1026	994	1126	1018	1044					994-1000	
	110	1070	1126	1094	1226	1118	1144					1094-1100	
Adjustable DIN & DUALE frames	60	603	624	647	745/785/825	618	644	2017	2030	2039	2088/2108/2128	675	2055
	70	703	724	747	845/885/925	718	744					775	
	80	803	824	847	945/985/1025	818	844					875	
	90	903	924	947	1045/1085/1125	918	944					975	
	100	1003	1024	1047	1145/1185/1225	1018	1044					1075	
	110	1103	1124	1147	1245/1285/1325	1118	1144					1175	

LEGEND:

- W - frame clear width
- W1 - frame width within rebates
- W2 - overall frame width
- W3 - frame width with edging (*for DIN frames, the width is specified plus 60 mm, 80 mm or 100 mm edging)
- S1 - door leaf width
- S2 - overall door leaf width
- H1 - frame clear height
- H2 - door leaf height
- H3 - overall frame height
- H4 - frame height with edging (*for DIN frames, the height is specified plus 60 mm, 80 mm or 100 mm edging)
- W0 - recommended installation opening width
- H0 - recommended installation opening height

SPECIFICATIONS

SIZES: INTERNAL DOORS

DOUBLE-LEAF

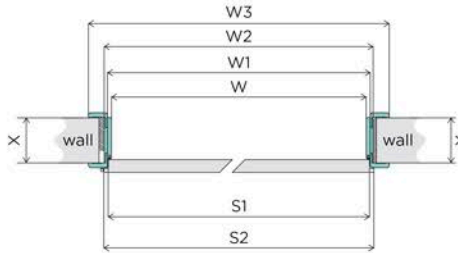

INTERNAL DOUBLE DOORS WITH FIXED FRAMES

	Size	W [mm]	W1 [mm]	W2 [mm]	S2 [mm]	H1 [mm]	H2 [mm]	H3 [mm]	W0 [mm]	HO [mm]
Fixed, MDF	60+60	1203	1224	1291	644+610				1310	
	70+60	1303	1324	1391	744+610				1410	
	70+70, 80+60	1403	1424	1491	744+710, 844+610				1510	
	90+60, 80+70	1503	1524	1591	944+610, 844+710	2019	2030	2063	1610	2075
	80+80, 90+70	1603	1624	1691	844+810, 944+710				1710	
	90+80	1703	1724	1791	944+810				1810	
	90+90	1803	1824	1891	944+910				1910	
Fixed, timber	60+60	1201	1224	1289	644+610				1310	
	70+60	1301	1324	1389	744+610				1410	
	70+70, 80+60	1401	1424	1489	744+710, 844+610				1510	
	90+60, 80+70	1501	1524	1589	944+610, 844+710	2017	2030	2061	1610	2075
	80+80, 90+70	1601	1624	1689	844+810, 944+710				1710	
	90+80	1701	1724	1789	944+810				1810	
	90+90	1801	1824	1889	944+910				1910	

INTERNAL DOUBLE DOORS WITH ADJUSTABLE FRAMES

	Size	W [mm]	W1 [mm]	W2 [mm]	W3 [mm] 60/80/100*	S2 [mm]	H1 [mm]	H2 [mm]	H3 [mm]	H4 [mm] 60/80/100*	W0 [mm]	HO [mm]
Steel Frame Installation System (ZOS)	60+60	1170	1226	1194	1326	644+610					1194-1200	
	70+60	1270	1326	1294	1426	744+610					1294-1300	
	70+70, 80+60	1370	1426	1394	1526	744+710, 844+610					1394-1400	
	90+60, 80+70	1470	1526	1494	1626	944+610, 844+710	2000	2030	2012	2078	1494-1500	2020
	80+80, 90+70	1570	1626	1594	1726	844+810, 944+710					1594-1600	
	90+80	1670	1726	1694	1826	944+810					1694-1700	
	90+90	1770	1826	1794	1926	944+910					1794-1800	
Adjustable DIN & DUALE frames	60+60	1203	1224	1247	1345/1385/1425	644+610					1275	
	70+60	1303	1324	1347	1445/1485/1525	744+610					1375	
	70+70, 80+60	1403	1424	1447	1545/1585/1625	744+710, 844+610					1475	
	90+60, 80+70	1503	1524	1547	1645/1685/1725	944+610, 844+710	2017	2030	2039	2088/2108/2128	1575	2055
	80+80, 90+70	1603	1624	1647	1745/1785/1825	844+810, 944+710					1675	
	90+80	1703	1724	1747	1845/1885/1925	944+810					1775	
	90+90	1803	1824	1847	1945/1985/2025	944+910					1875	

LEGEND:

- W - frame clear width
- W1 - frame width within rebates
- W2 - overall frame width
- W3 - frame width with edging (*for DIN frames, the width is specified plus 60 mm, 80 mm or 100 mm edging)
- S2 - overall door leaf width
- H1 - frame clear height
- H2 - door leaf height
- H3 - overall frame height
- H4 - frame height with edging (*for DIN frames, the height is specified plus 60 mm, 80 mm or 100 mm edging)
- W0 - recommended installation opening width
- HO - recommended installation opening height

SPECIFICATIONS

SIZES: SWING DOORS

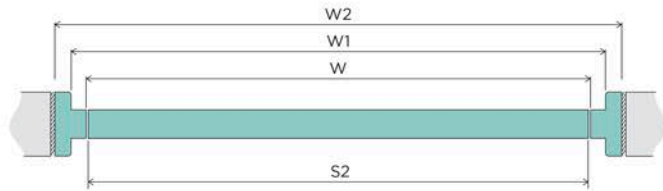

SINGLE SWING DOORS

	Size	W [mm]	W1 [mm]	W2 [mm]	S2 [mm]	H1 [mm]	H2 [mm]	H3 [mm]	W0 [mm]	H0 [mm]
Fixed, MDF	60	603	624	691	591	2019	2005	2063	710	2075
	70	703	724	791	691				810	
	80	803	824	891	791				910	
	90	903	924	991	891				1010	
Fixed, timber	60	601	624	689	589	2017	2005	2061	710	2075
	70	701	724	789	689				810	
	80	801	824	889	789				910	
	90	901	924	989	889				1010	

DOUBLE SWING DOORS

	Size	W [mm]	W1 [mm]	W2 [mm]	S2 [mm]	H1 [mm]	H2 [mm]	H3 [mm]	W0 [mm]	H0 [mm]
Fixed, MDF	60	603	624	691	584 (292+292)	2019	2005	2063	710	2075
	70	703	724	791	684 (342+342)				810	
	80	803	824	891	784 (392+392)				910	
	90	903	924	991	884 (442+442)				1010	
	100	1003	1024	1091	984 (492+492)				1110	
	110	1103	1124	1191	1084 (542+542)				1210	
	120	1203	1224	1291	1184 (592+592)				1310	
	130	1303	1324	1391	1284 (642+642)				1410	
	140	1403	1424	1491	1384 (692+692)				1510	
	150	1503	1524	1591	1484 (742+742)				1610	
	160	1603	1624	1691	1584 (792+792)				1710	
	170	1703	1724	1791	1684 (842+842)				1810	
Fixed, timber	60	601	624	689	582 (291+291)	2017	2005	2061	710	2075
	70	701	724	789	682 (341+341)				810	
	80	801	824	889	782 (391+391)				910	
	90	901	924	989	882 (441+441)				1010	
	100	1001	1024	1089	982 (491+491)				1110	
	110	1101	1124	1189	1082 (541+541)				1210	
	120	1201	1224	1289	1182 (591+591)				1310	
	130	1301	1324	1389	1282 (641+641)				1410	
	140	1401	1424	1489	1382 (691+691)				1510	
	150	1501	1524	1589	1482 (741+741)				1610	
	160	1601	1624	1689	1582 (791+791)				1710	
	170	1701	1724	1789	1682 (841+841)				1810	
180	1801	1824	1889	1782 (891+891)	1910					

LEGEND:

- W - frame clear width
- W1 - frame width within rebates
- W2 - overall frame width
- W3 - frame width with edging (*for DIN frames, the width is specified plus 60 mm, 80 mm or 100 mm edging)
- S2 - overall door leaf width
- H1 - frame clear height
- H2 - door leaf height
- H3 - overall frame height
- H4 - frame height with edging (*for DIN frames, the height is specified plus 60 mm, 80 mm or 100 mm edging)
- W0 - recommended installation opening width
- H0 - recommended installation opening height

SPECIFICATIONS
 SIZES: **FOLD**
FOLDING DOORS

FOLD SINGLE FOLDING DOORS

	Size	W [mm]	W2 [mm]	S2 [mm]	H1 [mm]	H2 [mm]	H3 [mm]	W0 [mm]	H0 [mm]
Fixed, timber	60	601	689	309+309	2017	1995	2061	710	2075
	70	701	789	359+359				810	
	80	801	889	409+409				910	
	90	901	989	459+459				1010	
	100	1001	1089	509+509				1110	

FOLD DOUBLE FOLDING DOORS

	Size	W [mm]	W2 [mm]	S2 [mm]	H1 [mm]	H2 [mm]	H3 [mm]	W0 [mm]	H0 [mm]
Fixed, timber	110	1101	1189	(277+277)×2	2017	1995	2061	1210	2075
	120	1201	1289	(302+302)×2				1310	
	130	1301	1389	(327+327)×2				1410	
	140	1401	1489	(352+352)×2				1510	
	150	1501	1589	(377+377)×2				1610	
	160	1601	1689	(402+402)×2				1710	
	170	1701	1789	(427+427)×2				1810	
	180	1801	1889	(452+452)×2				1910	

SPECIFICATIONS

SIZES: **SIMPLE NON-REBATED DOORS**

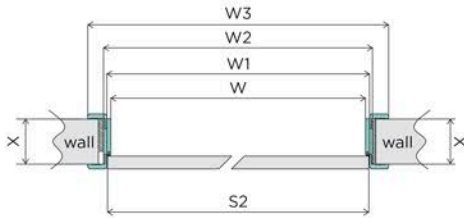

SIMPLE NON-REBATED INTERNAL DOORS WITH FIXED FRAMES

	Size	W [mm]	W1 [mm]	W2 [mm]	S2 [mm]	H1 [mm]	H2 [mm]	H3 [mm]	W0 [mm]	H0 [mm]
Fixed, MDF	60	603	624	691	618				710	
	70	703	724	791	718				810	
	80	803	824	891	818	2019	2017	2063	910	2075
	90	903	924	991	918				1010	
	100	1003	1024	1091	1018				1110	
Fixed, timber	60	601	624	689	618				710	
	70	701	724	789	718				810	
	80	801	824	889	818	2017	2017	2061	910	2075
	90	901	924	989	918				1010	
	100	1001	1024	1089	1018				1110	

SIMPLE NON-REBATED INTERNAL DOORS WITH ADJUSTABLE FRAMES

	Size	W [mm]	W1 [mm]	W2 [mm]	W3 [mm] 60/80/100*	S2 [mm]	H1 [mm]	H2 [mm]	H3 [mm]	H4 [mm] 60/80/100*	W0 [mm]	H0 [mm]
Adjustable DIN frame	60	603	624	647	745/785/825	618					675	
	70	703	724	747	845/885/925	718					775	
	80	803	824	847	945/985/1025	818	2017	2017	2039	2088/2108/2128	875	2055
	90	903	924	947	1045/1085/1125	918					975	
	100	1003	1024	1047	1145/1185/1225	1018					1075	

LEGEND:

- W - frame clear width
- W1 - frame width within rebates
- W2 - overall frame width
- W3 - frame width with edging (*for DIN frames, the width is specified plus 60 mm, 80 mm or 100 mm edging)
- S2 - overall door leaf width
- H1 - frame clear height
- H2 - door leaf height
- H3 - overall frame height
- H4 - frame height with edging (*for DIN frames, the height is specified plus 60 mm, 80 mm or 100 mm edging)
- W0 - recommended installation opening width
- H0 - recommended installation opening height

SPECIFICATIONS

SIZES: **SIMPLE NON-REBATED DOORS**

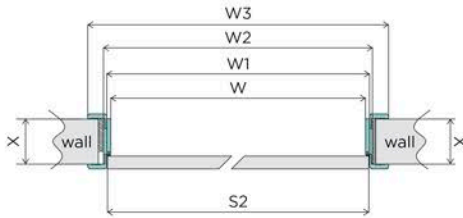

INTERNAL DOUBLE DOORS WITH FIXED FRAMES

	Size	W [mm]	W1 [mm]	W2 [mm]	S2 [mm]	H1 [mm]	H2 [mm]	H3 [mm]	W0 [mm]	H0 [mm]
Fixed, MDF	60+60	1237	1258	1325	631+631	2019	2017	2063	1345	2075
	70+60	1337	1358	1425	731+731				1445	
	70+70, 80+60	1437	1458	1525	731+731, 831+631				1545	
	90+60, 80+70	1537	1558	1625	931+631, 831+731				1645	
	80+80, 90+70	1637	1658	1725	831+831, 931+731				1745	
	90+80	1737	1758	1825	931+831				1845	
	90+90	1837	1858	1925	931+931				1945	
Fixed, timber	60+60	1235	1258	1323	631+631	2017	2017	2061	1345	2075
	70+60	1335	1358	1423	731+731				1445	
	70+70, 80+60	1435	1458	1523	731+731, 831+631				1545	
	90+60, 80+70	1535	1558	1623	931+631, 831+731				1645	
	80+80, 90+70	1635	1658	1723	831+831, 931+731				1745	
	90+80	1735	1758	1823	931+831				1845	
	90+90	1835	1858	1923	931+931				1945	

INTERNAL DOUBLE DOORS WITH ADJUSTABLE FRAMES

	Size	W [mm]	W1 [mm]	W2 [mm]	W3 [mm] 60/80/100*	S2 [mm]	H1 [mm]	H2 [mm]	H3 [mm]	H4 [mm] 60/80/100*	W0 [mm]	H0 [mm]
Adjustable DIN frame	60+60	1237	1258	1281	1379/1419/1459	631+631	2017	2017	2039	2088/2108/2128	1300	2055
	70+60	1337	1358	1381	1479/1519/1559	731+631					1400	
	70+70, 80+60	1437	1458	1481	1579/1619/1659	731+731, 831+631					1500	
	90+60, 80+70	1537	1558	1581	1679/1719/1759	931+631, 831+731					1600	
	80+80, 90+70	1637	1658	1681	1779/1819/1859	831+831, 931+731					1700	
	90+80	1737	1758	1781	1879/1919/1959	931+831					1800	
	90+90	1837	1858	1881	1979/2019/2059	931+931					1900	

LEGEND:

- W - frame clear width
- W1 - frame width within rebates
- W2 - overall frame width
- W3 - frame width with edging (*for DIN frames, the width is specified plus 60 mm, 80 mm or 100 mm edging)
- S2 - overall door leaf width
- H1 - frame clear height
- H2 - door leaf height
- H3 - overall frame height
- H4 - frame height with edging (*for DIN frames, the height is specified plus 60 mm, 80 mm or 100 mm edging)
- W0 - recommended installation opening width
- H0 - recommended installation opening height

BASIC STANDARD 01 LOFT, PVC Grey Supermat





17 High Street
Rushden, NN10 0QU
Northamptonshire

Call our Sales Advisors
T: 01933 413 817
T: 07483 391 546
E: info@homeefe.co.uk
www.homeefe.co.uk

