



Homeefe

DOORS • WINDOWS • FLOORING

WOODEN DOORS



BEHIND EVERY DOOR THERE IS A HOME

Contents:

Introduction	2
Standard door options and optional extras	3
Care Products	3 / 61
Construction of Frame-and-Panel doors	4
Construction of Panel doors	5
SPECIAL OFFERS	6
LOFT Panel doors	8
FIORD Panel doors.....	16
GLASS Panel doors.....	28
INOX Panel doors.....	36
INOX 3D Panel doors.....	42
FUTURE Panel doors.....	44
ZEBRANO Panel doors.....	50
FRAME-AND-PANEL doors	52
FUTURE RP Panel doors.....	60
EARTHQUAKE Panel doors.....	61
Additions and transoms	62
Door handles and dedicated fittings	64
Door handle operation and selection	65
Equipment	66
Handles and Cylinders	68
Glazing	70

About us

25 years of experience, highly recommended and an individual approach to each and every client are just a few of our company's strengths. Our doors are produced with great care and their joinery is characterised by excellent durability and high thermal insulation, all of which is proven through testing and in practice. Our state-of-the-art machinery and our vast experience in joinery allow us to produce pragmatic solutions to match our clients visual and technical needs and expectations. Homeefe's doors are versatile as they are suitable for modern buildings as well as country and town houses. Every product that leaves our production line is certified and approved for use in construction. All elements used in the production of our products come from reputable sources, which ensures their durability.

Why choose Homeefe doors?

Our doors are made of highly durable wood: pine with a 5.5mm oak veneer or 100% oak. Using properly dried plywood prevents the structure from warping even after many years of use. Ensuring adequate preservation of our wood during the production process protects and ensures the longevity of our products. We offer a wide range of colours: the full RAL palette and a choice of stains and varnishes, meaning all our clients can be sure to find the door they want. We even offer the option of two-colour painting for your chosen door. Our products compliment any building facade. The variety of styles that we offer and the option to individually design your door makes every door purchased from us unique. Our catalogue offers over 1000 models, which you can adapt to your own preferences and the individual architectural style of the building. Additionally, you can also choose from a diverse range of door handles and furniture, available in many shapes and colours. Another option to customise your door's functionality is by adding fittings such as: strip locks, bolts, fingerprint readers or electromagnetic locks. All materials used to produce and equip our doors are sourced from reputable manufacturers with a proven track record.

- extra charge up to the width of „100“ (110 cm)
- extra charge for frame-plate doors up to the width of „82“ or plate doors „88“
- extra charge for higher doors (max 230)
- unusual width and height
- one-sided application
- extra charge for two-sided application
- extra charge for black colour INOX
- extra charge for aluminum threshold
- extra charge for threshold with aluminum strips
- extra charge for REFLEX glass
- extra charge for LAKOBEL glass
- extra charge for VENETIAN MIRROR
- extra charge for BLACK glass
- extra charge for MILK glass
- extra charge for ANTI-BURGLARY glass
- extra charge for colors from RAL palette
- extra charge for two-color painting
- extra charge for oiling
- extra charge for aging
- extra charge for strip-hook lock
- extra charge for strip-automatic lock

STANDARD	OPTIONAL	
72mm thick (panel-and-frame doors)	82mm thick (panel-and-frame doors)	p. 4
72mm thick (plate doors)	82mm thick (panel doors)	p. 5
2 independent 3-bolt locks	- strip hook lock - automatic strip lock	p. 66
adjustable lock striker		p. 4/5
anti-burglary hinge bolts		p. 4/5
double seal system		p. 4/5
antisol glass (door trim shown in the photos subject to an additional charge)	reflex glass, venetian mirror, opal glass, black glass, lakobel mirror glass, P4, Optional glass trim	cost depends on door model (please see icons)
steel reinforcement of the stile p.5		p. 5
4 hinges adjustable to 3 positions		p. 4/5
plastic decorative overlays for brackets available in the following colours: brass or INOX	aluminium decorative caps for hinges available in the following colours: brass or INOX	p. 69
wooden threshold	- thermal aluminium threshold (90mm) - threshold fitted with aluminium strips	p. 67
fixed frame (98mm wide)	adjustable frame	p. 67
5-coat painting (10 colours from the Homeefe Doors palette)	5-coat painting (colours from the RAL palette) 2 colour painting	information on pages 4/5 extra charge for RAL or the use of 2 colours (please see the icons)
XPS polystyrene insulation		p. 4/5
	bolts and specific accessories e.g., electromagnetic locks, push-button door opening	p. 64
	handles and cylinders	p. 64, 68, 69
	banding	p. 63
	extras	p. 62/63
	lighting	p. 62/63
	non-standard dimensions	cost for non-standard dimensions depends on door model (see door icons)
	fingerprint reader, keypad etc	p. 66
	self-closing door mechanisms	p. 69
	door hole/viewer	p. 69



ADLER

WOOD DOOR CARE PRODUCTS + HARDWARE OIL

INCLUDED IN THE PRICE OF THE DOOR

Hinges

4 hinges Ø 20 with a Teflon insert, adjustable to three positions

Varnishes

Our products are covered with 5 coats of high-quality primers and varnishes sourced from a reputable company. These are applied by spraying, which ensures an even surface coverage. **Please note that the colours shown in the catalogue are illustrative and actual product colours may vary.**

Plate

The door leaf is made of natural glued, laminated and veneered wood (5.5 mm & / a thickness of 72mm or 82mm) Thermally insulating sandwich core of thickness:

- in doors with a thickness of 72mm: 38 mm insulated with 30mm XPS polystyrene + 2x9mm waterproof plywood, veneered with oak.
- in doors with a thickness of 82mm: 48 mm insulated with 40mm XPS polystyrene + 2x9mm waterproof plywood, veneered with oak.

THERMAL PERFORMANCE AND PERMEABILITY OF DOORS

- 72 mm full Ud 1,2 W /m²K
- 72 mm glazed Ud 1,3 W /m²K
- 82 mm full Ud 1,0 W /m²K
- 82 mm glazed Ud 1,2 W /m²K



Double Glazed Glass

All panel-and-frame models - double glazed 3-pane unit (black antisol or lakobel mirror options)

Door Lock

2 independent 3-bolt locks with an adjustable latch provided as standard, additional options include a hook or automatic strip lock



Polystyrene XPS 30 / 40 MM



Strengthening Pins (5pcs)

2 x Gasket Q-LON

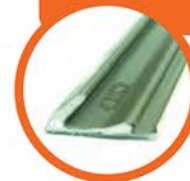

ANTI-BURGLARY BOLTS

DOOR CROSS SECTION 72 / 82 MM

OAK PLUS

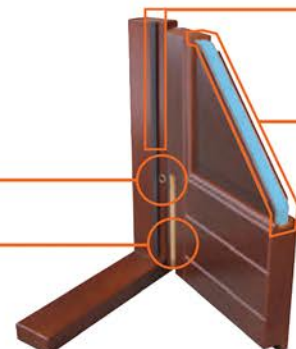
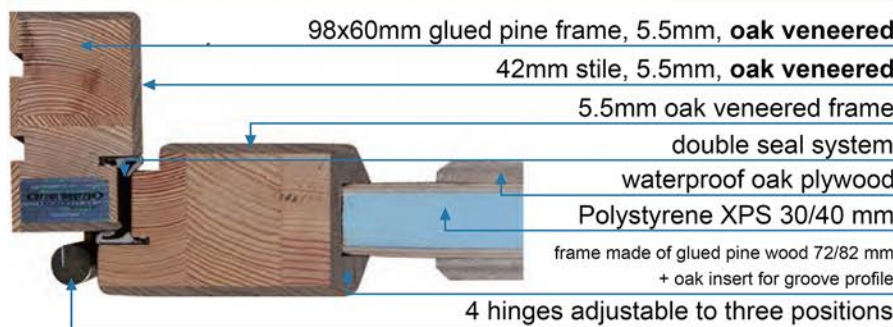

COLOURS pine + oak palette / oak palette



• PROTECTION AGAINST RAIN AND SUN CARE (WITH ADLER CARE PRODUCTS)

Varnishes

Our products are covered with 5 coats of high-quality primers and varnishes sourced from a reputable company. These agents are applied by spraying, which ensures an even surface coverage. **Please note that the colours shown in the catalogue are illustrative and actual product colours may vary.**

Door Lock

2 independent 3-bolt locks with an adjustable latch are provided as standard, additional options include a hook or automatic strip lock



Plate

The door leaf is made of natural glued, laminated and veneered wood with a thickness of 78mm or 88mm. The thermal insulation is made of XPS polystyrene 60 or 70 mm.

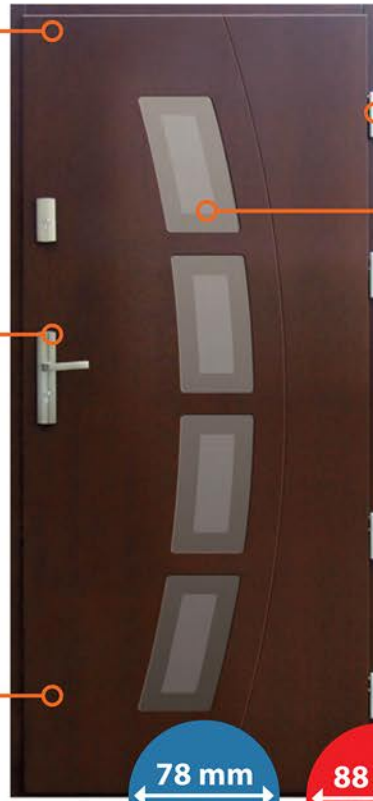

78 mm
STANDARD THICKNESS

88 mm
OPTIONAL THICKNESS
EXTRA WARM

Hinges

4 hinges Ø 20 with a Teflon insert, adjustable to three positions

Double Glazed Glass

A range of double-glazing options: reflex, Venetian mirror, frosted glass, P4, "3D" black glass and Lakobel mirror (please see icons next to the door.) We offer doors models fitted with glass printed with graphics, making the door unique with its own individual character. There is also the option to print designs or patterns provided by our customers.

Polystyrene XPS
60 / 70 MM



Strengthening Pins (5pcs)

2 x Gasket Q-LON

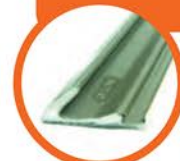

ANTI-BURGLARY BOLTS

THERMAL PERFORMANCE AND PERMEABILITY OF DOORS

- 78 mm full **Ud 0,86 W /m²K**
- 78 mm glazed **Ud 1,0 W /m²K**
- 88 mm full **Ud 0,79 W /m²K**
- 88 glazed **Ud 0,95 W /m²K**

DOOR CROSS SECTION 78 / 88 MM

OAK PLUS

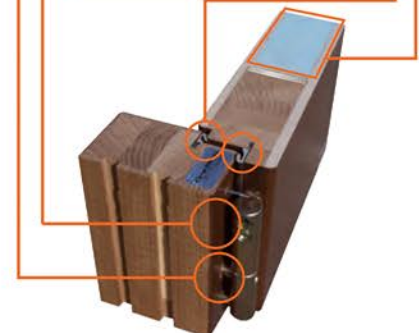
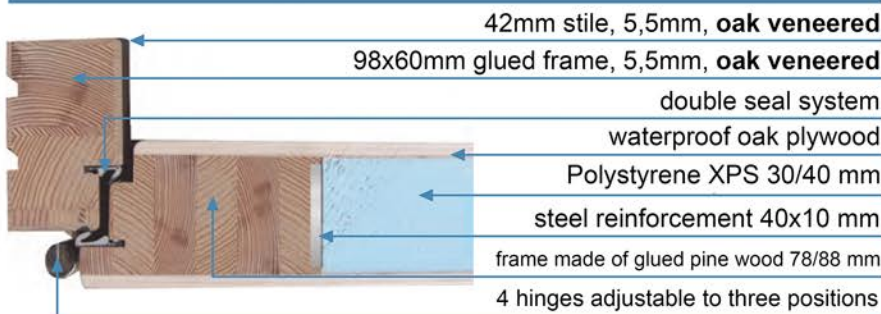

COLOURS pine + oak palette / oak palette



* PROTECTION AGAINST RAIN AND SUN CARE (WITH ADLER CARE PRODUCTS)

door width 80 / 90 / 100
glass size 116 x 1352



PRO 20

- +10%
- + £124
- +10%
-
- + £74
- + £38
- + £125
-
- + £139
- + £125
- + £110
- + £121
- + £120
- + £142
- + £210
- + £246

door width 80 / 90 / 100
glass size 60 x 1485



PRO 21

- +10%
- + £124
- +10%
-
- + £74
- + £38
- + £125
-
- + £139
- + £125
- + £110
- + £121
- + £120
- + £142
- + £210
- + £246

door width 80 / 90 / 100
glass size 130 x 230



PRO 23

- +10%
- + £124
- +10%
-
- + £74
- + £38
- + £125
-
- + £139
- + £125
- + £110
- + £121
- + £120
- + £142
- + £210
- + £246

door width 80 / 90 / 100
glass size 60 x 1260

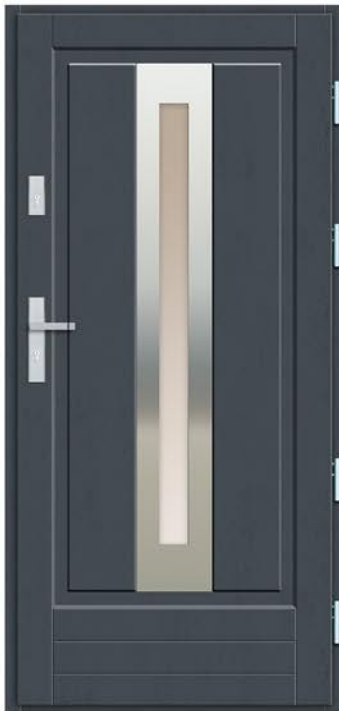

PRO 22

- +10%
- + £124
- +10%
-
- + £74
- + £38
- + £74
- + £125
-
- + £139
- + £125
- + £110
- + £121
- + £120
- + £142
- + £210
- + £246

door width 80 / 90 / 100
glass size 60 x 1260



PRO 17

- +10%
- + £124
- +10%
-
- + £74
- + £38
- + £74
- + £125
-
- + £139
- + £125
- + £110
- + £121
- + £120
- + £142
- + £210
- + £246

door width 80 / 90 / 100
glass size 60 x 1260



PRO 18

- +10%
- + £124
- +10%
-
- + £74
- + £38
- + £74
- + £125
-
- + £139
- + £125
- + £110
- + £121
- + £120
- + £142
- + £200
- + £246

We have prepared a special promotional range of doors for our customers. For this year only, you have the opportunity to purchase these Homeefe branded doors for very attractive prices. We have selected a wide variety of models to suit all tastes.

door width 80 / 90 / 100



PRO 07

-  +10%
-  +£160
-  +20%
-  +10%
- 
-  +£74
-  +£38
- 
- 
- 
- 
- 
- 
-  +£120
-  +£142
-  +£210
-  +£246

door width 80 / 90 / 100
glass size 227 x 1467



PRO 08

-  +10%
-  +£160
-  +20%
-  +10%
- 
-  +£74
-  +£38
-  +£125
- 
-  +£139
-  +£125
-  +£110
-  +£121
-  +£120
-  +£142
-  +£210
-  +£246

door width 80 / 90 / 100
glass size 406 x 68



PRO 14

-  +10%
-  +£160
-  +20%
-  +10%
- 
-  +£74
-  +£38
-  +£125
- 
-  +£139
-  +£125
-  +£110
-  +£121
-  +£120
-  +£142
-  +£210
-  +£246

door width 80 / 90 / 100
glass size 1510 x 61



PRO 10

-  +10%
-  +£160
-  +20%
-  +10%
- 
-  +£74
-  +£38
-  +£74
-  +£125
- 
-  +£139
-  +£125
-  +£110
-  +£121
-  +£120
-  +£142
-  +£210
-  +£246

door width 80 / 90 / 100
glass size 90 x 1170



PRO 11

-  +10%
-  +£160
-  +20%
-  +10%
- 
-  +£74
-  +£38
-  +£74
-  +£125
- 
-  +£139
-  +£125
-  +£110
-  +£121
-  +£120
-  +£142
-  +£210
-  +£246

door width 80 / 90 / 100
glass size 85 x 1610



PRO 12

-  +10%
-  +£160
-  +20%
-  +10%
- 
-  +£74
-  +£38
-  +£74
-  +£125
- 
-  +£139
-  +£125
-  +£110
-  +£121
-  +£120
-  +£142
-  +£210
-  +£246

Loft

Wooden doors with concrete structural elements. The industrial austerity of this collection perfectly suits building and interiors of a minimalist architectural style. An application of concrete on the external side of the door only as standard - concrete on both sides available for an extra charge.

d3 width 150 (50+100)
glass size 380 x 1980

door width 80 / 90 / 100

GLAZING: black anthrysol

Door colours: Door frame and extension frame – RAL 7016 (anthracite) Door Leaf – grey concrete + oiling, glazing bead on extension frame. Fittings – Pull handle LM 190cm and AXA hinge caps painted with RAL 9005

Loft
LT 01

- +10%
- + £160
- +20%
- +10%
-
- + £235
- + £74
- + £38
-
-
-
-
-
-
- + £120
- + £142
- + £106
- + £317
- + £210
- + £246

The Loft collection includes 4 standard concrete colours from the exterior and optionally from the interior of the door.

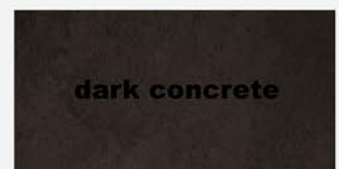
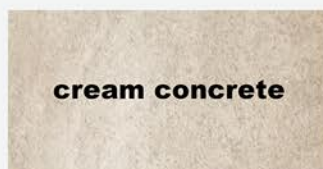
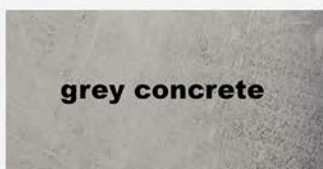

d3 width 150 (50+100)
glass size 380 x 1980

door width 80 / 90 / 100

Loft
LT 02

GLAZING: black anthrhyzol + trim

DOOR COLOURS: Oiled door frame and frame extender. Door leaf, grey concrete + oiling
FITTINGS: AXA Niagara West handle + top plate + AXA inox hinge caps

- +10%
- +£160
- +20%
- +10%
- +£235
- +£74
- +£38
- +£120
- +£142
- +£106
- +£314
- +£210
- +£246

door width 80 / 90 / 100
glass size 135 x 1770

Loft
LT 08

GLAZING: black anthrhyzol

DOOR COLOURS: Frame and frame extender RAL 9005. Door leaf, grey concrete
FITTINGS: WP pull handle + ceres solo plate + AXA hinge caps painted in RAL 9005

- +10%
- +£160
- +20%
- +10%
- +£235
- +£74
- +£38
- +£125
- +£139
- +£125
- +£110
- +£121
- +£120
- +£142
- +£210
- +£246

d3 width 150 (50+100)
glass size 380 x 1980

door width 80 / 90 / 100
glass size 180 x 1410

Loft
LT 03

Extension: Antisol black + trim.
GLAZING: Door leaf: Antisol black + trim

DOOR COLOURS: Frame and frame extender RAL 9005 (black)
Door leaf, anthracite concrete. Oiled glazing bead
FITTINGS: Pull handle LM 120cm and AXA hinge caps painted in RAL 9005

- +10%
- +£160
- +20%
- +10%
- +£235
- +£74
- +£38
- +£115
- +£139
- +£125
- +£110
- +£121
- +£120
- +£142
- +£210
- +£246

DOOR COLOURS: frame and frame extender RAL 7016 (anthracite)
Door leaf, cream concrete, glazing bead concrete cream
FITTINGS: Pull handle LM 190cm and AXA hinge caps painted in RAL 7016 (anthracite)

d3 width 150 (50+100)
glass size 380 x 1980

door width 80 / 90 / 100

Loft
LT 04

GLAZING: black anthrhyzol

DOOR COLOURS: Frame and frame extender RAL 9005 (black)
Door leaf, cream concrete, glazing bead concrete cream
FITTINGS: Pull handle LM 190cm and AXA hinge caps painted in RAL 9005

- +10%
- +£160
- +20%
- +10%
- +£235
- +£74
- +£38
- +£120
- +£142
- +£120
- +£110
- +£121
- +£120
- +£142
- +£210
- +£246

d3 width 150 (50 +100)
glass size 380 x 1980

door width 80 / 90 / 100

GLAZING: black antirysol

Loft

LT 07

- +10%
- +£160
- +20%
- +10%
- +£235
- +£74
- +£38
- +£120
- +£142
- +£210
- +£246

DOOR COLOURS: The door frame and the frame of the add-on unit, anthracite concrete. The door leaf is anthracite concrete, glazing bead in the frame extender RAL 6033
FITTINGS: Pull handle LM 190cm painted RAL 6033, AXA hinge caps painted RAL 9005

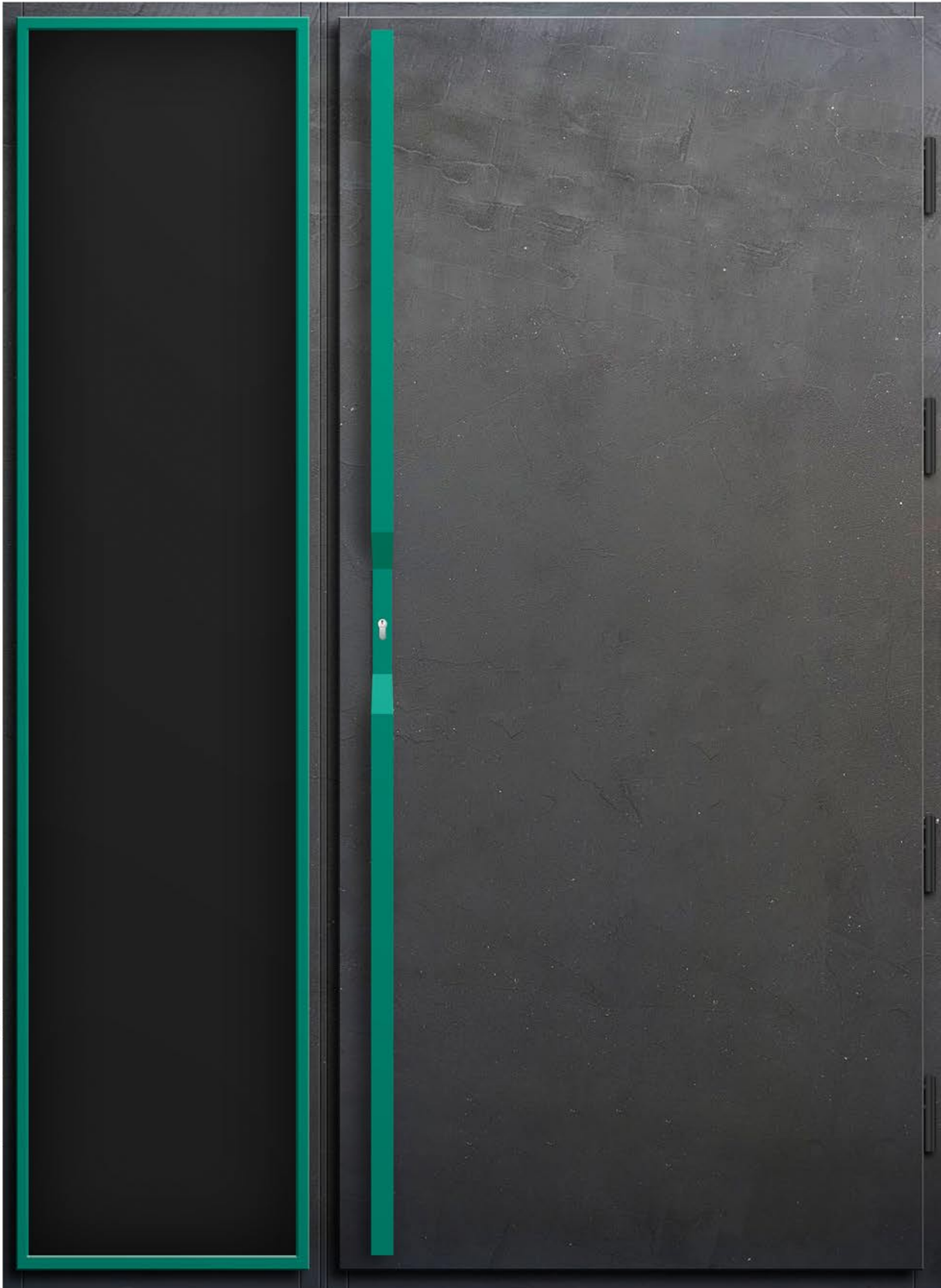

d3 width 150 (50+100)
glass size 380 x 1980

door width 80 / 90 / 100
glass size 135 x 1770



Loft

LT 09

- +10%
- + £160
- +20%
- +10%
- + £235
- + £74
- + £38
- + £125
- + £139
- + £125
- + £110
- + £121
- + £120
- + £142
- + £210
- + £246

door width 80 / 90 / 100
glass size 220 x 1720

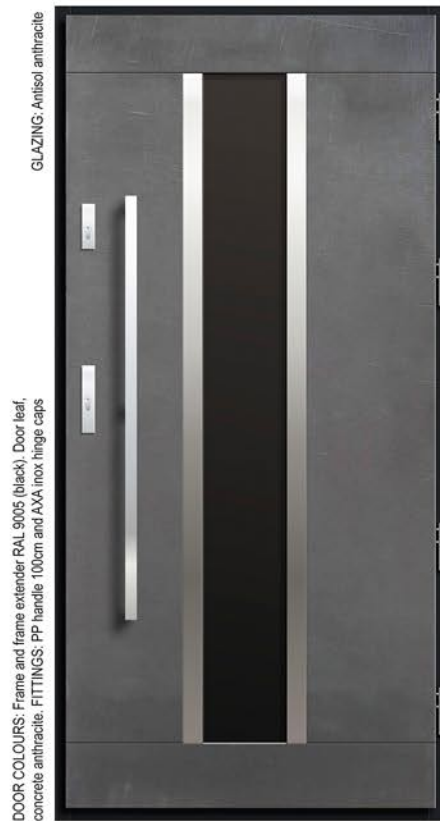

Loft

LT 22

- +10%
- + £160
- +20%
- +10%
- + £235
- + £74
- + £38
- + £74
- + £125
- + £139
- + £125
- + £110
- + £121
- + £120
- + £142
- + £210
- + £246

d4 width 150 (50+100)
glass size 120 x 120

door width 80 / 90 / 100

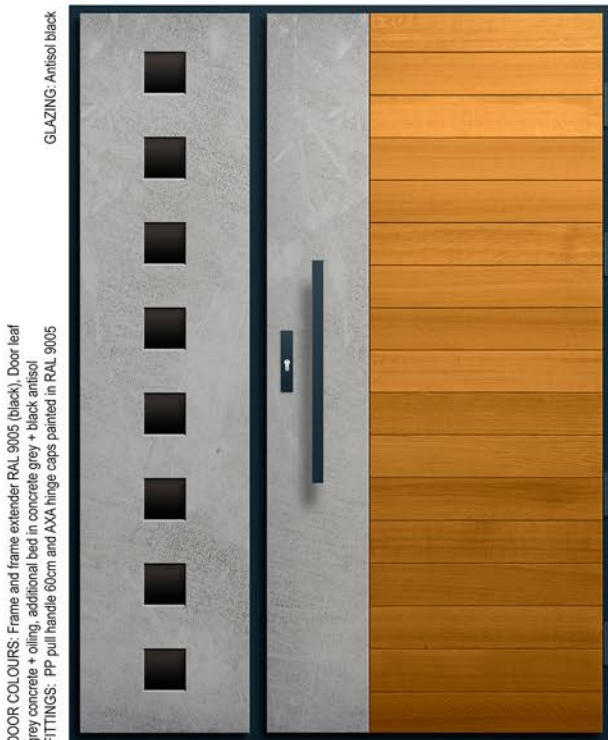

Loft

LT 15

- +10%
- + £160
- +20%
- +10%
- + £235
- + £74
- + £38
- + £120
- + £142
- + £106
- + £317
- + £210
- + £246

d4 width 150 (50+100)
glass size 70 x 1770

door width 80 / 90 / 100
glass size 70 x 1770



Loft

LT 11

- +10%
- + £160
- +20%
- +10%
- + £235
- + £74
- + £38
- + £74
- + £125
- + £135
- + £125
- + £110
- + £121
- + £120
- + £142
- + £210
- + £246

d3 width 150 (50+100)
glass size 380 x 1980

door width 80 / 90 / 100
glass size 125 x 1600

GLAZING: Wing: Antisol black, Extra bed: Antisol black + trim

DOOR COLOURS: Oiled door frame and frame extender. Door leaf grey concrete + oiling. FITTINGS: LM Pull handle 190cm and AXA hinge caps painted in RAL 9005

Loft

LT 21

- +10%
- +£160
- +20%
- +10%
-
- +£235
- +£74
- +£38
- +£125
-
- +£139
- +£125
- +£110
- +£121
- +£120
- +£142
- +£106
- +£371
- +£210
- +£246



d3 width 150 (50+100)
glass size 380 x 1980

door width 80 / 90 / 100

GLAZING: Anisot black

DOOR COLOURS: Oiled door frame and frame extender. Door leaf grey concrete + oiling
FITTINGS: WP Pull handle + ceres solo plate + AXA hinge caps painted in RAL 9005



Loft
LT 20

- +100+ +10%
- BB +£160
- b+ +20%
- V+ +10%
- D +£235
- ALU +£74
- L-ALU +£38
- RX +£125
- LL +£139
- LW +£125
- CZ +£110
- ML +£121
- PA +£121
- RAL +£120
- +£142
- +£106
- +£317
- H +£210
- A +£246

door width 80 / 90 / 100
glass size 100 x 1500

Loft
LT 25

- +100+ +10%
- BB +£160
- b+ +20%
- V+ +10%
- D +£235
- ALU +£74
- L-ALU +£38
- RX +£125
- LL +£139
- LW +£125
- CZ +£110
- ML +£121
- PA +£121
- RAL +£120
- +£142
- H +£210
- A +£246

FITTINGS: Pull handle PP-150 + AXA inox hinge caps



d3 width 150 (50+100)
glass size 380 x 1980

door width 80 / 90 / 100
glass size 130 x 1770

GLAZING: Door leaf Extension. Anisot black

DOOR COLOURS: Frame and frame extender RAL 9005 (black)
Concrete door leaf grey + oiling, glazing bead in the extension is oiled
FITTINGS: PP pull handle 177cm and AXA hinge caps painted RAL 9005



Loft
LT 17

- +100+ +10%
- BB +£160
- b+ +20%
- V+ +10%
- D +£235
- ALU +£74
- L-ALU +£38
- RX +£125
- LL +£139
- LW +£125
- CZ +£110
- ML +£121
- PA +£121
- RAL +£120
- +£142
- +£106
- +£314
- H +£210
- A +£246

d3 width 150 (50+100)
glass size 380 x 1980

door width 80 / 90 / 100
glass size 180 x 180

GLAZING: Door leaf. Anisot black
Extension: Anisot black + trim

DOOR COLOURS: The door frame and frame extender unit are oiled. Door leaf: dark concrete + oiling
FITTINGS: Pull handle LM-190cm and AXA hinge caps painted in RAL 9005



Loft
LT 18

- +100+ +10%
- BB +£160
- b+ +20%
- V+ +10%
- D +£235
- ALU +£74
- L-ALU +£38
- RX +£125
- LL +£139
- LW +£125
- CZ +£110
- ML +£121
- PA +£121
- RAL +£120
- +£142
- +£106
- +£314
- H +£210
- A +£246

d3 width 150 (50+100)
glass size 380 x 1980

door width 80 / 90 / 100
glass size 200 x 290

Loft

LT 19

- +10%
- +£160
- +20%
- +10%
- +£235
- +£74
- +£38
- +£125
- +£139
- +£125
- +£110
- +£121
- +£120
- +£142
- +£210
- +£246

GLAZING: Door leaf: Antisol black Extension: Antisol black + trim

DOOR COLOURS: Frame and frame extender RAL 9005 (black) Door leaf, concrete, anthracite, glazing bead in the add-on, concrete, anthracite
FITTINGS: PP handle 170cm and AXA hinge caps painted in RAL 9005



d3 width 150 (50+100)
glass 380 x 1980

door dimensions *80" / *90" / *100"

GLAZING: Antisol black + trim

DOOR COLOURS: The door frame and frame extender, door concrete, door leaf, dark concrete, bath glazing unit in the supplementary sheet dark concrete
FITTINGS: PP handle 180cm and AXA inox hinge caps



Loft

LT 10

- >100+ +10%
- BB +£143
- b+ +20%
- V +10%
- D +£236
- ALU +£71
- L-ALU +£35
- RK +£115
- LL +£129
- LW +£100
- CZ +£100
- ML +£100
- P4 +£104
- RAL +£107
- +£125
- +£107
- +£175
- H +£200
- A +£236

door dimensions *80" / *90" / *100"
glass size 110 x 1450

Loft

LT 27

- >100+ +10%
- BB +£143
- b+ +20%
- V +10%
- D +£236
- ALU +£71
- L-ALU +£35
- RK +£115
- LL +£129
- LW +£100
- CZ +£100
- ML +£100
- P4 +£104
- RAL +£107
- +£125
- +£107
- +£175
- H +£200
- A +£236

DOOR COLOURS: Frame: Anthracite concrete
Door leaf: Concrete anthracite +oiling. FITTINGS: Pull handle PP 190 + AXA inox hinge



d3 width 150 (50+100)
glass 380 x 1980

door dimensions *80" / *90" / *100"
glass size 200 x 1560

GLAZING: Door leaf: Antisol black
Extension: Antisol black + trim

DOOR COLOURS: The door frame and frame extender units are oiled. Door leaf concrete anthracite + oiling. FITTINGS: Pull handle LM 120 + AXA hinge caps painted in RAL 9005



Loft

LT 28

- >100+ +10%
- BB +£143
- b+ +20%
- V +10%
- D +£236
- ALU +£71
- L-ALU +£35
- RK +£15
- LL +£129
- LW +£100
- CZ +£100
- ML +£100
- P4 +£104
- RAL +£107
- +£125
- +£107
- +£175
- H +£200
- A +£236

d3 width 135 (35+100)
glass 230 x 1980

door dimensions *80" / *90" / *100"
glass size 60 x 2033
sight light 20 x 1170

GLAZING: Door leaf: Antisol black, Extension: Antisol black + trim
DOOR COLOURS: Frame and frame extender RAL 9005 (black)
Door leaf grey concrete + oiling, glazing bead in the add-on, oiled
FITTINGS: Pull handle LM 110cm and AXA hinge caps painted RAL 9005



Loft

LT 16

- >100+ +10%
- BB +£143
- b+ +20%
- V +10%
- D +£236
- ALU +£71
- L-ALU +£35
- RK +£115
- LL +£129
- LW +£100
- CZ +£100
- ML +£100
- P4 +£104
- RAL +£107
- +£125
- +£107
- +£175
- H +£200
- A +£236

FIORD

Restrained, minimalist, Scandinavian style with large glass surfaces designed to perfectly suit modern architecture. The true beauty of natural wood with its distinctive grain patterns, full of Scandinavian charm.

d3 width 150 (50+100)
glass size 380 x 1980

door width 80 / 90 / 100

GLAZING: Antisol black

FIORD

FD 08

+10%

+ £160

+20%

+10%

+ £74

+ £38

+ £120

+ £142

+ £106

+ £317

+ £210

+ £246

DOOR COLOURS: Frame and frame extender RAL 7016 (anthracite) Winchester door leaf, glazing bead in the extension
FITTINGS: PP handle, 140cm and AXA hinge caps painted in RAL 7016

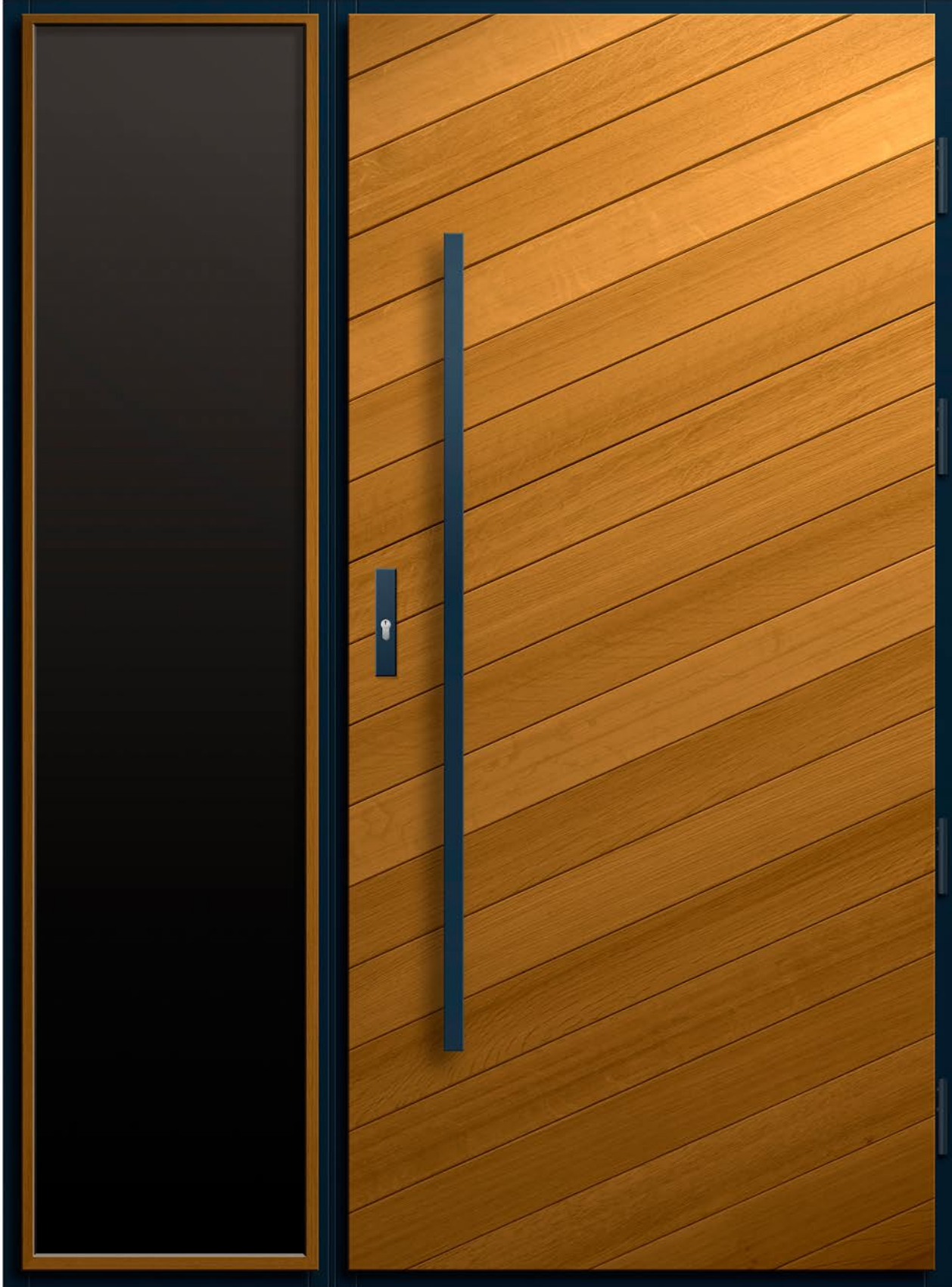

d3 width 175 (75+100)
glass size 630 x 1980

door width 80 / 90 / 100

GLAZING: Antisol black

DOOR COLOURS: Frame and frame extender RAL 7016 (anthracite) Winchester door leaf
FITTINGS: PP handle 140cm and AXA hinge caps painted RAL 9005



FIORD
FD 09

- +10%
- +£160
- +20%
- +10%
-
-
- +£74
- +£38
-
-
-
-
-
-
-
- +£120
- +£142
- +£120
- +£317
- +£210
- +£246

door width 80 / 90 / 100
glass size 100 x 1560

GLAZING: Antisol black

FITTINGS: PP handle 60cm and AXA inox hinge caps



FIORD
FD 10

- +10%
- +£130
- +20%
- +10%
-
-
- +£103
- +£74
- +£38
- +£74
- +£125
-
- +£139
- +£125
- +£110
- +£121
- +£120
- +£142
- +£106
- +£317
- +£210
- +£246

d3 width 150 (50+100)

door width 80 / 90 / 100
glass size 200 x 1560

GLAZING: Antisol black + trim

DOOR COLOURS: Oiled door leaf, extension oiled
FITTINGS: PP handle 100cm and AXA inox hinge caps



FIORD
FD 39

- +10%
- +£160
- +20%
- +10%
-
-
- +£74
- +£38
-
-
-
-
-
-
-
- +£120
- +£142
- +£120
- +£317
- +£210
- +£246

d3 width 150 (50+100)

door width 80 / 90 / 100
glass size 200 x 1560

GLAZING: Antisol black + trim

DOOR COLOURS: Frame and frame extender RAL 9005. Oiled door leaf and glazing bead. FITTINGS: PP handle 10cm and AXA hinge caps painted RAL 9005



FIORD
FD 39 S

- +10%
- +£160
- +20%
- +10%
-
-
- +£74
- +£38
-
-
-
-
-
-
-
- +£120
- +£142
- +£120
- +£317
- +£210
- +£246

13 width 160 (60+100)
glass size 480 x 2380

01 height 250 (210+40)

door width 80 / 90 / 100

GLAZING: Antisol black

FITTINGS: Pull handle KS 120CM and AXA hinge caps painted in RAL 9005

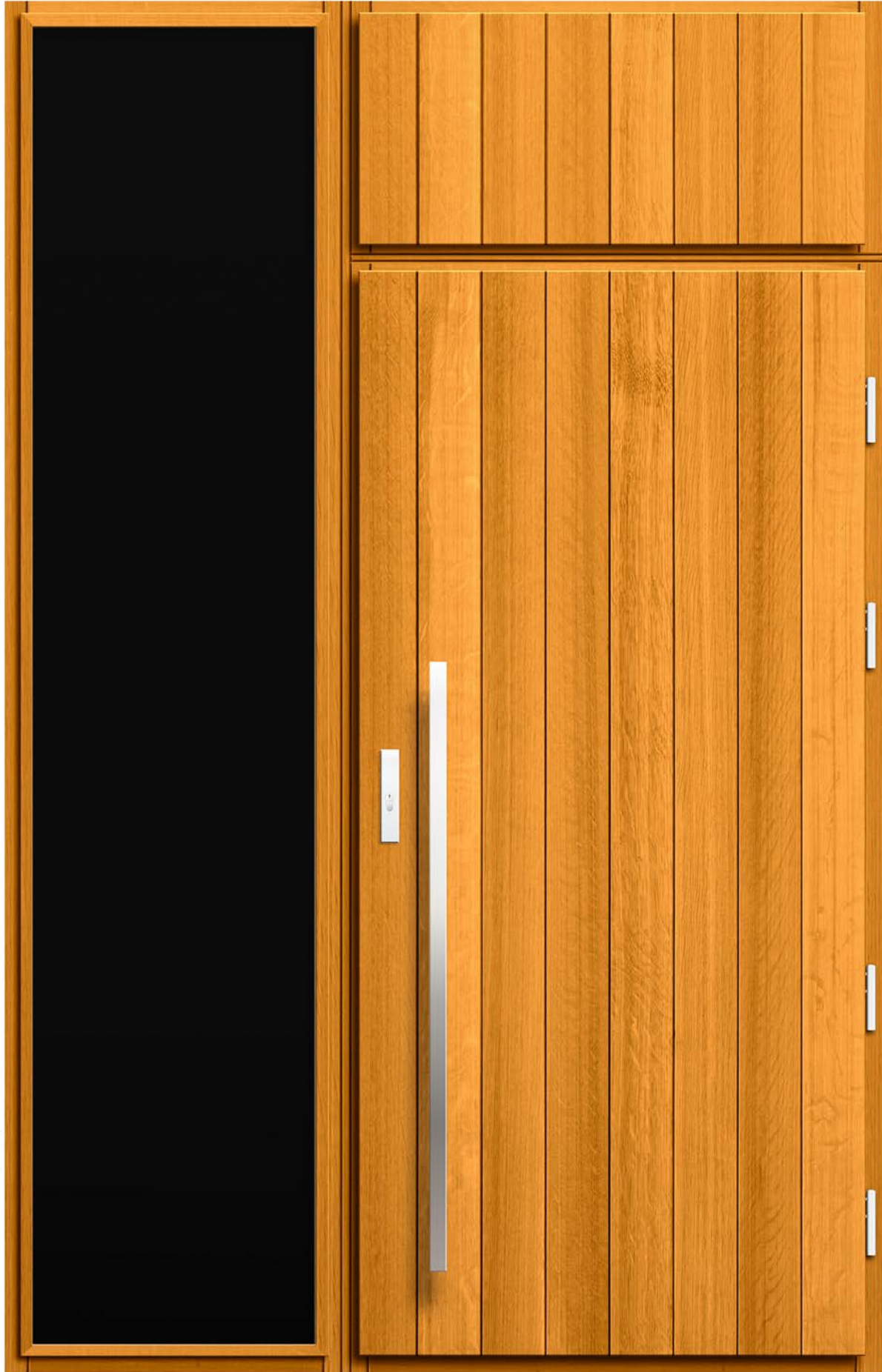

FIORD

FD 13

- +10%
- + £160
- +20%
- +10%
-
-
-
- + £74
- + £38
-
-
-
-
-
-
-
- + £120
- + £142
- + £106
- + £317
- + £210
- + £246

door width 80 / 90 / 100
glass size 200 x 1700

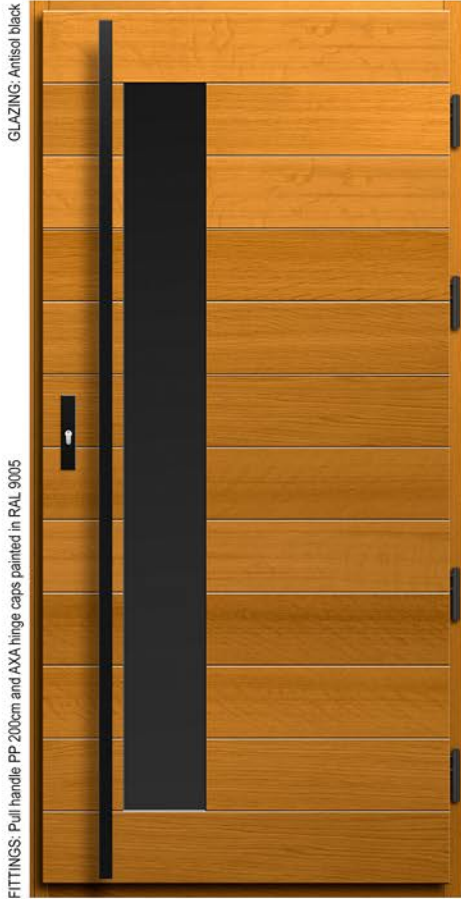

GLAZING: Antisol black

FITTINGS: Pull handle PP 200cm and AXA hinge caps painted in RAL 9005

FIORD

FD 46

- +10%
- + £160
- +20%
- +10%
-
- + £74
- + £38
- + £125
-
- + £139
- + £125
- + £110
- + £121
- + £120
- + £142
- + £106
- + £317
- + £210
- + £246

n1 height 270 (210+60)

door width 80 / 90 / 100
glass size 130 x 1740



FIORD

FD 16

- +10%
- + £160
- +20%
- +10%
-
- + £103
- + £106
- + £38
- + £74
- + £125
-
- + £139
- + £125
- + £110
- + £121
- + £120
- + £142
- + £106
- + £317
- + £210
- + £246

door width 80 / 90 / 100
glass size 120 x 1320



FORKING: PP Pull handle 132cm and AXA inox hinge caps

FIORD

FD 15

- +10%
- + £160
- +20%
- +10%
-
- + £74
- + £38
- + £125
-
- + £139
- + £125
- + £110
- + £121
- + £120
- + £142
- + £106
- + £317
- + £210
- + £246

door width 80 / 90 / 100
glass size 100 x 1600

width 150 (50+100) **d4**

GLAZING: Antisol black

FIORD

FD 17

- +10%
- +£160
- +20%
- +10%
-
-
- ALU +£74
- L-ALU +£38
- RX +£125
- LL
- LW +£139
- CZ +£125
- ML +£110
- P4 +£121
- RAL +£120
- +£142
- +£106
- +£317
- RH +£210
- RA +£246

FITTINGS: Pull handle KW 60cm and AXA inox hinge caps

width 128 (28+100)
glass size 160 x 1980

door width 80 / 90 / 100
glass size 120 x 1440

GLAZING: Door leaf and extension: Antisol black

FIORD

FD 18

- +10%
- +£160
- +20%
- +10%
-
-
- ALU +£74
- L-ALU +£38
- RX +£125
- LL
- LW +£139
- CZ +£125
- ML +£110
- P4 +£121
- RAL +£120
- +£142
- +£106
- +£317
- RH +£210
- RA +£246

FITTINGS: Door leaf and extension: Antisol black

d3 width 175 (75+100)
glass size 630 x 1980

door width 80 / 90 / 100
glass size 230 x 2033 / sight line 80 x 1800

GLAZING: Antisol black + trim

FIORD

FD 40

- +10%
- +£160
- +20%
- +10%
-
-
- ALU +£74
- L-ALU +£38
- RX
- LL
- LW
- CZ
- ML
- P4
- RAL +£120
- +£142
- +£106
- +£317
- RH +£210
- RA +£246

DOOR COLOURS: Frame and frame extender RAL 7016 (anthracite), Winchester door leaf
FITTINGS: PP handle 190cm and AXA inox hinge caps

d3 width 160 (60+100)
glass size 480 x 1980

door width 80 / 90 / 100

GLAZING: Antisol black

FIORD

FD 20

- +10%
- +£160
- +20%
- +10%
-
-
- ALU +£74
- L-ALU +£38
- RX
- LL
- LW
- CZ
- ML
- P4
- RAL +£120
- +£142
- +£106
- +£317
- RH +£210
- RA +£246

FITTINGS: PP handle 190cm and AXA inox hinge caps

d4 width 150 (50+100)
glass 430 x 60 / sight line 190 x 25

door width 80 / 90 / 100
glass size 925 x 60 / sight line 620 x 25

GLAZING: Lakobel + Antisol black

FITTINGS: PP handle 190cm and AXA inox hinge caps

FIORD
FD 21

- P100+** +10%
- BB** +£160
- H+** +20%
- V** +10%
- I**
- II**
- ALU** +£74
- L-ALU** +£38
- RX** +£125
- LL** +£228
- LW** +£139
- CZ** +£125
- ML** +£110
- PA** +£121
- RAL** +£120
- +£142
- +£106
- +£317
- H** +£210
- A** +£246

door width 80 / 90 / 100
glass size 80 x 640

FIORD
FD 36

- P100+** +10%
- BB** +£160
- H+** +20%
- V** +10%
- I**
- II**
- ALU** +£74
- L-ALU** +£38
- RX** +£125
- LL**
- LW** +£139
- CZ** +£125
- ML** +£110
- PA** +£121
- RAL** +£120
- +£142
- +£106
- +£317
- H** +£210
- A** +£246

door width 80 / 90 / 100
glass size 310 x 1600

GLAZING: Antisol black + firm

FITTINGS: KW handle 80cm and AXA inox hinge caps

FIORD
FD 23

- P100+** +10%
- BB** +£160
- H+** +20%
- V** +10%
- I**
- II**
- ALU** +£74
- L-ALU** +£38
- RX** +£125
- LL**
- LW** +£139
- CZ** +£125
- ML** +£110
- PA** +£121
- RAL** +£120
- +£142
- +£106
- +£317
- H** +£210
- A** +£246

d3 width 200 (50+100+50)
glass size 380 x 1980

door width 80 / 90 / 100

GLAZING: Antisol black

FITTINGS: KP handle 100cm and AXA inox hinge caps

FIORD
FD 43

- P100+** +10%
- BB** +£160
- H+** +20%
- V** +10%
- I**
- II**
- ALU** +£74
- L-ALU** +£38
- RX**
- LL**
- LW**
- CZ**
- ML**
- PA**
- RAL** +£120
- +£142
- +£106
- +£317
- H** +£210
- A** +£246

d3 width 150 (50+100)
glass size 480 x 1980

door width 80 / 90 / 100
glass size 120 x 1560

GLAZING: Door leaf: Antisol black. Extension: Antisol black + trim

FIORD
FD 33

- +100+ +10%
- BB + £160
- h+ +20%
- V +10%
- I
- II
- ALU + £74
- L-ALU + £38
- RK + £125
- LL
- LW + £139
- CZ + £125
- ML + £110
- P4 + £121
- RAL + £120
- + £142
- + £106
- + £317
- H + £210
- A + £246

d4 width 150 (50+100)

door width 80 / 90 / 100
glass size 200 x 1560

GLAZING: Antisol black

FIORD
FD 11

- +100+ +10%
- BB + £160
- h+ +20%
- V +10%
- I
- II
- ALU + £74
- L-ALU + £38
- RK + £125
- LL
- LW + £139
- CZ + £125
- ML + £110
- P4 + £121
- RAL + £120
- + £142
- + £106
- + £317
- H + £210
- A + £246

DOOR COLOURS: Frame and frame extender RAL 9005 (black) Winchester door leaf, Winchester extension. FITTINGS: PP pull handle 60cm and AXA hinge caps painted RAL 9005

d4 width 130 (100+30)

door width 80 / 90 / 100
glass 2033 x 585 / sight line 195 x 1600

GLAZING: Lakobel + antisol black graphite

FIORD
FD 01

- +100+ +10%
- BB + £160
- h+ +20%
- V +10%
- I
- II
- ALU + £74
- L-ALU + £38
- RK + £125
- LL + £228
- LW + £139
- CZ + £125
- ML + £110
- P4 + £121
- RAL + £120
- + £142
- + £106
- + £317
- H + £210
- A + £246

FITTINGS: PP pull handle 10cm and AXA inox hinge caps

d11 width 200 (50+100+50)
glass 400 x 1998 / sight line 280 x 1878

door width 80 / 90 / 100

GLAZING: Lakobel + Antisol black

FIORD
FD 02

- +100+ +10%
- BB + £160
- h+ +20%
- V +10%
- I
- II
- ALU + £74
- L-ALU + £38
- RAL + £120
- + £142
- + £106
- + £317
- H + £210
- A + £246

FITTINGS: PP pull handle 15cm and AXA hinge caps inox

d3 width 145 (45+100)
glass 350 x 1998 / sight line 230 x 1878

door width 80 / 90 / 100
glass size 100 x 1500

GLAZING: Antisol black + trim

FIORD
FD 37 S

- +10%
- + £160
- +20%
- +10%
-
-
- + £74
- + £38
-
-
-
-
-
-
- + £120
- + £142
- + £106
- + £317
- + £210
- + £246

d4 width 150 (50+100)
glass 350 x 1998 / sight line 230 x 1878

door width 80 / 90 / 100
glass size 100 x 1500

GLAZING: Door leaf: Antisol black Extension: Lakobel + Antisol graphite

FIORD
FD 04

- +10%
- + £160
- +20%
- +10%
-
-
- + £74
- + £38
- + £125
-
- + £139
- + £125
- + £110
- + £121
- + £125
- + £142
- + £106
- + £317
- + £210
- + £246

FITTINGS: Pull handle KW 155cm and AXA inox hinge caps

d11 width 145 (45+100)
glass 350 x 1998 / sight line 230 x 1878

door width 80 / 90 / 100

GLAZING: Lakobel + Antisol black

FIORD
FD 07

- +10%
- + £160
- +20%
- +10%
-
-
- + £74
- + £38
- + £74
- + £120
- + £142
- + £106
- + £317
- + £210
- + £246

d3 width 150 (50+100)
glass size 380 x 1980

door width 80 / 90 / 100
glass size 685 x 50

GLAZING: Door leaf and Extension: Antisol black

FIORD
FD 28

- +10%
- + £160
- +20%
- +10%
-
-
- + £74
- + £38
- + £125
-
- + £139
- + £125
- + £110
- + £121
- + £120
- + £142
- + £106
- + £317
- + £210
- + £246

d3 width 160 (60+100)
glass size 480 x 1980

door width 80 / 90 / 100

GLAZING: Antisol black

FIORD

FD 41

-  +10%
-  + £160
-  +20%
-  +10%
-  + £74
-  + £38
-  + £120
-  + £142
-  + £107
-  + £317
-  + £210
-  + £246

FITTINGS: Pull handle KW 70cm and AXA hinge caps painted RAL 9005



d3 width 150 (50+100)
glass size 380 x 1980

door width 80 / 90 / 100

GLAZING: Antisoi black + trim

FIORD
FD 25

- 100+** +10%
- BB** + £160
- H+** +20%
- V** +10%
- I**
- II**
- ALU** + £74
- L-ALU** + £38
- RK**
- LL**
- LW**
- CZ**
- ML**
- P4**
- RL** + £120
- + £142
- + £106
- + £317
- H** + £210
- A** + £246

d4 width 160 (60+100)

door width 80 / 90 / 100
glass size 180 x 1560

GLAZING: Antisoi black + trim

FIORD
FD 26

- 100+** +10%
- BB** + £160
- H+** +20%
- V** +10%
- I**
- II**
- ALU** + £74
- L-ALU** + £38
- CZ** + £74
- RK** + £125
- LW** + £139
- CZ** + £125
- ML** + £110
- P4** + £121
- RL** + £120
- + £142
- + £106
- + £317
- H** + £210
- A** + £246

FITTINGS: PP handle 160cm and AXA inox hinge caps

d3 width 150 (50+100)
glass size 380 x 1980

door width 80 / 90 / 100
glass size 120 x 1320

GLAZING: Leaf and extender: Venetian mirror

FIORD
FD 34

- 100+** +10%
- BB** + £160
- H+** +20%
- V** +10%
- I**
- II**
- ALU** + £74
- L-ALU** + £38
- RK** + £125
- LL**
- LW** + £139
- CZ** + £125
- ML** + £110
- P4** + £121
- RL** + £120
- + £142
- + £106
- + £317
- H** + £210
- A** + £246

FITTINGS: PP handle 132cm and AXA inox hinge caps

d3 width 150 (60+100)
glass size 480 x 1980

door width 80 / 90 / 100
glass size 685 x 50

GLAZING: Antisoi black + trim

FIORD
FD 27

- 100+** +10%
- BB** + £160
- H+** +20%
- V** +10%
- I**
- II**
- ALU** + £74
- L-ALU** + £38
- RK**
- LL**
- LW**
- CZ**
- ML**
- P4**
- RL** + £120
- + £142
- + £106
- + £317
- H** + £210
- A** + £246

FITTINGS: Pull handle GP 160cm and AXA inox hinge caps

d3 width 150 (50+100)
glass size 480 x 1980

door width 80 / 90 / 100
glass size 120 x 1560

Glass in extension: Antisol black

DOOR COLOURS: The door frame and the frame of the add-on unit RAL 9005. The door leaf is and bead in the frame extender oiling. FITTINGS: PP pull handle 60cm and AXA hinge caps painted in RAL 9005

FIORD

FD 44 S

-  +10%
-  + £160
-  +20%
-  +10%
-  1
-  2
-  + £74
-  + £38
-  100
-  11
-  12
-  13
-  14
-  15
-  16
-  17
-  18
-  19
-  20
-  21
-  22

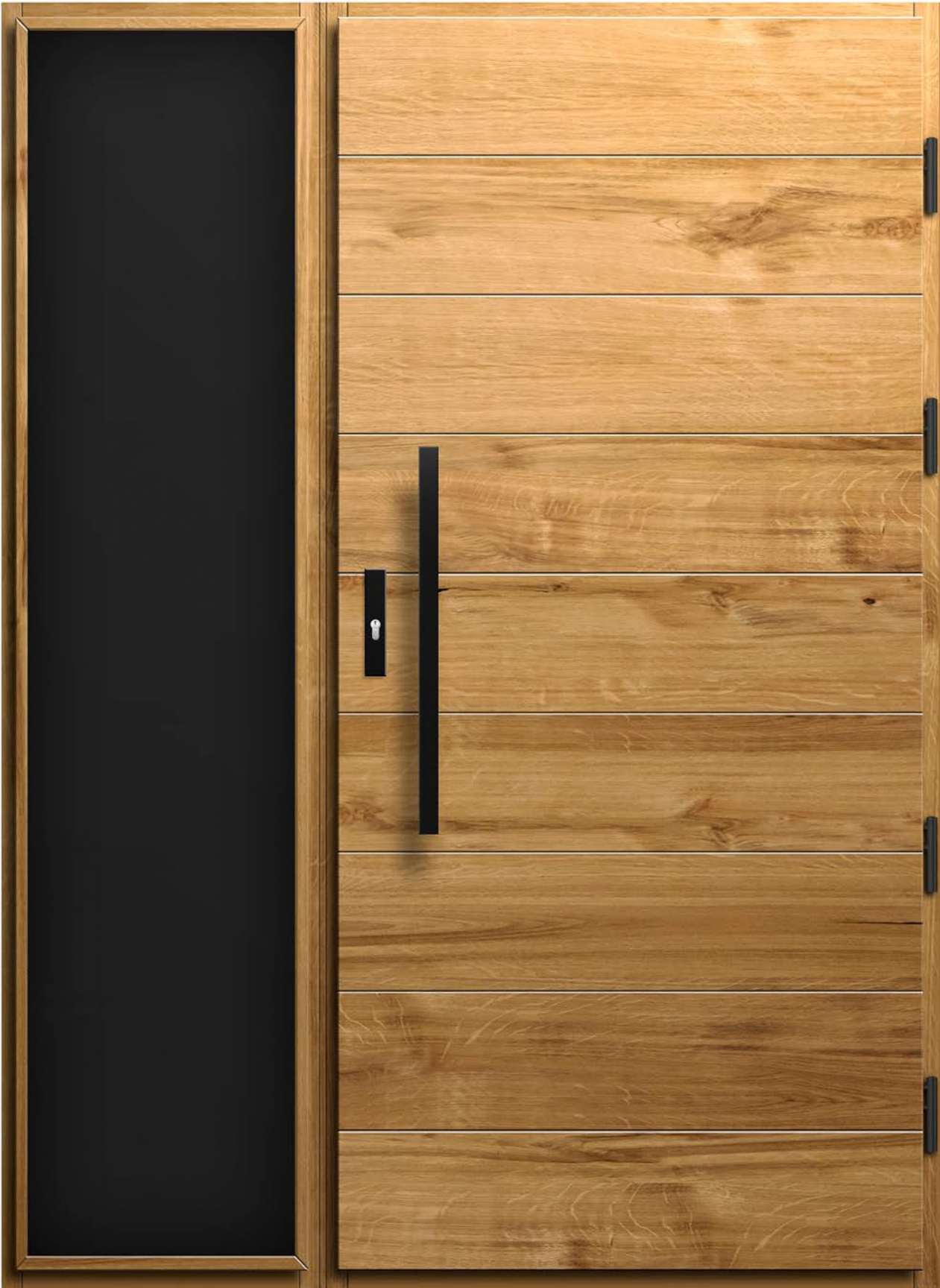

d3 width 150 (50+100)
glass size 480 x 1980

door width 80 / 90 / 100
glass size 120 x 1560

glass in extension: antisol black + trim

FIORD
FD 44

- >100+ +10%
- BB +£160
- h+ +20%
- V +10%
- I
- II
- ALU +£74
- L-ALU +£38
- RX +£125
- LL +£228
- LW +£139
- CZ +£125
- ML +£110
- P4 +£121
- RAL +£120
- +£142
- +£106
- +£317
- H +£210
- A +£246

d4 width 150 (50+100)

door width 80 / 90 / 100
glass size 300 x 2033, sight line 180 x 1440

GLAZING: Lacobel + antisol graphite

FIORD
FD 30

- >100+ +10%
- BB +£160
- h+ +20%
- V +10%
- I +£103
- II +£74
- ALU +£38
- L-ALU +£74
- RX +£125
- LL +£228
- LW +£139
- CZ +£125
- ML +£110
- P4 +£121
- RAL +£120
- +£142
- +£106
- +£317
- H +£210
- A +£246

FITTINGS: PP handle 200cm +, Moving knob and AXA hinge caps painted in RAL 9005, inserts made of inox steel

d4 width 150 (50+100)
glass size 230 x 2033, sight line 80 x 1800

GLAZING: Leaf and extension: Lakobel + black antisol

FIORD
FD 35

- >100+ +10%
- BB +£160
- h+ +20%
- V +10%
- I
- II
- ALU +£74
- L-ALU +£38
- RX +£125
- LL +£228
- LW +£139
- CZ +£125
- ML +£110
- P4 +£121
- RAL +£120
- +£142
- +£106
- +£317
- H +£210
- A +£246

FITTINGS: PP handle 80cm and AXA inox hinge caps

d3 width 150 (50+100)
glass size 380 x 1980

door width 80 / 90 / 100
glass size 725 x 120, sight line 480 x 60

GLAZING: Leaf: Lakobel + black antisol
Extra bet: Antisol black + trim

FIORD
FD 32

- >100+ +10%
- BB +£160
- h+ +20%
- V +10%
- I
- II
- ALU +£74
- L-ALU +£38
- RX +£125
- LL +£228
- LW +£139
- CZ +£125
- ML +£110
- P4 +£121
- RAL +£120
- +£142
- +£106
- +£317
- H +£210
- A +£246

FITTINGS: PP Pull handle 80cm and AXA inox hinge caps

GLASS

Following in the footsteps of modern architecture, glass has been used as an essential addition to external doors. In the glass collection we have designed models intended for avant-garde projects.



GLAZING: Leaf and extender: Lakobel + antisol black

FITTINGS: AXA Niagara West handle + moving knob and AXA hinge caps painted in RAL 9005

G4 width 150 (50+100)
glass size 250 x 2033 / sight line 210 X 1710

door width 80 / 90 / 100
glass size 250 x 2033 / sight line 210 x 1710

GLASS

G 61

- +10%
- + £160
- +20%
- +10%
-
- + £74
- + £38
- + £125
- + £228
- + £139
- + £125
- + £110
- + £121
- + £120
- + £142
- + £210
- + £246

door width 80 / 90 / 100
glass size 230 x 2033 / sight line 80 x 1700



GLASS

G 48

- +10%
- +£160
- +20%
- +10%
-
-
- +£74
- +£38
- +£125
- +£228
- +£139
- +£125
- +£110
- +£121
- +£120
- +£142
- +£210
- +£246

FITTINGS: PP Pull handle 140cm and AXA INOX hinge caps

GLAZING: Lakobel + aniscol graphite

d4 width 180 (80+100)
glass size 730 x 2033 / sight line 490 x 1593



GLASS

G 47

- +10%
- +£160
- +20%
- +10%
-
-
- +£74
- +£38
-
-
-
-
-
- +£120
- +£142
- +£210
- +£246

FITTINGS: PP handle 140cm and AXA hinge caps painted in RAL 9005

GLAZING: Leaf, Lakobel, Extra bed, Lakobel + aniscol graphite

d4 width 150 (50+100)
glass 2033 x 425 / sight line 300 x 1480



GLASS

G 49

- +10%
- +£160
- +20%
- +10%
-
-
- +£74
- +£38
- +£125
- +£228
- +£139
- +£125
- +£110
- +£121
- +£120
- +£142
- +£210
- +£246

FITTINGS: PP Pull handle 150cm and AXA inox hinge caps

GLAZING: Leaf and Extra bed, Lakobel + aniscol black

door width 80 / 90 / 100
glass 2033 x 585 / sight line 195 x 1600



GLASS

G 38

- +10%
- +£160
- +20%
- +10%
-
-
- +£74
- +£38
- +£125
- +£228
- +£139
- +£125
- +£110
- +£121
- +£120
- +£142
- +£210
- +£246

FITTINGS: PP handle 200cm and AXA inox hinge caps

GLAZING: Sash and delivery, Lakobel mirror

d3 width 150 (60+100)
glass 380 x 1980

door width 80 / 90 / 100
glass size 260 x 2033 / sight line 95 x 1455

GLAZING: Wing: Lakobel + black anisot. Extra bed: Black anisot

GLASS

G 50

- +10%
- +£160
- +20%
- +10%
-
- +£74
- +£38
- +£125
- +£228
- +£139
- +£125
- +£110
- +£121
- +£120
- +£142
- +£210
- +£246

FITTINGS: PP handle 150cm and AXA inox hinge caps



GLAZING: Lakobel + antisol graphite



door width 80 / 90 / 100
glass size 300 x 2033 / sight line 100 x 1340

GLASS

G 52

- +10%
- +£160
- +20%
- +10%
-
- +£74
- +£38
- +£125
- +£228
- +£139
- +£125
- +£110
- +£121
- +£120
- +£142
- +£210
- +£246

GLAZING: Lakobel + antisol graphite



door width 80 / 90 / 100
glass size 400 x 1800 / sight line 120 x 1340

GLASS

G 64

- +10%
- +£160
- +20%
- +10%
-
- +£74
- +£38
- +£120
- +£228
- +£139
- +£125
- +£110
- +£121
- +£120
- +£142
- +£210
- +£246

GLAZING: Lakobel + antisol black



door width 80 / 90 / 100
glass size 160 x 2033 / sight line 120 x 350 x 3 pcs.

GLASS

G 63

- +10%
- +£160
- +20%
- +10%
-
- +£74
- +£38
- +£125
- +£228
- +£139
- +£125
- +£110
- +£121
- +£120
- +£142
- +£210
- +£246

FITTINGS: PP handle 160cm and AXA hinge caps painted in RAL 9005

d4 width 160 (60+100)
glass 450 x 150 / sight line 240 x 60

door width 80 / 90 / 100
glass size 925 x 150 / sight line 590 x 60

GLAZING: Leaf and extender: Lakobel + antiscid graphite

GLASS
G 37

- +10%
- +£160
- +20%
- +10%
- +£74
- +£38
- +£125
- +£228
- +£139
- +£125
- +£110
- +£121
- +£120
- +£142
- +£210
- +£246



What is a Lakobel Mirror?

It is glass painted in black which gives a mirror-like effect during the day. At night, with reduced external lighting, the glass becomes transparent as light shining from inside makes the interior of the house visible.



14 width 150 (50+100)
glass 430 x 2033 / sight line 210 x 1710

door width 80 / 90 / 100
glass size 250 x 2033 / sight line 210 x 1710

GLAZING: Leaf and extender: Lakobel + antisol graphite

GLASS

G 56

- P100+** +10%
- BR** +£160
- H+** +20%
- ∞** +10%
- D**
- ALU** +£74
- L-ALU** +£38
- RX** +£125
- LL** +£228
- LW** +£139
- CZ** +£125
- ML** +£110
- P4** +£121
- RAL** +£120
- +£142
- H** +£210
- A** +£246

FITTINGS: AXA Niagara West handle + moving knob and AXA inox hinge caps painted RAL 9005



Types of glazing in the GLASS collection

Glazed units with black Lacobel glass are available in: RX-reflex, LW-Venetian mirror, LW-Venetian mirror, CZ-antrisol black, ML Opal, P4-safety glass or LL-Lakobel mirror (in which the whole surface will have a mirror-like appearance)

GLAZING: Lakoebel + antisol black

door width 80 / 90 / 100
glass size 300 x 2033 / sight line 180 x 1440

FITTINGS: PP handle 130cm and AXA inox hinge caps

GLASS
G 60

- +100% +10%
- BB +£160
- h+ +20%
- V% +10%
- ALU +£74
- L-ALU +£38
- CZ +£74
- RX +£125
- LL +£228
- LW +£139
- CZ +£125
- ML +£110
- PA +£121
- GLU +£120
- +£142
- H +£210
- A +£246

GLAZING: Lakoebel + antisol graphite

door width 80 / 90 / 100
glass size 60 x 2033 / sight line 20 x 1700

GLASS
G 43

- +100% +10%
- BB +£160
- h+ +20%
- V% +10%
- ALU +£74
- L-ALU +£38
- RX +£125
- LL +£228
- LW +£139
- CZ +£125
- ML +£110
- PA +£121
- GLU +£120
- +£142
- H +£210
- A +£246

GLAZING: Lakoebel + antisol graphite

door width 80 / 90 / 100
glass size 925 x 55 / sight line 510 x 35

GLASS
G 41

- +100% +10%
- BB +£160
- h+ +20%
- V% +10%
- ALU +£71
- L-ALU +£38
- RX +£125
- LL +£228
- LW +£139
- CZ +£125
- ML +£110
- PA +£121
- GLU +£120
- +£142
- H +£210
- A +£246



What's the difference between the types of glass available?

Antisol is solar control glass. The glass is delicately tinted with a shade of brown, which acts to reduce the transmittance of solar energy. Because of this, it prevents the room from overheating and protects items that are sensitive to ultraviolet radiation.

Reflex (stopsol) is a glass with enhanced sunlight control. This glass is visually attractive and provides privacy. This privacy is obtained by applying metal oxides to one side of the glass. Someone on the lighter side of the mirror glass can only see their reflection but remain visible to anyone on the darker side. Objects on the darker side only become visible only when that person gets close to the glass.

d4 width 150 (50+100)
glass 150 x 2033 / sight line 74 x 374 x 3 pcs.

door width 80 / 90 / 100
glass size 150 x 2033 / sight line 74 x 374 x 3 pcs.

GLAZING: Leaf and extender: Lakobel + antisol black

FITTINGS: PP handle 135cm and AXA inox hinge caps

GLASS

- G 62**
- P100+** +10%
- ES** + £160
- W*** +20%
- V** +10%
- I**
- II**
- ALU** + £71
- L-ALU** + £38
- RK** + £125
- LL** + £228
- LW** + £139
- DZ** + £125
- ML** + £110
- PA** + £121
- RAL** + £120
- + £142
- H** + £210
- A** + £246

What's the difference between the types of glass available?



Venetian (Phoenician) mirror - is glass covered with metal oxide on both sides. It is usually used as a partition between rooms, one of which is dark. On the lighter side of the mirror, a person can see their reflection and is visible to people on the other side.

Milk glass - is a glass that is covered with a satin-matte varnish on one side for effect - the glass "transmits" light but remains opaque.

P4 - consists of two panes of clear glass with a security film between them. Thanks to this film, the glass doesn't shatter when broken. There will simply be a crack at the point of impact. P4 glass is only available in clear.

INOX

The wide variety of choice in the INOX collection allows us to fulfill the expectations of discerning customers who value the sublime quality of stainless steel used in this range.

width 138 (38+100)

door width 80 / 90 / 100
glass size 180 x 1720

GLAZING: Antisol black

INOX
I 18

- +10%
- + £160
- +20%
- +10%
- + £103
- + £74
- + £38
- + £74
- + £125
- + £139
- + £125
- + £125
- + £110
- + £121
- + £120
- + £142
- + £210
- + £246

FITTINGS: KW Pull handle 40cm and AXA inox hinge caps

d4 width 190 (45+100+45)
glass size 240 x 1620

GLAZING: Sash and side panels: Antisol black

FITTINGS: PP handle 162cm and AXA inox hinge caps

door width 80 / 90 / 100
glass size 120 x 1620

INOX

I 19

- +10%
- +£160
- +20%
- +10%
- +£103
- +£74
- +£38
- +£74
- +£125
- +£139
- +£125
- +£110
- +£121
- +£120
- +£142
- +£210
- +£246

GLAZING: Antisol graphite + trim

FITTINGS: KW Pull handle 60cm and AXA inox hinge caps

door width 80 / 90 / 100
glass size 140 x 1284

INOX

I 20

- +10%
- +£160
- +20%
- +10%
- +£103
- +£74
- +£38
- +£74
- +£125
- +£139
- +£125
- +£110
- +£121
- +£120
- +£142
- +£210
- +£246

d4 width 145 (45+100)

GLAZING: Antisol graphite + trim

FITTINGS: PP handle 103cm, AXA hinge caps and steel elements painted in RAL 9005

door width 80 / 90 / 100
glass size 120 x 1224

INOX

I 21

- +10%
- +£160
- +20%
- +10%
- +£103
- +£74
- +£38
- +£74
- +£125
- +£139
- +£125
- +£110
- +£121
- +£120
- +£142
- +£210
- +£246

d3 width 150 (50+100)
glass size 380 x 1980

GLAZING: Antisol black + trim

FITTINGS: PP handle 103cm, AXA hinge caps and steel elements painted in RAL 9005

door width 80 / 90 / 100

INOX

I 22

- +10%
- +£160
- +20%
- +10%
- +£103
- +£74
- +£38
- +£74
- +£125
- +£139
- +£125
- +£110
- +£121
- +£120
- +£142
- +£210
- +£246

d3 width 145 (45+100)
glass size 330 x 1980

door width 80 / 90 / 100
glass size 510 x 60

GLAZING: Sash: Black, Antisol, Extra bed: Black, Antisol + firm

FITTINGS: PP handle 142cm and AXA inox hinge caps



INOX

I 32

- +10%
- + £160
- +20%
- +10%
- + £103
- + £74
- + £38
- + £74
- + £125
- + £139
- + £125
- + £110
- + £121
- + £120
- + £142
- + £210
- + £246



Can glass with decorative trim be used in combination with RX, LW ML or P4 glass?

Yes, when ordering Homeefe Doors, you have the option to combine different types of glass. For example, for the doors illustrated above: INOX004 - transparent horizontal stripes can be combined with REFLEX glass and anti-burglary P4 added.

door width 80 / 90 / 100
glass size 50 x 1400



INOX I 10

- +10%
- +£160
- +20%
- +10%
- +£103
- +£74
- +£38
- +£74
- +£125
- +£139
- +£125
- +£110
- +£121
- +£120
- +£142
- +£210
- +£246

GLAZING: Antisol graphite + trim

FITTINGS: PP handle 147cm and AXA inox hinge caps

door width 80 / 90 / 100
glass size 80 x 1470



INOX I 13

- +10%
- +£160
- +20%
- +10%
- +£103
- +£74
- +£38
- +£74
- +£125
- +£139
- +£125
- +£110
- +£121
- +£120
- +£142
- +£210
- +£246

door width 80 / 90 / 100
glass size 60 x 1400



INOX I 02

- +10%
- +£160
- +20%
- +10%
- +£103
- +£74
- +£38
- +£74
- +£125
- +£139
- +£125
- +£110
- +£121
- +£120
- +£142
- +£210
- +£246

d2 width 145 (100+45)
glass size 330 x 1590



INOX I 04

- +10%
- +£160
- +20%
- +10%
- +£103
- +£74
- +£38
- +£74
- +£125
- +£139
- +£125
- +£110
- +£125
- +£120
- +£142
- +£210
- +£246

GLAZING: Wing and extension: Antisol graphite + trim

FITTINGS: AXA Haga handle and AXA hinge caps and painted steel RAL 9005

door width 80 / 90 / 100
glass size 140 x 1590



INOX I 05

- +10%
- +£160
- +20%
- +10%
- +£103
- +£74
- +£38
- +£74
- +£120
- +£139
- +£125
- +£110
- +£125
- +£120
- +£142
- +£210
- +£246

GLAZING: Wing and extension: Antisol graphite + trim



How tall can doors without a transom be?

We manufacture frame-and-panel doors with a maximum height of 210 cm, and panel doors up to 220cm per single leaf, width not exceeding 100cm ("90")

door width 80 / 90 / 100
glass size 140 x 1590

GLAZING: Antisol graphite + trim

FITTINGS: PP handle 150cm and AXA inox hinge caps

INOX I 06

- +10%
- +£160
- +20%
- +10%
- +£103
- +£74
- +£38
- +£74
- +£120
- +£139
- +£125
- +£110
- +£121
- +£120
- +£142
- +£210
- +£246

door width 80 / 90 / 100
glass size 160 x 1540

GLAZING: Antisol graphite + trim

FITTINGS: GP handle 150cm and AXA inox hinge caps and painted steel RAL 9005

INOX I 16

- +10%
- +£160
- +20%
- +10%
- +£103
- +£74
- +£38
- +£74
- +£120
- +£139
- +£125
- +£110
- +£121
- +£120
- +£142
- +£210
- +£246

door width 80 / 90 / 100
glass size 140 x 265

INOX I 17

- +10%
- +£160
- +20%
- +10%
- +£103
- +£74
- +£38
- +£74
- +£120
- +£139
- +£125
- +£110
- +£121
- +£120
- +£142
- +£210
- +£246

d4 width 145 (45+100)
glass size 240 x 1680

door width 80 / 90 / 100
glass size 280 x 1680

FITTINGS: PP handle 140cm and AXA inox hinge caps

INOX I 14

- +10%
- +£160
- +20%
- +10%
- +£103
- +£74
- +£38
- +£74
- +£125
- +£139
- +£125
- +£110
- +£121
- +£120
- +£142
- +£210
- +£246

d3 width 150 (50+100)
glass size 380 x 1680

door width 80 / 90 / 100
glass size 100 x 1700

GLAZING: Door leaf: Antisol black Extension: Antisol black + trim

FITTINGS: PP handle 170cm and AXA inox hinge caps

INOX I 25

- +10%
- +£160
- +20%
- +10%
- +£103
- +£74
- +£38
- +£74
- +£125
- +£139
- +£125
- +£110
- +£121
- +£120
- +£142
- +£210
- +£246

d4 width 150 (50+100)
glass size 90 x 1300

door width 80 / 90 / 100
glass size 90 x 1300

GLAZING: Antisol black

FITTINGS: PP handle 130cm and AXA inox hinge caps

INOX
I 28

- I100+** +10%
- BB** +£160
- b+** +20%
- ∞** +10%
- D** +£103
- ALU** +£74
- L-ALU** +£38
- CZ INOX** +£74
- RX** +£125
- LL** +£139
- LW** +£125
- CZ** +£110
- ML** +£121
- PA** +£121
- ØAL** +£120
- +£142
- H** +£210
- A** +£246

d4 width 160 (30+100+30)

door width 80 / 90 / 100
glass size 140 x 1590

GLAZING: Antisol black + trim

INOX
I 29

- I100+** +10%
- BB** +£160
- b+** +20%
- ∞** +10%
- D** +£103
- ALU** +£74
- L-ALU** +£38
- CZ INOX** +£74
- RX** +£120
- LL** +£139
- LW** +£125
- CZ** +£110
- ML** +£121
- PA** +£121
- ØAL** +£120
- +£142
- H** +£210
- A** +£246

d3 width 150 (50+100)
glass size 380 x 1980

door width 80 / 90 / 100

GLAZING: Antisol black + trim

FITTINGS: PP handle 70cm and AXA inox hinge caps

INOX
I 31

- I100+** +10%
- BB** +£160
- b+** +20%
- ∞** +10%
- D** +£103
- ALU** +£74
- L-ALU** +£38
- CZ INOX** +£74
- RX**
- LL**
- LW**
- CZ**
- ML**
- PA**
- ØAL** +£120
- +£142
- H** +£210
- A** +£246

d3 width 150 (50+100)
glass size 380 x 1980

door width 80 / 90 / 100

GLAZING: Antisol black + trim

FITTINGS: AXA Niagara West handle, AXA hinge caps and steel elements painted in RAL 9005

INOX
I 30

- I100+** +10%
- BB** +£160
- b+** +20%
- ∞** +10%
- D** +£103
- ALU** +£74
- L-ALU** +£38
- CZ INOX** +£74
- RX**
- LL**
- LW**
- CZ**
- ML**
- PA**
- ØAL** +£120
- +£142
- H** +£210
- A** +£246

d4 width 150 (100+50)
glass size 140 x 1590

door width 80 / 90 / 100
glass size 140 x 1590

GLAZING: Leaf and extender: Antisol graphite + trim

FITTINGS: AXA Niagara West handle, AXA hinge caps and steel elements painted in RAL 9005

INOX 3D

I 102

- I102** +10%
- BB** + £160
- D+** +20%
- V** +10%
- D**
- I** + £210
- ALU** + £74
- L-ALL** + £38
- CZ** + £74
- RX** + £125
- LE**
- LW** + £139
- CZ** + £125
- ML** + £110
- PA** + £121
- RAL** + £120
- + £142
- H** + £210
- A** + £246



What is INOX and INOX 3D?

These are Homeefe doors with parts made of stainless steel, usually installed on doors situated on the exterior of a building. There is also the option to install them both internally and externally. The INOX 3D door has an additional convex stainless steel part and flat trim design.



door width 80 / 90 / 100
glass size 140 x 1590



INOX 3D

I 100

- +10%
- +£160
- +20%
- +10%
- +£210
- +£74
- +£38
- +£74
- +£125
- +£139
- +£125
- +£110
- +£121
- +£120
- +£142
- +£210
- +£246

door width 80 / 90 / 100
glass size 140 x 1590



INOX 3D

I 101

- +10%
- +£160
- +20%
- +10%
- +£210
- +£74
- +£38
- +£74
- +£125
- +£139
- +£125
- +£110
- +£121
- +£120
- +£142
- +£210
- +£246

GLAZING: Antisol graphite + trim

door width 80 / 90 / 100
glass size 140 x 1590



INOX 3D

I 103

- +10%
- +£160
- +20%
- +10%
- +£210
- +£74
- +£38
- +£74
- +£125
- +£139
- +£125
- +£110
- +£121
- +£120
- +£142
- +£210
- +£246

door width 80 / 90 / 100
glass size 85 x 1610



INOX 3D

I 105

- +10%
- +£160
- +20%
- +10%
- +£210
- +£74
- +£38
- +£74
- +£125
- +£139
- +£125
- +£110
- +£121
- +£120
- +£142
- +£210
- +£246

door width 80 / 90 / 100
glass size 280 x 1660



INOX 3D

I 106

- +10%
- +£160
- +20%
- +10%
- +£210
- +£74
- +£38
- +£74
- +£125
- +£139
- +£125
- +£110
- +£121
- +£120
- +£142
- +£210
- +£246

door width 80 / 90 / 100
glass size 120 x 353



INOX 3D

I 107

- +10%
- +£160
- +20%
- +10%
- +£210
- +£74
- +£38
- +£74
- +£125
- +£139
- +£125
- +£110
- +£121
- +£120
- +£142
- +£210
- +£246



Can purchasing a Homeefe door save me money?

Yes, if you are thinking about how to save money on heating your home, it's worth investing in a panel door with increased thickness - up to 88mm with a thermal coefficient of $U_d = 0.79W/m^2k$ for solid doors and $U_d = 0.95W/m^2 K$ for glazed doors.

Future

The unique, distinctive design of the Future collection allows for patterns and designs to be matched perfectly to a wide range of architectural features. Ranging from the simpler shapes of the Future F30 to the more enigmatic and innovative shapes of the Future line - model F13.





































d3 width 210 (65+100+45)
glass size 530 x 1980

door width 80 / 90 / 100
glass size 330 x 1980 **d3**

GLAZING: Antisol black + trim

FITTINGS: KW handle 40cm + Top plate Ceres solo + AXA hinge inox

FUTURE
F 13

-  +10%
-  + £160
-  +20%
-  +10%
- 
-  + £74
-  + £38
- 
- 
- 
- 
- 
- 
- 
- 
- 
- 
- 
- 
- 
- 
- 
- 
- 
- 
- 
- 
- 
- 
- 
- 
- 
- 
- 
- 
- 
- 



How does an automatic lock work?

After manually closing the door with the handle, the upper and lower bolts automatically retract by 1 cm (magnets attract the latches into the holes on the strike plate). Turning the key locks all points. It's possible to order a door without an upper lock, meaning locking would be via the basic lock only.



d3 width 170 (35+100+35)
glass size 230 x 1980

door width 80 / 90 / 100 **d4**

GLAZING: Antisol black + film

FITTINGS: Pull handle PP 190 and AXA inox hinge caps

FUTURE
F 12

- +10%
- +£160
- +20%
- +10%
- +£74
- +£38
-
-
- +£120
- +£142
- +£210
- +£246

door width 80 / 90 / 100
glass size 90 x 1600

FUTURE
F 27

- +10%
- +£160
- +20%
- +10%
- +£74
- +£38
- +£125
-
- +£138
- +£125
- +£110
- +£121
- +£120
- +£142
- +£210
- +£246

FITTINGS: Pull handle KW 160 and AXA inox hinge caps

d4 width 145 (45+100)
glass size 180 x 180

door width 80 / 90 / 100
glass size 180 x 180

FITTINGS: KW handle 40cm and AXA inox hinge caps

FUTURE
F 15

- +10%
- +£160
- +20%
- +10%
- +£74
- +£38
- +£125
-
- +£139
- +£125
- +£120
- +£121
- +£120
- +£142
- +£210
- +£246

door width 80 / 90 / 100
glass size 288 x 1620 x 90

FUTURE
F 16

- +10%
- +£160
- +20%
- +10%
- +£74
- +£38
- +£125
-
- +£139
- +£125
- +£120
- +£121
- +£120
- +£142
- +£210
- +£246

FITTINGS: Pull handle PP 120 and AXA inox hinge caps

d3 width 150 (50+100)
glass size 380 x 1980

n6 height 260 (50+210)
glass size 1380 x 380

door width 80 / 90 / 100
glass size 180 x 1590

GLAZING: Wing and extension: Antisol black + trim Upper sidelight: Antisol black + full trim

FITTINGS: P handle 160cm and AXA hinge inox



FUTURE

F 25

- +10%
- + £160
- +20%
- +10%
-
- + £74
- + £38
- + £125
-
- + £139
- + £125
- + £110
- + £121
- + £120
- + £142
- + £210
- + £246

d3 width 150 (50+100)
glass size 380 x 1980

door width 80 / 90 / 100
glass size 230 x 1340

GLAZING: Wing, Antisol graphite Extra bed: Antisol graphite + trim

FITTINGS: Pull handle PP 80cm and AXA inox hinge caps

FUTURE

F 31

- >100+ +10%
- BB +£160
- h+ +20%
- V +10%
- ALU +£74
- L-ALU +£38
- RX +£125
- LW +£139
- GZ +£125
- ML +£110
- P4 +£121
- RAL +£120
- +£142
- H +£210
- A +£246

d4 width 150 (50+100)
glass size 230 x 1770

door width 80 / 90 / 100
glass size 325 x 1770

GLAZING: Leaf and extender: Antisol black + trim

FITTINGS: Pull handle PP 190 and AXA Niagara West handle + moving knob and AXA hinge caps

FUTURE

F 22

- >100+ +10%
- BB +£160
- h+ +20%
- V +10%
- ALU +£74
- L-ALU +£38
- RX +£125
- LW +£139
- GZ +£125
- ML +£110
- P4 +£121
- RAL +£120
- +£142
- H +£210
- A +£246

d3 width 160 (60+100)
glass size 480 x 1980

door width 80 / 90 / 100

GLAZING: Antisol black +trim

FITTINGS: Pull handle PP 190cm and AXA inox hinge caps

FUTURE

F 17

- >100+ +10%
- BB +£160
- h+ +20%
- V +10%
- ALU +£74
- L-ALU +£38
- RX +£125
- LW +£139
- GZ +£125
- ML +£110
- P4 +£121
- RAL +£120
- +£142
- H +£210
- A +£246

d3 width 130 (30+100)
glass size 180 x 1980

door width 80 / 90 / 100
glass size 440 x 60

DOOR COLOURS: Door frame and frame extender RAL 7016 (antracite) Door leaf gold oak, glazing in the frame extender gold oak

FUTURE

F 18

- >100+ +10%
- BB +£160
- h+ +20%
- V +10%
- ALU +£74
- L-ALU +£38
- RX +£125
- LW +£139
- GZ +£125
- ML +£120
- P4 +£142
- RAL +£120
- +£142
- H +£210
- A +£246

d4 width 150 (50+100) door width 80 / 90 / 100 glass size 160 x 1760

GLAZING: Antisol black + trim

FITTINGS: Pull handle PP 100cm and AXA inox hinge caps

FUTURE F 32

- P100+** +10%
- BB** +£160
- H+** +20%
- V** +10%
- H**
- L**
- ALU** +£74
- L-ALU** +£38
- RX** +£125
- L**
- LW** +£139
- CZ** +£125
- ML** +£110
- PA** +£121
- RAL** +£120
- +£142
- H** +£210
- A** +£246

d3 width 150 (50+100) door width 80 / 90 / 100 glass size 380 x 1980

GLAZING: Antisol black + trim

FITTINGS: Pull handle PP 140cm and AXA inox hinge caps

FUTURE F 01

- P100+** +10%
- BB** +£160
- H+** +20%
- V** +10%
- H**
- L**
- ALU** +£74
- L-ALU** +£38
- RX** +£125
- L**
- LW** +£139
- CZ** +£125
- ML** +£110
- PA** +£121
- RAL** +£120
- +£142
- H** +£210
- A** +£246

d3 width 150 (50+100) door width 80 / 90 / 100 glass size 480 x 1980

GLAZING: Antisol black

FITTINGS: Pull handle LM 190cm and AXA inox hinge caps painted in RAL 9005

FUTURE F 33

- P100+** +10%
- BB** +£160
- H+** +20%
- V** +10%
- H**
- L**
- ALU** +£74
- L-ALU** +£38
- RX**
- L**
- LW**
- CZ**
- ML**
- PA**
- RAL** +£120
- +£142
- H** +£210
- A** +£246

width 150 (50+100) door width 80 / 90 / 100 glass size 140 x 1590

GLAZING: Antisol graphite + trim

FUTURE F 04

- P100+** +10%
- BB** +£160
- H+** +20%
- V** +10%
- H**
- L**
- ALU** +£74
- L-ALU** +£38
- RX** +£125
- L**
- LW** +£139
- CZ** +£125
- ML** +£110
- PA** +£121
- RAL** +£120
- +£142
- H** +£210
- A** +£246



How does hook lock work?

After closing the door with the handle, you must turn the key. This causes the hook(s) to slide out from the lock and results in the door locking. It's possible to order a door without an upper lock, meaning locking would be via the basic lock only.



door width 80 / 90 / 100
glass size 70 x 1700

FUTURE
F 26

- +10%
- +£160
- +20%
- +10%
- +£74
- +£38
- +£125
- +£139
- +£125
- +£110
- +£121
- +£120
- +£142
- +£210
- +£246

GLAZING: Antisol graphite + trim

FITTINGS: PP handle 120cm and AXA inox hinge caps

door width 80 / 90 / 100
glass size 160 x 1300

FUTURE
F 08

- +10%
- +£160
- +20%
- +10%
- +£74
- +£38
- +£125
- +£139
- +£125
- +£110
- +£121
- +£120
- +£142
- +£210
- +£246

GLAZING: Antisol graphite + trim

FITTINGS: PP handle 120cm and AXA inox hinge caps

door width 80 / 90 / 100
glass size 190 x 370

FUTURE
F 10

- +10%
- +£160
- +20%
- +10%
- +£74
- +£38
- +£125
- +£139
- +£125
- +£110
- +£121
- +£120
- +£142
- +£210
- +£246

GLAZING: Antisol graphite + trim

FITTINGS: PP handle 120cm and AXA inox hinge caps

d2 width 170 (70+100)
glass size 580 x 1788

door width 80 / 90 / 100
glass size 240 x 1460

FUTURE
F 11

- +10%
- +£160
- +20%
- +10%
- +£74
- +£38
- +£125
- +£139
- +£125
- +£110
- +£121
- +£120
- +£142
- +£210
- +£246

GLAZING: Antisol graphite + trim

FITTINGS: GP handle 150cm and AXA inox hinge caps

d4 width 150 (100+50)
glass size 220 x 220

door width 80 / 90 / 100
glass size 220 x 220

FUTURE
F 09

- +10%
- +£160
- +20%
- +10%
- +£74
- +£38
- +£125
- +£139
- +£125
- +£110
- +£121
- +£120
- +£142
- +£210
- +£246

GLAZING: Antisol graphite + trim

FITTINGS: PP handle 170cm and AXA inox hinge caps

Did you know that...?

When choosing a door with a pull handle, you can choose from three different ways of opening:
1. With a key 2. With a moveable knob/ key 3. With a button/ key

ZEBRANO

The exotic addition of Zebrano wood inserts, highlights the character of this range giving a sophisticated design. The Zebrano wood grain is best achieved by selecting light colours from the Homeefe Doors palette. When choosing darker colours, the grain will become less visible.



What is the purpose of an adjustable lock strike on the door frame?

Installed as standard on our doors, they maintain an even, well-regulated pressure between the door and seal. You can adjust the lightness of door closure to suit your preferences.

wood: ZEBRANO
door width 80 / 90 / 100
glass size 110 x 1555

GLAZING: Antisol black + trim

ZEBRANO Z 13

- +10%
- +£160
- +20%
- +10%
-
- +£71
- +£348
- +£125
-
- +£139
- +£125
- +£110
- +£121
- +£120
- +£142
- +£210
- +£246

wood: ZEBRANO
door width 80 / 90 / 100
glass size 120 x 1455

GLAZING: Antisol graphite + trim

ZEBRANO Z 06

- +10%
- +£160
- +20%
- +10%
-
- +£74
- +£38
- +£125
-
- +£139
- +£125
- +£110
- +£121
- +£120
- +£142
- +£210
- +£246

wood: ZEBRANO
door width 80 / 90 / 100
glass size 470 x 80

FITTINGS: PP handle 150cm and AXA inox hinge caps

ZEBRANO Z 02

- +10%
- +£160
- +20%
- +10%
-
- +£74
- +£38
- +£125
-
- +£139
- +£125
- +£110
- +£121
- +£120
- +£142
- +£210
- +£246

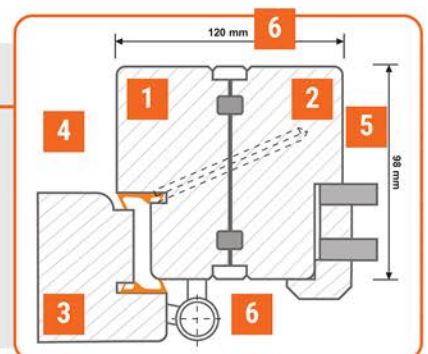

How to install an add-on or a transom:

- 1** Door sill
- 2** Sill addition
- 3** Door leaf
- 4** Screws for mounting frames 4.5x77mm (without a head)
- 5** Colourless silicone
- 6** Cover strip

14 width 140 (40+100)
glass size 173 x 173

door width 80 / 90
glass size 173 x 173



RP

RP 54

- >100+** +10%
- B2** +£124
- V** +10%
- ALU** +£74
- L-ALU** +£38
- RX** +£125
- LW** +£139
- CZ** +£125
- ML** +£110
- P4** +£121
- RAL** +£120
- H** +£142
- H** +£210
- A** +£246

door width 90 / 100
glass size 192 x 1540

GLAZING: Antisol graphite + trim (beweile)

RP
RP 02

- +10%
- +£124
- +10%
-
-
- ALU +£74
- L-ALU +£38
- RX +£125
-
-
- LW +£139
- CZ +£125
- ML +£110
- P4 +£121
- RAL +£120
- +£142
- RH +£210
- RA +£246

door width 90 / 100
glass size 630 x 320

RP
RP 51

- +10%
- +£124
- +10%
-
-
- ALU +£74
- L-ALU +£38
- RX +£125
-
-
- LW +£139
- CZ +£125
- ML +£110
- P4 +£121
- RAL +£120
- +£142
- RH +£210
- RA +£246

door width 90 / 100
glass size 120

RP
RP 52

- +10%
- +£124
- +10%
-
-
- ALU +£74
- L-ALU +£38
- RX +£125
-
-
- LW +£139
- CZ +£125
- ML +£110
- P4 +£121
- RAL +£120
- +£142
- RH +£210
- RA +£246

d9 width 131 (31+100)
glass size 192 x 1540

GLAZING: Antisol graphite + trim (beweile)

door width 90 / 100
glass size 192 x 1540

RP
RP 03

- +10%
- +£124
- +10%
-
-
- ALU +£74
- L-ALU +£38
- RX +£125
-
-
- LW +£139
- CZ +£125
- ML +£110
- P4 +£121
- RAL +£120
- +£142
- RH +£210
- RA +£246

d4 width 140 (40+100)
glass size 140 x 140

door width 80 / 90
glass size 43 x 649

RP
RP 56

- +10%
- +£124
- +20%
- +10%
-
-
- ALU +£74
- L-ALU +£38
- RX +£125
-
-
- LW +£139
- CZ +£125
- ML +£110
- P4 +£121
- RAL +£120
- +£142
- RH +£210
- RA +£246



Are handles and cylinders included in the price of the door?

We offer a wide range of door handles and knobs. These are optional extras available for an additional cost. The price list is found on pages 64,68,69.

door width 80 / 90 / 100
glass size 120 x 535

GLAZING: Antisol graphite + trim (bevele)



RP
RP 13

- +10%
- +£124
- +10%
-
-
- +£74
- +£38
- +£125
- +£139
- +£125
- +£110
- +£121
- +£120
- +£142
- +£210
- +£246

door width 90
glass size 103 x 913

GLAZING: Antisol graphite + trim (bevele)



RP
RP 16

- +10%
- +£124
- +10%
-
-
- +£74
- +£38
- +£125
- +£139
- +£125
- +£110
- +£121
- +£120
- +£142
- +£210
- +£246

door width 80 / 90 / 100
glass size 10 x 200

GLAZING: Antisol graphite + trim (bevele)



RP
RP 24

- +10%
- +£124
- +10%
-
-
- +£74
- +£38
- +£125
- +£139
- +£125
- +£110
- +£121
- +£120
- +£142
- +£210
- +£246

d10 width 140 (40+100)
glass size 100 x 1088

door width 90 / 100
glass size (100) 521 x 1088



RP
RP 21

- +10%
- +£124
- +10%
-
-
- +£74
- +£38
- +£125
- +£139
- +£125
- +£110
- +£121
- +£120
- +£142
- +£210
- +£246

door width 80 / 90 / 100
glass size 60 x 1476

width 145 (45+100)
glass size 60 x 1476 **d10**



RP
RP 22

- +10%
- +£124
- +10%
-
-
- +£74
- +£38
- +£125
- +£139
- +£125
- +£110
- +£121
- +£120
- +£142
- +£210
- +£246



For doors to look like new after construction has completed.

Do you want your door to look as good as the day you bought it ready for your housewarming? Here are a few secrets to doing exactly that. Firstly, the door should be installed after completing all wet construction works inside the building (plastering, screeding, finishing coats). In this way, you avoid any reaction between the excess moisture or construction chemicals with the wood used. You will also avoid accidental dents and scratches by the team working on the construction of the house of your dreams.

door width 80 / 90 / 100
glass size 310 - 551 x 60

RP
RP 25

- +10%
- +£124
- +10%
- +£74
- +£38
- +£125
- +£139
- +£125
- +£110
- +£121
- +£120
- +£142
- +£210
- +£246

door width 90 / 100
glass size 188 - 320 x 55

RP
RP 26

- +10%
- +£124
- +10%
- +£74
- +£38
- +£125
- +£139
- +£125
- +£110
- +£121
- +£120
- +£142
- +£210
- +£246

door width 80 / 90 / 100
glass size 220 x 1220

RP
RP 27

GLAZING: Antisol graphite + trim (bevele)

- +10%
- +£124
- +10%
- +£74
- +£38
- +£125
- +£139
- +£125
- +£110
- +£121
- +£120
- +£142
- +£210
- +£246

d9 width 145 (100+45)
glass size 330 x 1620

RP
RP 29

GLAZING: Antisol graphite + trim

- +10%
- +£124
- +10%
- +£74
- +£38
- +£125
- +£139
- +£125
- +£110
- +£121
- +£120
- +£142
- +£210
- +£246

door width 80 / 90 / 100
glass size 125 x 1250

d10 width 150 (100+50)
glass size 200 x 60

RP
RP 35

- +10%
- +£124
- +10%
- +£74
- +£38
- +£125
- +£139
- +£125
- +£110
- +£121
- +£120
- +£142
- +£210
- +£246

door width 80 / 90 / 100
glass size 200 x 60



For doors to look like new after construction has completed:

Secondly, ensure that the door has a canopy or is mounted into a recess, which will increase the durability of the door as well as protecting it against UV rays and any other inclement weather conditions (e.g. rain or snow). A door is similar to a car, the paintwork of a car looks fresher for longer when kept in a garage compared to one left outdoors. Thirdly, the purchase of suitable door care products will keep the door looking as good as new for many years.

door width 90 / 100
glass size 10 x 170



- RP**
RP 30
- +10%
 - +£124
 - +10%
 -
 -
 - +£74
 - +£38
 - +£125
 -
 - +£139
 - +£125
 - +£110
 - +£121
 - +£120
 - +£142
 - +£210
 - +£246

door width 90 / 100
glass size 170 x 920

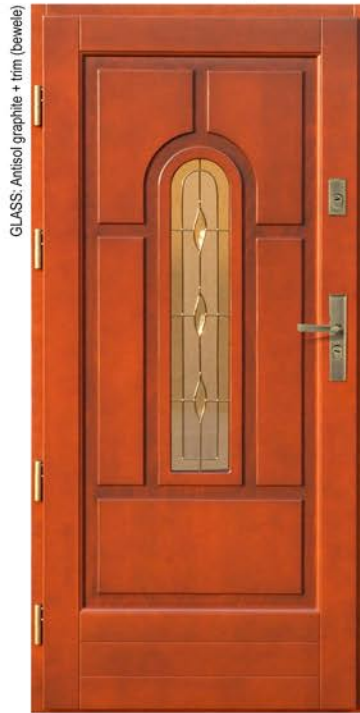

- RP**
RP 36
- +10%
 - +£124
 - +10%
 -
 -
 - +£74
 - +£38
 - +£125
 -
 - +£139
 - +£125
 - +£110
 - +£121
 - +£120
 - +£142
 - +£210
 - +£246

door width 80 / 90 / 100
glass size 100 x 1396



- RP**
RP 38
- +10%
 - +£124
 - +10%
 -
 -
 - +£74
 - +£38
 - +£125
 -
 - +£139
 - +£125
 - +£110
 - +£121
 - +£120
 - +£142
 - +£210
 - +£246

d10 width 150 (50+100)
glass size 70 x 1485



- RP**
RP 32
- +10%
 - +£124
 - +10%
 -
 -
 - +£74
 - +£38
 - +£125
 -
 - +£139
 - +£125
 - +£110
 - +£121
 - +£120
 - +£142
 - +£210
 - +£246

door width 80 / 90 / 100
glass size 70 x 1485

d10 width 139 (100+39)
glass size 130 x 502

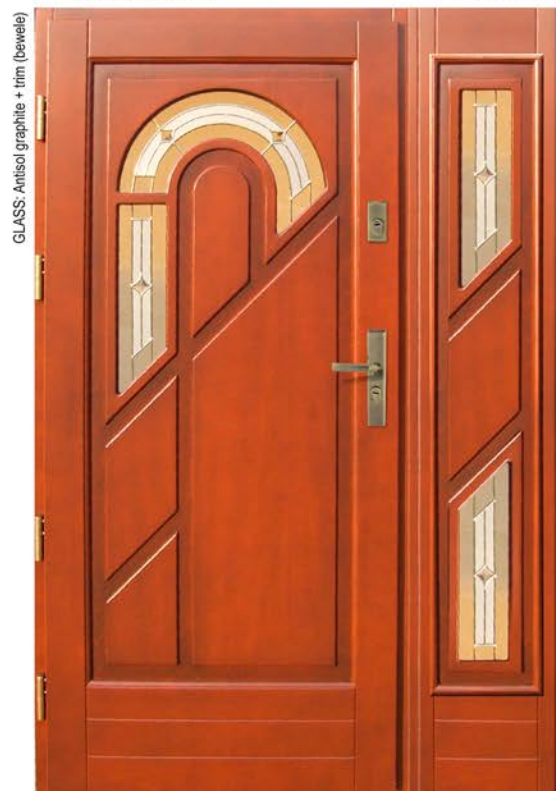

- RP**
RP 34
- +10%
 - +£124
 - +10%
 -
 -
 - +£74
 - +£38
 - +£125
 -
 - +£139
 - +£125
 - +£110
 - +£121
 - +£120
 - +£142
 - +£210
 - +£246

door width 90
glass size 130



How can you save when buying a set of fittings?

By choosing ready-made sets, which include the AXA handle + upper plate + Wilka cylinders - you save 10% off the value of the fittings! In addition, we drill all mounting holes for free!

d10 width 150 (100+50)
glass size 10 - 230 x 1180

door width 80 / 90 / 100
glass size 10 - 230 x 1180

GLASS: Antisol graphite + trim (beweile)



RP

RP 37

-  +10%
-  +£124
-  +10%
-  +£74
-  +£38
-  +£125
-  +£139
-  +£125
-  +£110
-  +£121
-  +£120
-  +£142
-  +£210
-  +£246



Which upper transom?

Glass - a transom consisting of a frame in which a glazing unit is installed and sealed with a covering strip.

Fixed sash - a transom consisting of a sash in the style of the door, permanently fitted into the frame.

door width 80 / 90 / 100
glass size 50 x 1436



- RP
RP 42
- +10%
 - +£124
 - +10%
 - +£74
 - +£38
 - +£125
 - +£139
 - +£125
 - +£110
 - +£121
 - +£120
 - +£142
 - +£210
 - +£246

door width 80 / 90 / 100
glass size 370 x 60



- RP
RP 44
- +10%
 - +£124
 - +10%
 - +£71
 - +£38
 - +£125
 - +£139
 - +£125
 - +£110
 - +£121
 - +£120
 - +£142
 - +£210
 - +£246

door width 80 / 90 / 100
glass size 173 x 173



- RP
RP 48
- +10%
 - +£124
 - +10%
 - +£74
 - +£38
 - +£125
 - +£139
 - +£125
 - +£110
 - +£121
 - +£120
 - +£142
 - +£210
 - +£246

d9 width 240 (70+100+70)
glass size 580 x 1620

GLASS: Antisol graphite + trim



- RP
RP 41
- +10%
 - +£124
 - +10%
 - +£74
 - +£38
 - +£125
 - +£139
 - +£125
 - +£110
 - +£121
 - +£120
 - +£142
 - +£210
 - +£246

door width 80 / 90 / 100
glass size 551 x 60



- RP
RP 43
- +10%
 - +£124
 - +10%
 - +£74
 - +£38
 - +£125
 - +£139
 - +£125
 - +£110
 - +£121
 - +£120
 - +£142
 - +£210
 - +£246

Which side extension? (1/2)



- **Glass** - an extension consisting of a frame in which a glazing unit is installed and sealed with a covering strip.
- **Glass with trim** - this is an extra unit constructed in the same way as the glass extension. The difference is that decorative trim is applied to the glass (e.g. bevels, stripes).

d9 width 145 (100+45)
glass size 330 x 1620

door width 80 / 90 / 100
glass size 140 x 1272

GLASS: Antisol graphite + trim

RP
RP 47

- >100+ +10%
- B2 +£124
- V +10%
- ALU +£74
- L-ALU +£38
- RX +£125
- LL +£139
- CZ +£125
- ML +£110
- P4 +£121
- BAL +£120
- +£142
- H +£210
- A +£246

d10 width 145 (100+45)
glass size 100 x 246

door width 80 / 90 / 100
glass size 100 x 246

RP
RP 50

- >100+ +10%
- B2 +£124
- V +10%
- ALU +£74
- L-ALU +£38
- RX +£125
- LL +£139
- CZ +£125
- ML +£110
- P4 +£121
- BAL +£120
- +£142
- H +£210
- A +£246

d4 width 180 (40+100+40)

door width 80 / 90
glass size 43 x 649

RP
RP 53

- >100+ +10%
- B2 +£124
- V +10%
- ALU +£74
- L-ALU +£38
- RX +£125
- LL +£139
- LW +£125
- B2 +£125
- ML +£110
- P4 +£121
- BAL +£120
- +£142
- H +£210
- A +£246

d10 width 180 (40+100+40)

door width 80 / 90
glass size 43 x 649

RP
RP 14

- >100+ +10%
- B2 +£124
- V +10%
- ALU +£74
- L-ALU +£38
- RX +£125
- LL +£139
- LW +£125
- CZ +£125
- ML +£110
- P4 +£121
- BAL +£120
- +£142
- H +£210
- A +£246

i Which side extension? (2/2)

- Door imitation (panel in frame) - an extension consisting of a frame in which a panel in the style of the door is installed and sealed with a covering strip.
- Fixed sash - an extension consisting of a sash in the style of the door, permanently fitted into the frame.

Now available for an additional cost you can choose to keep the classic look of a frame-and-panel door but manufactured using panel door technology. By choosing this, you gain an increased thickness of door (72mm to 78 mm or 88mm) and a better thermal performance.

All you need to do is choose your frame-and-panel door selection and add FUTURE RP range.

door width 80 / 90 / 100
glass size 380 x 730

GLASS: Antisol graphite + trim

RP
FRP 01

- +10%
- +£160
- +10%
- +£74
- +£38
- +£125
- +£139
- +£125
- +£110
- +£121
- +£120
- +£142
- +£210
- +£246

door width 80 / 90 / 100
glass size 380 x 730

GLASS: Antisol graphite + trim

RP
RP 01

- +10%
- +£124
- +10%
- +£71
- +£348
- +£125
- +£139
- +£125
- +£110
- +£121
- +£120
- +£142
- +£210
- +£246

EARTHQUAKE

d4 width 165 (100+65)
3 asymmetrical panes

door width 80 / 90 / 100
3 asymmetrical panes

door width 80 / 90 / 100
3 asymmetrical panes

GLASS: Venetian mirror



GLASS: Antisol black



EARTHQUAKE

E 01

- +10%
- +£160
- +20%
- +10%
- +£139
- +£74
- +£38
- +£74
- +£125
- +£139
- +£125
- +£110
- +£121
- +£120
- +£142
- +£210
- +£246

WOOD DOOR CARE PRODUCTS + HARDWARE



**INCLUDED
IN THE PRICE
OF THE DOOR**

Types of transom

- n0** Arched
- n1** Fixed leaf (in the door style)

Types of extra panels

- d2** Glazed
- d3** Glazed
- d4** Fixed leaf (in the door style)
- d11** Lakobel glazing
- ps1** - to widen the door frame (max 60 mm)

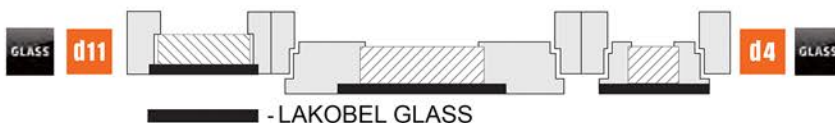

n0 n1 Fixed sash transom

Height (cm)	Width (cm)	Oak PLUS	Fiord	Loft	Application in glass	RX - reflex	LW - venetian mirror	CZ - black	ML - milk glass	P4 - secure	Arched lights	Aging
from 20 to 50	to 110	£475	+ £125	+ £160	+ £75	+ £100	+ £110	+ £100	+ £110	+ £110	+ £350	+ £160
from 20 to 50	from 111 to 150	£545	+ £160	+ £195	+ £95	+ £110	+ £125	+ £110	+ £130	+ £115	+ £405	+ £195
from 20 to 50	from 151 to 200	£725	+ £195	+ £230	+ £105	+ £125	+ £135	+ £125	+ £145	+ £135	+ £550	+ £230

d4 Fixed leaf (in the door style) - models: FRAME-PLATE RP INOX Future

Width (cm)	Height (cm)	Oak PLUS	Thickness 82mm	Thickness 88mm	Application in glass	RX - reflex	LW - venetian mirror	CZ - black	ML - milk glass	P4 - secure	h+ max 230 cm
from 25 to 50	to 210	£1050	+ £60	+ £75				surcharge as in the door			+20%
from 51 to 70	to 210	£1185	+ £85	+ £110				surcharge as in the door			+20%
from 71 to 90	to 210	£1225	+ £110	+ £150				surcharge as in the door			+20%

d4 Fixed leaf (in the door style) - models: EARTHQUAKE INOX 3D ZEBRANO GLASS FIORD Loft

Width (cm)	Height (cm)	Oak PLUS	Thickness 88mm	Fiord	Glass	Loft	Application in glass	RX - reflex	LW - venetian mirror	CZ - black	ML - milk glass	P4 - secure	h+ max 230 cm	Aging
from 25 to 50	to 210	£1170	+ £75	+ £70	+ £70	+ £105				surcharge as in the door			+20%	+ £245
from 51 to 70	to 210	£1310	+ £110	+ £105	+ £70	+ £140				surcharge as in the door			+20%	+ £280
from 71 to 90	to 210	£1355	+ £150	+ £140	+ £70	+ £175				surcharge as in the door			+20%	+ £315

Types of transom

- n5** Full
- n6** Glazed
- n7** Glazed with decorative trim

Types of extension

- d8** Glazed
- d9** Glazed with decorative trim
- d10** In the door style (panel in door frame)
- op1** band 60 x 9 mm linear metre £24⁵⁰
shape: 
- op2** band 20 x 22 mm linear metre £19⁵⁰
shape: 

3-PANE GLAZED UNITS
All transoms and extensions have 3 panes.



h+ +20% - price for an extra panel between 210-230cm - 20% of the panel value.

n5 n6 n7 Glazed transom (antisol graphite) or full

Height (cm)	Width (cm)	Oak PLUS	Loft	Application in glass	RX - reflex	LW - venetian mirror	CZ - black	ML - milk glass	P4 - secure	Arched lights	Aging
from 18 to 50	to 110	£350	+ £125	+ £75	+ £100	+ £110	+ £100	+ £115	+ £110	+ £350	+ £125
from 18 to 50	from 111 to 150	£460	+ £160	+ £95	+ £110	+ £125	+ £110	+ £130	+ £125	+ £405	+ £160
from 18 to 50	from 151 to 200	£635	+ £195	+ £105	+ £130	+ £135	+ £125	+ £145	+ £135	+ £550	+ £195

d2 d3 d8 d9 Glazed extension (antisol graphite) or full

Width (cm)	Height (cm)	Oak PLUS	Loft	Application in glass	RX - reflex	LW - venetian mirror	CZ - black	ML - milk glass	P4 - secure	h+ max 230cm	Aging	GLASS
from 25 to 50	to 210	£760	+ £160	+ £120	+ £135	+ £150	+ £135	+ £125	+ £140	+20%	+ £195	+ £410
from 51 to 70	to 210	£840	+ £195	+ £135	+ £160	+ £160	+ £160	+ £140	+ £150	+20%	+ £230	+ £460
from 71 to 90	to 210	£870	+ £230	+ £150	+ £165	+ £170	+ £165	+ £160	+ £160	+20%	+ £265	+ £515

d10 In the door style (panel in the door frame)

Height (cm)	Width (cm)	Oak PLUS	Application in glass	RX - reflex	LW - venetian mirror	CZ - black	ML - milk glass	P4 - secure
from 25 to 50	to 210	£905						surcharge as in the door
from 51 to 70	to 210	£1010						surcharge as in the door
from 71 to 90	to 210	£1050						surcharge as in the door

Price list and types of door pull handles

Length (cm)	Straight	Slanted	Curved	Square and Arc
				
				
60	£140	£160	£175	£160
80	£145	£165	£180	£165
100	£150	£170	£185	£170
120	£155	£175	£190	£175
150	£160	£180	£195	£180
170	£165	£185	£205	£185
190	£175	£195	£210	£195
200	£185	£200	£220	£200
220	£200	£220	£235	£220

Standard color: INOX

Folding doors
(only available for doors opening outwards)



100	£215
120	£230
150	£245
170	£255
190	£265
220	£295

Recessed



£315

* it is not possible to mount the upper insert which is recommended with a strip lock.

AXA CERES SOLO



Electric lock

Can't be combined with automatic strip lock

PRICE £110.00



The electric lock shown with standard lock (photo above) is hidden when used with a strip lock. Day/night function. For proper operation day/night function requires the installation of a door closer, see page 69.

AXA movable knob

Available with all AXA handles*



12 V Power supply



AXA SOLO 2 GAJA LOCK PLATE



*Not available with movable knob!

AXA SOLO 2 GAJA UPPER PLATE



Did you know?



This button is available with all types of handle. The button is fitted at handle height, allowing children and adults to open the door.

Doors with pull handle. How do they work? Which system should I choose?

1 First system:
Can only be opened from the outside with a key.
Only Axa Solo 2 Gaja fittings + Wilka class B or C inserts are available with this system. The advantage of this system is that it is the lowest priced option.

- The set includes:.**
- 1** pull handle (round or rectangular profile)
 - 2** Axa Solo 2 Gaja handle
 - 3** Wilka cylinder



2 Second system:
Can be opened with a key or a moveable knob.
The moving doorknob fits all Axa handles. Opening is via the knob mounted on the pull handle side or with a key. The advantage of this system is its versatility.

- The set includes:.**
- 1** pull handle (round or rectangular profile)
 - 2** Axa handle
 - 3** Wilka cylinder
 - 4** moveable knob



3 Third system:
Can be opened with an electric lock or motorised bolt. This method is available with two options:
[7] with a 4-hook lock - after pressing the button in the lock, the motorised bolt is released; after turning the key, the door is locked.
[8] with a motor-controlled lock - after pressing the button in the door handle, the lock engine activates and the door is unlocked.
After closing the door, it latches automatically at 3 points; when the key is turned, the door is locked. With this configuration, no motorised bolt is needed.

- The set includes:.**
- 1** pull handle (round or rectangular profile)
 - 2** Axa Solo 2 Gaja lock
 - 3** Wilka cylinder
 - 4** electric lock
 - 5** 12v door installation
 - 6** 12v power supply
 - 7** 4-point hook lock
 - 8** motorised lock

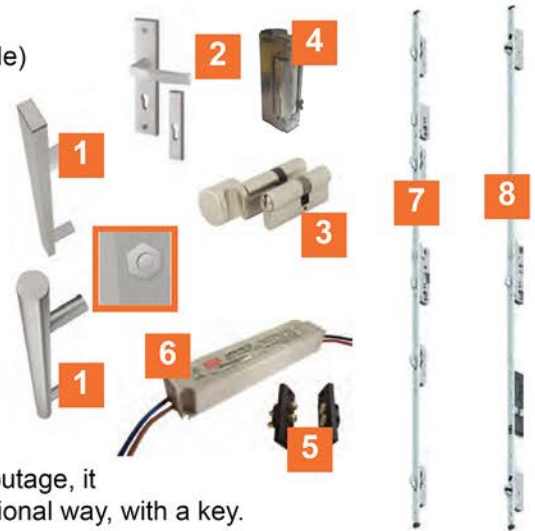

In the event of power failure or outage, it is still possible to open the traditional way, with a key. The advantage to this system is its convenience.

Fittings are painted in any RAL colour, choose from the following:

	+		+		+	
Pull handle		Lock + cylinder with knob		Axa caps		Threshold fittings
PRICE £50 ⁰⁰ for RAL		PRICE £60 ⁰⁰ for RAL		PRICE £30 ⁰⁰ for RAL		PRICE £45 ⁰⁰ for RAL

FUHR strip locks

Strike plate in standard

Automatic lock 92 mm
£245⁰⁰
Anti-burglary class RC2

4 - Hook lock 92 mm
£210⁰⁰
Anti-burglary class RC3

Automatic lock with 92mm motor recommended for use with a pull handle with button.
£880⁰⁰
**recommended for use with a pull handle with button*

Intelligent automatic lock with a 92mm motor
£1130⁰⁰
**recommended for use with IDENCOM and EKEY readers*

NAVKOM
Numeric keyboard



PRICE
£980⁰⁰

NAVKOM
Numeric keyboard



PRICE
£980⁰⁰

INDENCOM
Bluetooth & keyboard



PRICE
£1100⁰⁰

NAVKOM
Fingerprint reader



PRICE
£1300⁰⁰

Example installation in door pull handle and in door



Fingerprint reading + bluetooth EKEY
(can be controlled and programmed from a smartphone)

PRICE
£1310⁰⁰

TECHNICAL SPECIFICATION

Door size	S	So	Ss	Sz	H	Ho (Hp)	Ho (HpA)	Hs	H _z (Hp)	H _z (HpA)
"80"	780	980	825	900	1998	2120	2094	2036	2100	2074
"90"	880	1030	925	1000	1998	2120	2094	2036	2100	2074
"100"	980	1130	1025	1100	1998	2120	2094	2036	2100	2074

Vertical cross-section of the door leaf and frame

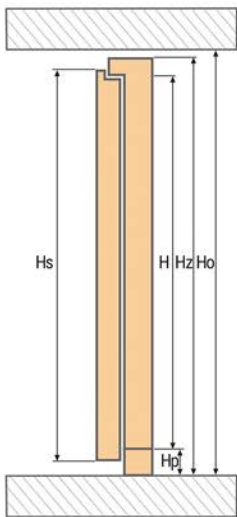

Horizontal cross-section of the door leaf and frame

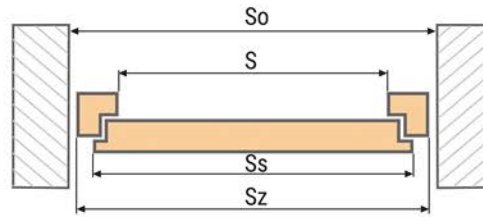

Left door

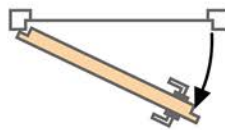

Right door

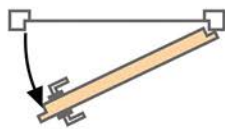

Legend – dimensions (mm)

- S - width inside frame
- So - the width of the opening in the wall
- Ss - width of door leaf.
- Sz - exterior width of the door (door leaf and frame)
- H - Height inside frame
- Ho - Height of the opening in the wall
- Hs - Height of door leaf
- H_z - exterior height of door (door leaf and frame)
- Hp - wooden threshold (42 mm)
- HpA - aluminium threshold (20 mm)

Threshold fitted with aluminium

PRICE £35⁰⁰

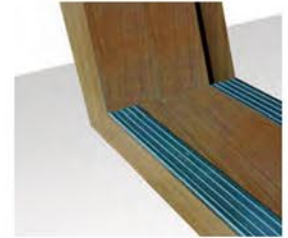

Aluminium thermal threshold (90mm)



PRICE £75⁰⁰

Kickplate nr 1 (160 mm)

PRICE £65⁰⁰



Kickplate nr 2 (110 mm)

PRICE £70⁰⁰



ADJUSTABLE FRAME

The adjustable frame allows you to fully cover the entire thickness of the wall. Standard door frames are made of wood. Additional INOX or GLASS trim options available which match decorative trim installed on the door.



e.g., adjustable door frame with "GLASS" application

Signboard thickness	A Adjustable frame		B Adjustable frame with application INOX		C Adjustable frame with application GLASS	
	200 - 300 mm	301 - 500 mm	200 - 300 mm	301 - 500 mm	200 - 300 mm	301 - 500 mm
OAK PLUS	£460	£535	£535	£600	£600	£675

LEVER HANDLES ⁺

COMFORT HANDLE RECOMMENDED

AXA NIAGARA WEST ⁺

8

Color
brassHANDLE
£60⁰⁰ UPPER PLATE
£35⁰⁰

8

Color
INOXHANDLE
£60⁰⁰ UPPER PLATE
£35⁰⁰

PROTECTION INSERTS

AXA ROYAL FLEX

12

Color
brassHANDLE
£110⁰⁰ UPPER PLATE
£65⁰⁰

12

Color
INOXHANDLE
£110⁰⁰ UPPER PLATE
£65⁰⁰III KLASA
ANTYWŁAMANIOWOSCI

AXA HAGA ⁺ 8

Color
INOXHANDLE
£55⁰⁰Color
brassUPPER PLATE
£35⁰⁰

AXA PRESTIGE ⁺ 12

Color
INOXHANDLE
£90⁰⁰Color
brassUPPER PLATE
£50⁰⁰III CLASS
ANTI-BURGLARY

The handle spacing for doors with a standard lock is 72mm and doors with a strip lock 92mm.



Symbol means that all handles marked with it have a handle levelling mechanism.

10% CHEAPER

When you buy a set of fittings (Axa handles+ Wilka inserts), drilled mounting holes for fixing screws are always included! Plus, buying a complete set saves you 10% off the price.

Electronic monitor

PRICE
£120⁰⁰



Door closer

PRICE
£135⁰⁰



Concealed door closer

PRICE
£355⁰⁰ K FUNCTION
+£100⁰⁰



Door viewer

PRICE
£20⁰⁰



Switch

PRICE
£35⁰⁰



CAPS AXA

PRICE
£35⁰⁰

Colour
INOX



Colour
brass



**Cylinder set prices
Cylinder + cylinder-knob**

Plate thickness	Class	Frame and panel doors		Panel doors	
		72mm	82mm	78mm	88mm
8 mm	„B”	£90	£95	£100	£105
8 mm	„C”	£100	£105	£105	£110
12 mm	„B”	£95	£105	£105	£110
12 mm	„C”	£105	£110	£110	£120

Wilka cylinders



Color
brass



Color
nickel



Colour
nickel + doorknob RAL



One key system
(6 keys included)

Cylinder-knob prices*

*recommended for strip locks without upper lock

Panel thickness	Class	Frame and panel doors		Panel doors	
		72mm	82mm	78mm	88mm
LM	„B”	£75	£85	£80	£95
LM	„C”	£85	£95	£90	£105
WP	„B”	£70	£75	£80	£85
WP	„C”	£80	£80	£85	£90

Door thickness	Frame-and-panel doors				Panel doors			
	Thickness 72 mm		Thickness 82 mm		Thickness 78 mm		Thickness 88 mm	
	external	internal	external	internal	external	internal	external	internal
8 mm	50/40g	40/50g	50/50g	50/50g	50/45g	45/50g	50/55g	55/50g
12 mm	55/40g	45/50g	55/50g	50/55g	55/45g	50/50g	55/55g	60/50g
LM	65/40g	-----	65/50g	-----	65/45g	-----	65/55g	-----
WP	45/40g	35/50g	45/50g	45/50g	45/45g	40/50g	45/55g	50/50g

* - 8 mm: CERES SOLO, NIAGARA WEST, HAGA

** - 12 mm: AXA PRESTIGE, AXA ROYAL FLEX or dedicated AXA SOLO 2 GAJA handle

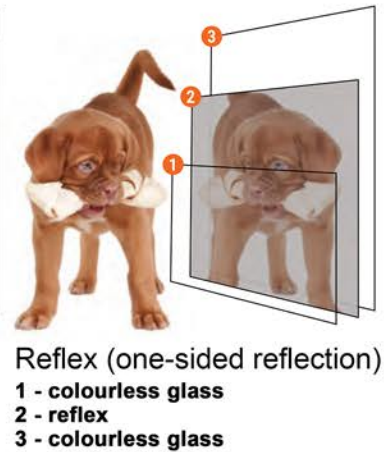
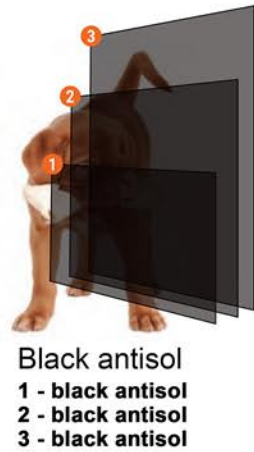
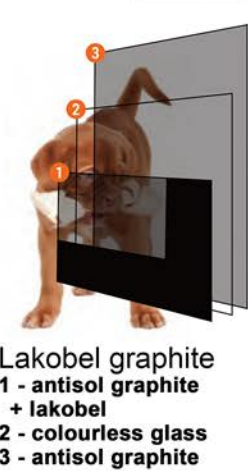
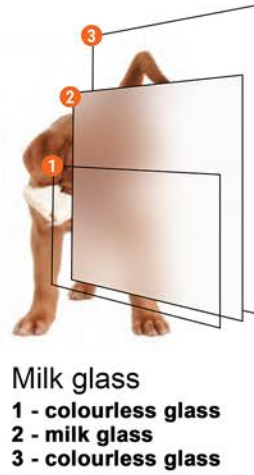
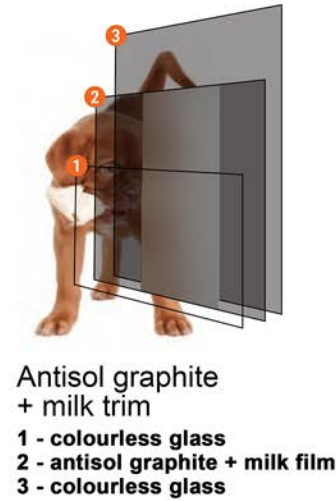
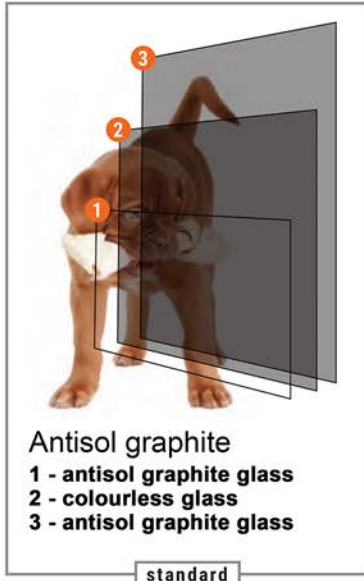

DAY

NIGHT

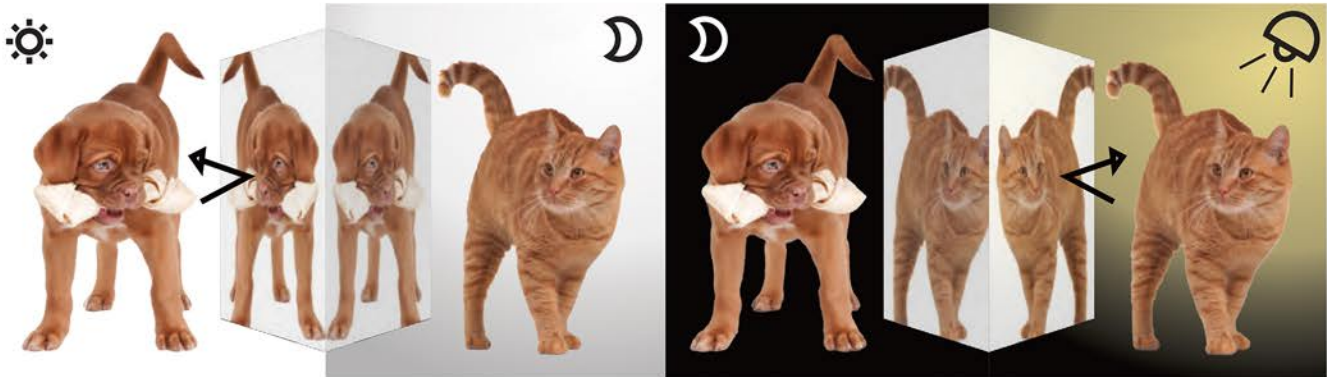

daytime (left side) VENETIAN MIRROR nighttime (right side)





17 The Precinct High Street
Rushden, NN100QU
Northamptonshire

Call our Sales Advisors

T: 01933 413 817

T: 07483 391 546

E: info@homeefe.co.uk

www.homeefe.co.uk

